

Assemble Me

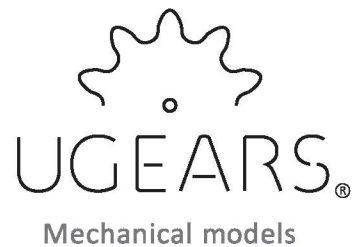

Model «Archballista-Tower» Модель «Вежа-аркбаліста»

DEU Modell «Turmballista». FRA Modèle «Arbalète à Tour».
POL Model «Wieża Arkbalista». SPA Modelo «Torre de balista».
ITA Modello «Torre Balestra». TUR Model «Mancınık Kulesi».
RUS Модель «Башня-аркбаллиста». KOR 발리스타 타워.
CHI 弩炮塔.

Assembly instructions Інструкція зі складання

DEU Aufbauanleitung. FRA Notice d'assemblage.
POL Instrukcja montażu. SPA Instrucciones de montaje.
ITA Istruzioni di montaggio. TUR Kurulum talimatı.
RUS Инструкция по сборке. KOR 조립 설명서.
CHI 装配说明书

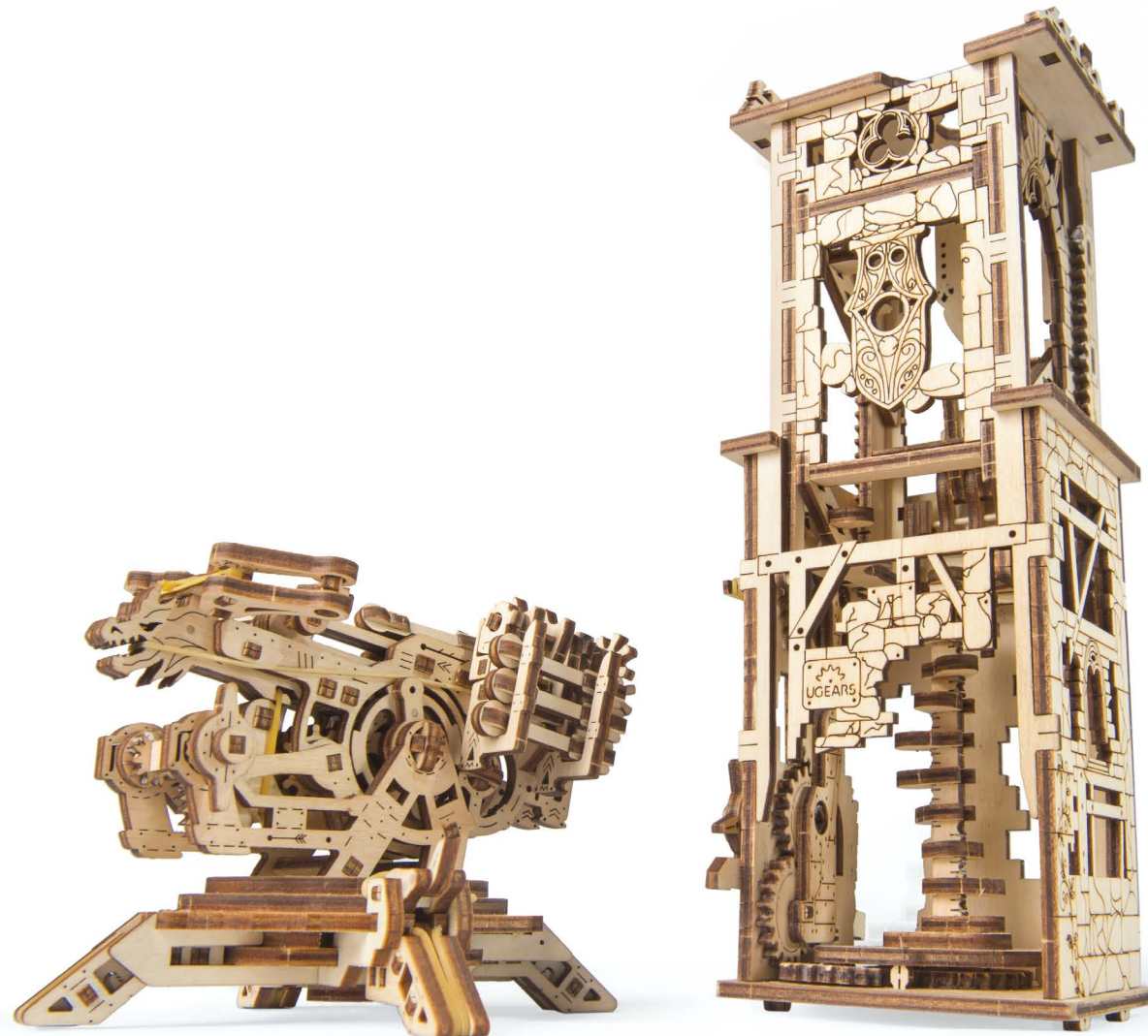

ENG

Assembly instructions:
Remove model parts from the hanger board as illustrated below. Careful not to break parts. If a part does not remove easily, carefully cut it out with a knife. This model is intended for self-assembly without glue. If you have difficulty installing the axles, try waxing them with a regular candle. All moving parts can also be waxed during assembly to reduce friction when operating the model.

UKR

Інструкція зі складання:
Витягніть з дошки позначені на схемі деталі. Намагайтеся їх не зламати. Якщо деталь не виймається, надсічіть перемички ножом. Конструкція збирається без клею. У разі виникнення труднощів з протягуванням зубочистки (вісі) в отвір, потріть зубочистку об звичайну свічку. Також можна змастити свічкою всі деталі механізму, щоб зменшити тертя при обертанні.

DEU

Aufbauanleitung:
Bitte die in der Zeichnung angegebenen Teile aus der Platte herausnehmen. Versuchen Sie bitte diese nicht zu brechen. Wenn sich ein Teil nicht herausnehmen lässt, schneiden Sie die Stege mit dem Messer leicht an. Das Modell wird ohne Klebstoffe zusammengebaut. Lässt sich eine Achse nur schwer in eine Öffnung einführen, reiben Sie diese mit einer Kerze etwas ein. Für besseres Gleiten schmieren Sie alle beweglichen Teile mit einer Kerze.

FRA

Notice d'assemblage:
Faites sortir de la planche les pièces comme indiquées sur le schéma. Tâchez de ne pas les casser. Si la pièce ne sort pas, incisez les collages/fixations avec un couteau. La construction est à assembler sans colle. Si il est difficile d'introduire l'axe en bois dans l'orifice, frottez au préalable l'axe ou les pièces contre une bougie. Pour améliorer le glissement, traitez les pièces de frottement mobiles du mécanisme avec une bougie au cours d'assemblage.

POL

Instrukcja montażu:
Delikatnie wyciągaj z deseczki wskazane w schemacie detale, starając się nie połamać elementów. Jeśli detal nie poddaje się, podetnij wiązadła nożem. Konstrukcje składa się bez kleju. Jeśli napotkasz trudności z instalacją drewnianej osi w otwór, potrzyj na początku oś lub detale o woskową świecę. Dla lepszego poślizgu polecano smarowanie ruchomych części mechanizmu zwykłą świecą podczas montażu.

SPA

Instrucciones de montaje:
Saque de la tabla las piezas marcadas en el esquema. Trate de no romperlas. Si una pieza no se saca, haga una incisión. La construcción va sin pegamento. Si tiene dificultades con la instalación del eje de madera en un agujero, frote primero el eje o las piezas contra una vela. Para un mejor deslizamiento, lubrique durante el montaje las piezas móviles del mecanismo con una vela común.

ITA

Istruzioni di montaggio:
Estrarre dal telaio i particolari indicati nello schema. Fare attenzione a non romperli. Se un particolare non si stacca, tagliare delicatamente gli elementi di collegamento con un coltello. L'assieme viene realizzato senza colla. In caso di difficoltà nell'inserimento di un perno in legno, è necessario sfregare il perno o il particolare con un po' di cera. Per uno scorrimento migliore increrare le parti mobili del meccanismo durante l'assemblaggio.

TUR

Kurulum talimatı:
Şemada işaretlenen parçaları tahtadan çıkarın. Kırılmamasına dikkat ediniz. Parça çıkarılmıyorsa bağlantı yerleri bıçakla kesiniz. Konstruksyon, yapıştırıcı kullanmadan yapılmaktadır. Tahta dingilini (kürdan) deliğin içine yerleştirmede zorluk çekiyorsanız önceden dingile veya parçalara mum sürünüz. Hareketli parçaların daha iyi kayması için kurulum sırasında parçalara mum sürünüz.

RUS

Инструкция по сборке:
Вынимайте из доски обозначенные на схеме детали. Старайтесь их не сломать. Если деталь не извлекается, надрежьте перемычки ножом. Конструкция собирается без клея. Если возникли трудности с установкой деревянной оси, перед установкой потрите детали об обычную свечу. Для лучшего скольжения смазывайте движущиеся детали механизма обычной свечой во время сборки.

KOR

조립 설명:
부품이 손상되지 않도록 주의하여 보드에서 떼어냅니다. 만약 부품이 잘 떨어지지 않으면 연결 부분을 칼로 절단 한 후 떼어내면 쉽게 떼어 낼 수 있습니다. 본 제품은 접착제가 없이 조립이 가능하도록 설계되어 있습니다. 만약 축이 잘 끼워지지 않는 경우 양초를 축에 바른 후 끼워보세요. 모든 구동 부위는 제품 구동 시 원활한 작동이 가능하도록 조립 과정에서 윤활제(양초)양초를 발라 주세요.

CHI

装配说明
将模型部件按插图示，从胶合板取下。小心不要损坏件。如果取下时候有难度，请用小刀小心的切割连接点。这个产品不需要胶水粘接。如果安装转轴的时候有难度，请用普通的蜡加以润滑。所有的转动部分也需要打蜡润滑。

ENG Warning! **UKR** Увага! **DEU** Achtung! **FRA** Attention! **POL** Uwaga! **SPA** Precaución!
ITA Attenzione! **TUR** Dikkat! **RUS** Внимание! **KOR** 주의! **CHI** 注意!



ENG Do not use a lighted candle! **UKR** Не підпалювати! **DEU** Nicht anzünden!
FRA Ne pas brûler! **POL** Nie podpalać! **SPA** ¡No encender! **ITA** Non dare fuoco!
TUR Yakmayınız! **RUS** Не поджигать! **KOR** 불이 붙은 초를 이용하지 마세요!
CHI 请勿点燃，请勿靠近火源!



ENG Caution! Axles have sharp points! **UKR** Обережно! Гострі деталі! **DEU** Vorsicht! Spitze Teile!
FRA Attention: certaines pièces sont pointues! **POL** Ostrożnie! Ostre części!
SPA ¡Atención! Piezas afiladas! **ITA** Attenzione! Particolari appuntiti!
TUR Dikkat! Keskin parçalar! **RUS** Осторожно! Острые детали! **KOR** 축의 뾰족한 부분에 주의하세요! **CHI** 注意! 注意! **CHI** 尖锐部件!

ENG Symbols. **UKR** Умовні позначення. **DEU** Legende. **FRA** Légende. **POL** Oznaczenia umowne.
SPA Leyenda. **ITA** Legenda. **TUR** Kararlaştırılan işaretler. **RUS** Условные обозначения. **KOR** 기호. **CHI** 图标含义



ENG Wax the part with a regular candle (rub with a candle). **UKR** Змастіть деталь звичайною свічкою (потріть об свічку). **DEU** Reiben Sie das Teil mit einer einfachen Kerze etwas ein. **FRA** Lubrifiez la pièce avec une bougie ordinaire (frottez contre la bougie). **POL** Przesmaruj zwykłą świecą. **SPA** Engrase la pieza con una vela común (frote con una vela). **ITA** Incerare il componente (sfregare con la cera). **TUR** Parçaya sade mum sürünüz. **RUS** Смажьте деталь обычной свечкой (потрите о свечку). **KOR** 표시된 부분에 윤활을 위해 초를 칠해 주세요. **CHI** 用普通蜡烛涂抹润滑部件。



ENG Pay attention. Check for correct orientation or positioning. **UKR** Зверніть увагу. Перевірте розташування елемента. **DEU** Bitte Beachten. Prüfen Sie die Einbaulage des Elementes. **FRA** Faites attention. Vérifiez la disposition de l'élément. **POL** Zwróć uwagę. Sprawdź lokalizację elementu. **SPA** Atención. Compruebe la situación del elemento. **ITA** Prestare attenzione. Controllare la posizione del componente. **TUR** Dikkat. Elemanın yerleşimini kontrol ediniz. **RUS** Обратите внимание. Проверьте расположение элемента. **KOR** 방향 또는 위치에 주의해서 조립해 주세요. **CHI** 注意！检查部件方向和位置



ENG Press the parts as far as they will go. **UKR** Притисніть деталі до упору. **DEU** Drücken Sie die Teile bis zum Anschlag. **FRA** Pressez les pièces à fond. **POL** Przyciśnij element, aż do oporu. **SPA** Pulse para detener las piezas. **ITA** Stingere bene i componenti. **TUR** Parçaları sonuna kadar sıkıştırınız. **RUS** Прижмите детали до упора. **KOR** 부품을 양쪽에서 눌러서 고정해 주세요. **CHI** 用力紧密结合部件



ENG The part should be easily rotated (moved). **UKR** Деталь повинна легко крутитися (рухатися). **DEU** Der Teil soll leicht gedreht (bewegt) werden. **FRA** La pièce doit tourner (se déplacer) aisément. **POL** Element powinien łatwo się kręcić (poruszać się). **SPA** La pieza debe ser fácil de girar (mover). **ITA** Il componente deve girare (muoversi) facilmente. **TUR** Parça kolayca dönmeli (hareket etmeli). **RUS** Деталь должна легко крутиться (двигаться). **KOR** 활하게 움직일 수 있어야합니다. **CHI** 此部件必须容易的旋转 (移动)

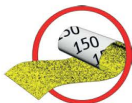

ENG Sand to remove burrs. **UKR** Видаліть задирки. **DEU** Grate entfernen. **FRA** Éliminez les bavures. **POL** Usun zadziory. **SPA** Quite las rebabas. **ITA** Togliere le bave. **TUR** Çapakları çıkartınız. **RUS** Удалите заусенцы. **KOR** 거친 부분을 다듬어 주세요. **CHI** 磨掉毛刺



ENG Break off or cut out. **UKR** Відламайте або відріжте. **DEU** Abbrechen oder Abschneiden. **FRA** Coupez ou cassez. **POL** Odłam lub odetnij. **SPA** Rompa o corte. **ITA** Staccare o tagliare. **TUR** Kirin veya kesin. **RUS** Отломайте или отрежьте. **KOR** 잘라내 주세요. **CHI** 切断



ENG Spare parts. **UKR** Запасні деталі. **DEU** Ersatzteile. **FRA** Pièces de rechange. **POL** Części zamienne. **SPA** Piezas de repuesto. **ITA** Pezzi di ricambio. **TUR** Yedek parçalar. **RUS** Запасные детали. **KOR** 여유 부품입니다. **CHI** 备用件

ENG Axle. **UKR** Біль. **DEU** Achse. **FRA** Axe. **POL** Oś. **SPA** Eje. **ITA** Perno. **TUR** Dingil. **RUS** Ось. **KOR** 축. **CHI** 轴承

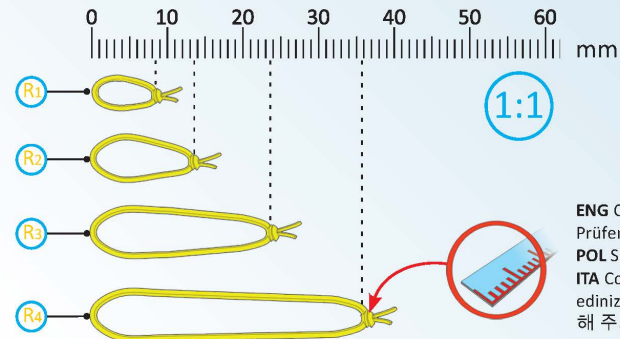

ENG Check size. **UKR** Перевірте розмір. **DEU** Prüfen Sie die Größe. **FRA** Vérifiez la dimension. **POL** Sprawdź rozmiar. **SPA** Compruebe el tamaño. **ITA** Controllare le dimensioni. **TUR** Boyutu kontrol ediniz. **RUS** Проверьте размер. **KOR** 크기를 확인해 주세요. **CHI** 測量尺寸

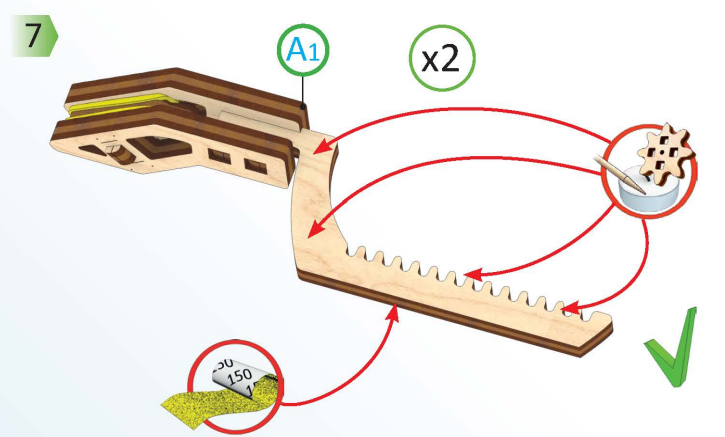
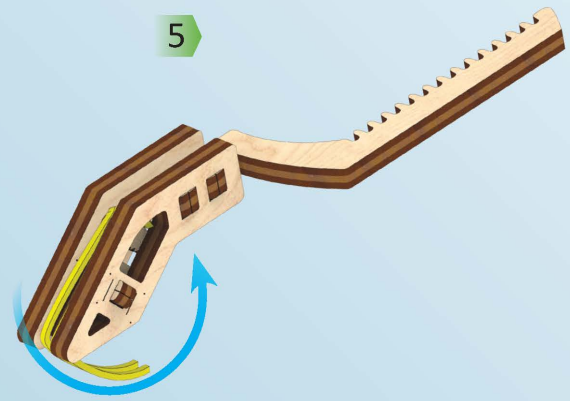
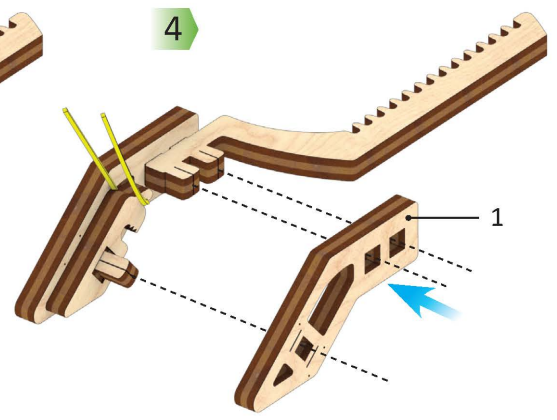
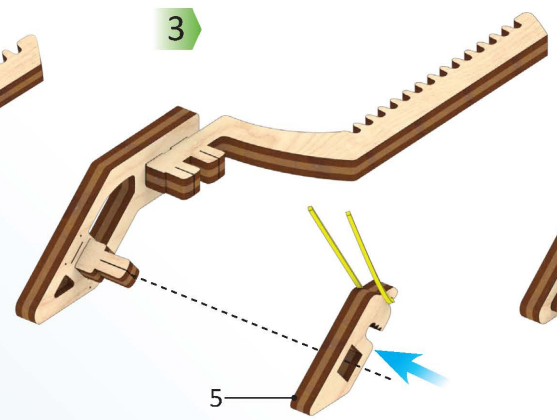
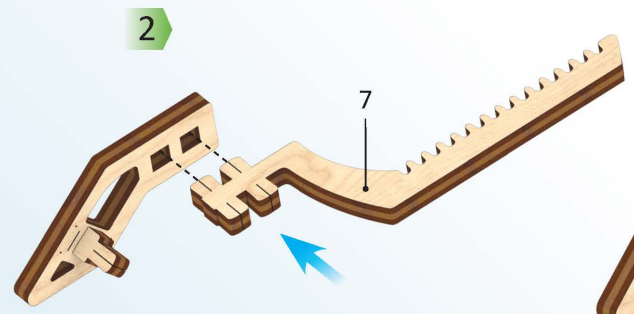
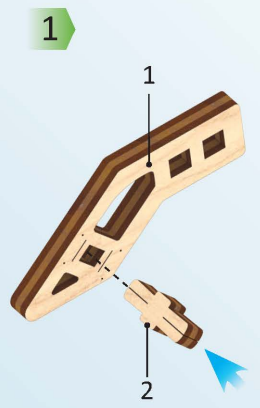
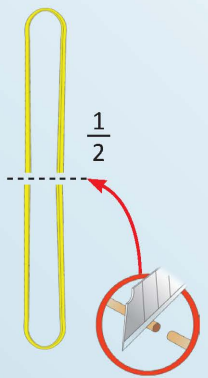
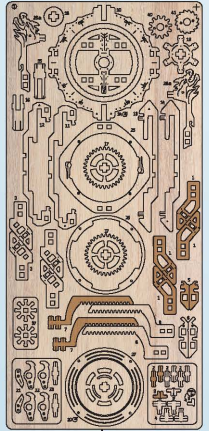

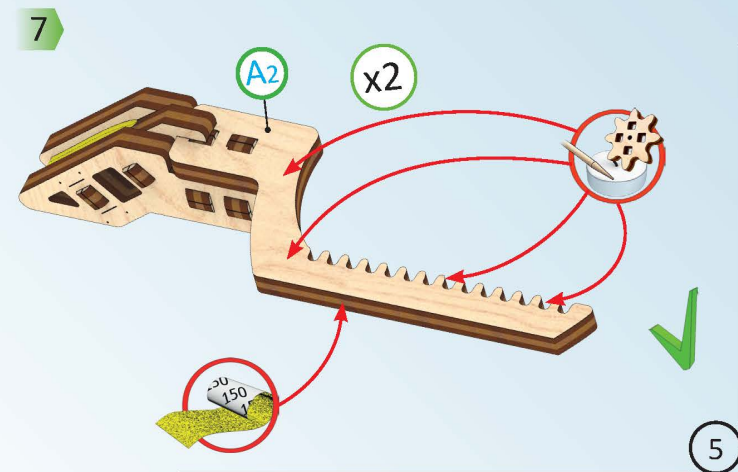
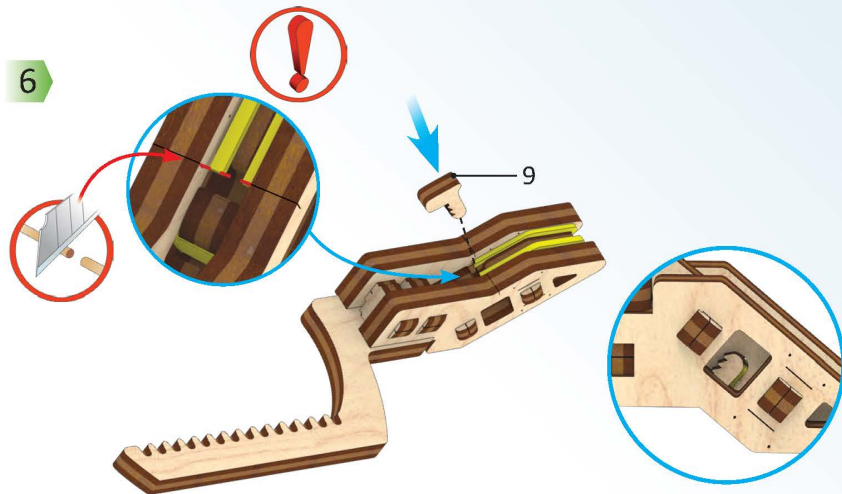
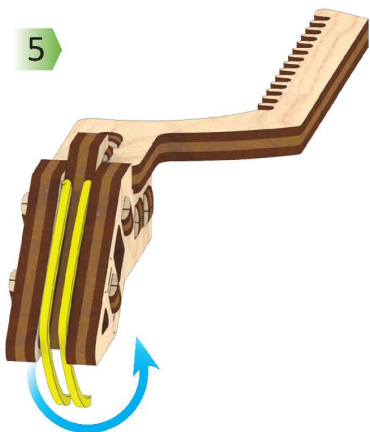
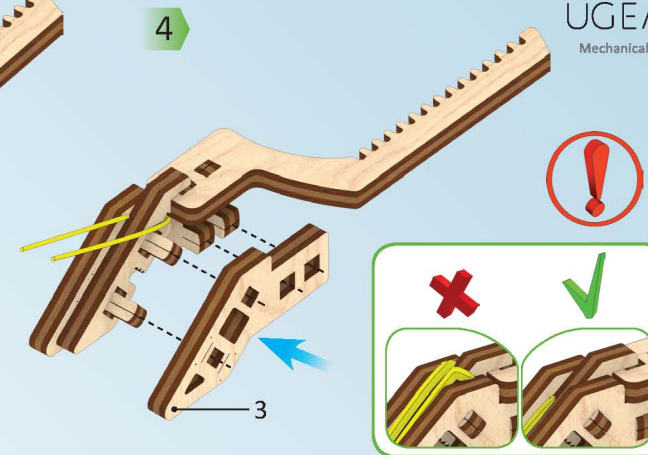
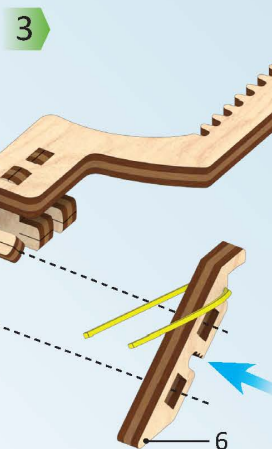
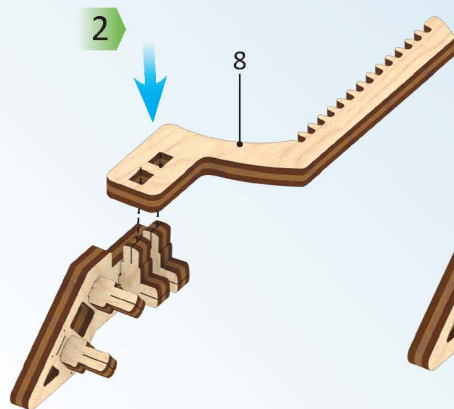
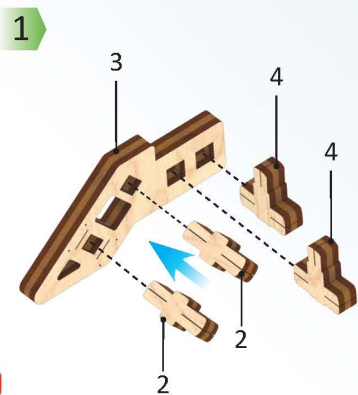
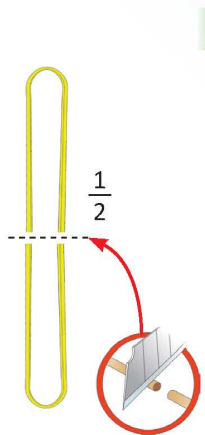
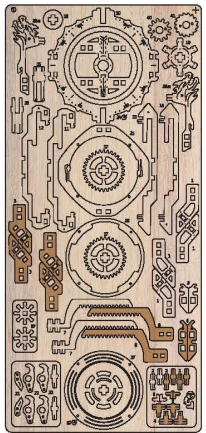

Mechanical models

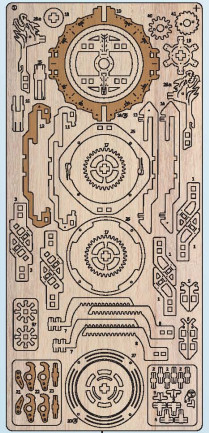

1

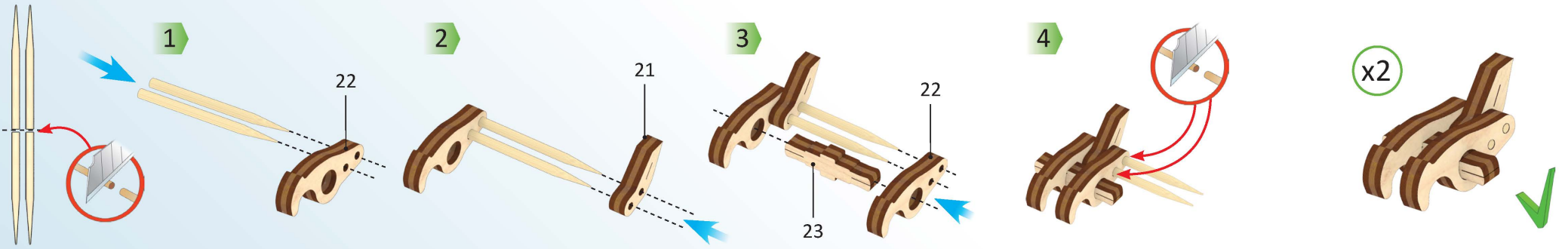

1

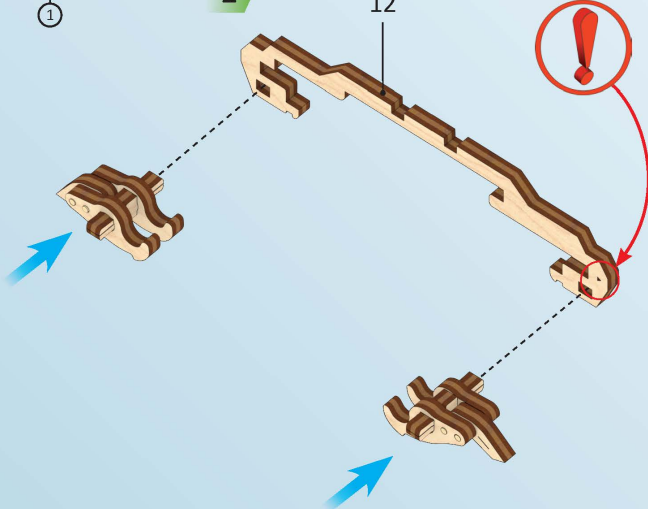

2

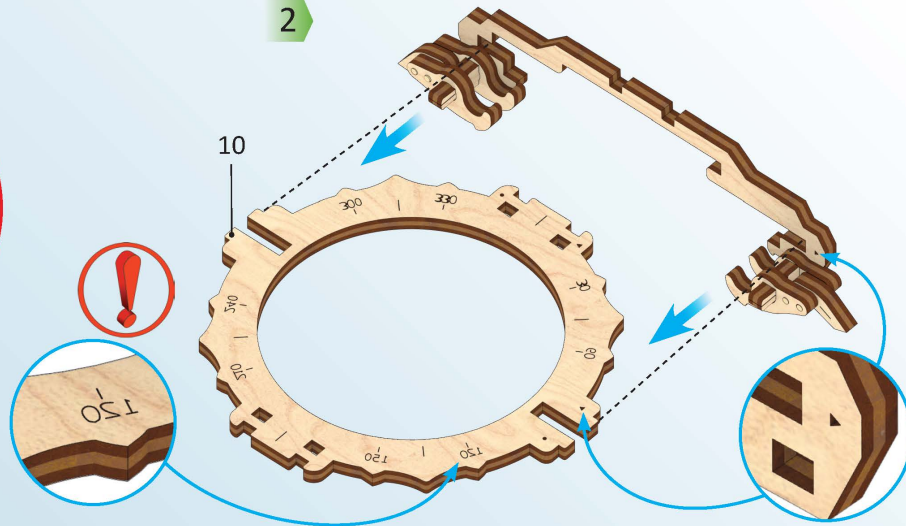

3

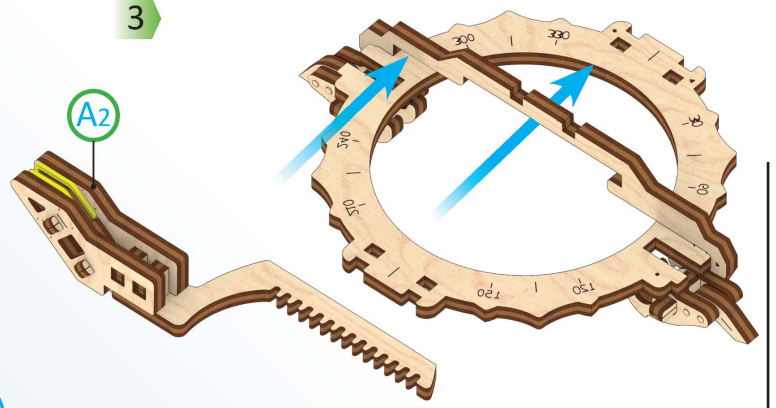

6

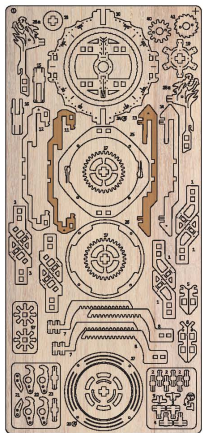

1

1

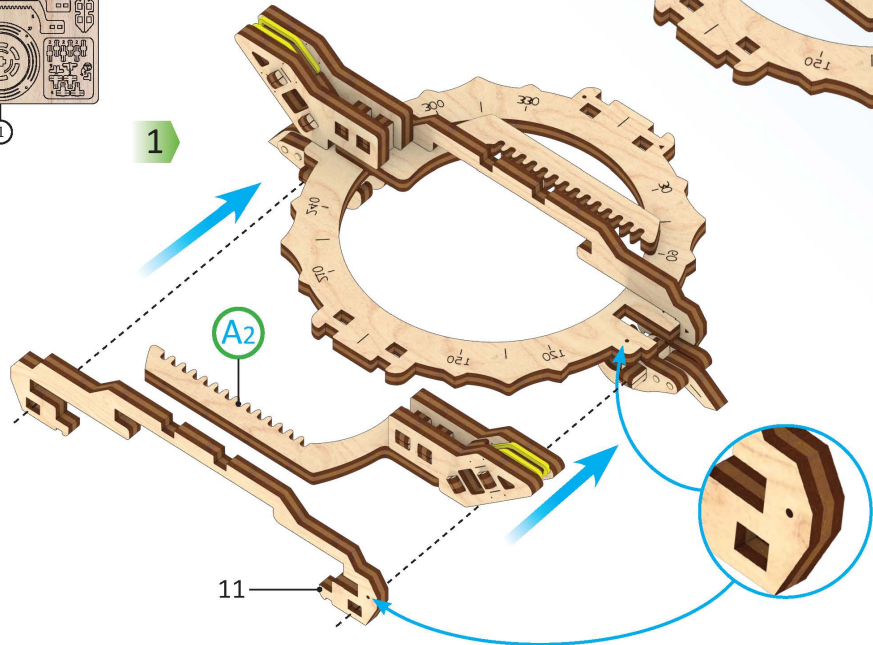

2

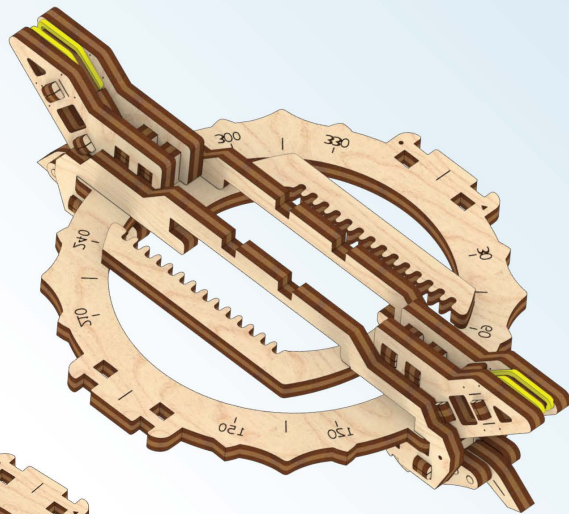

3

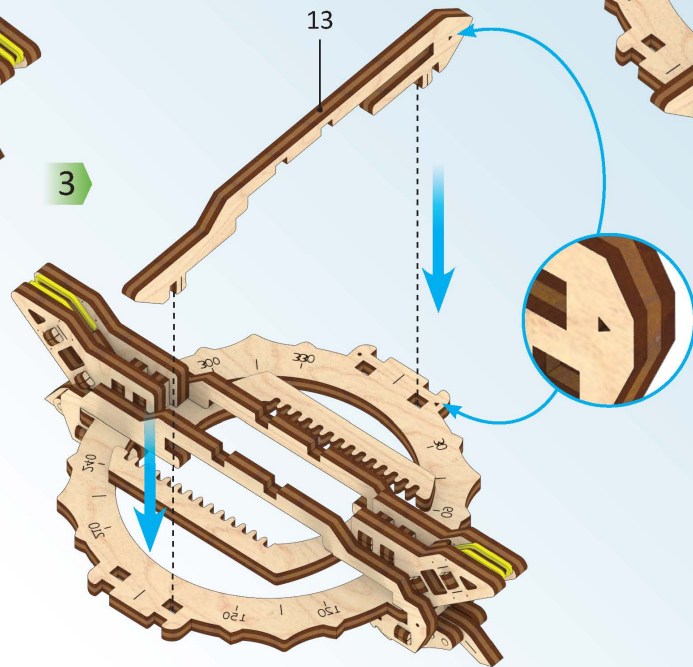

4

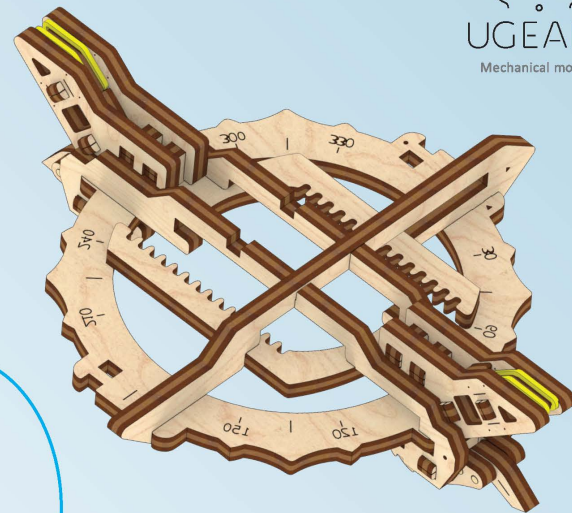

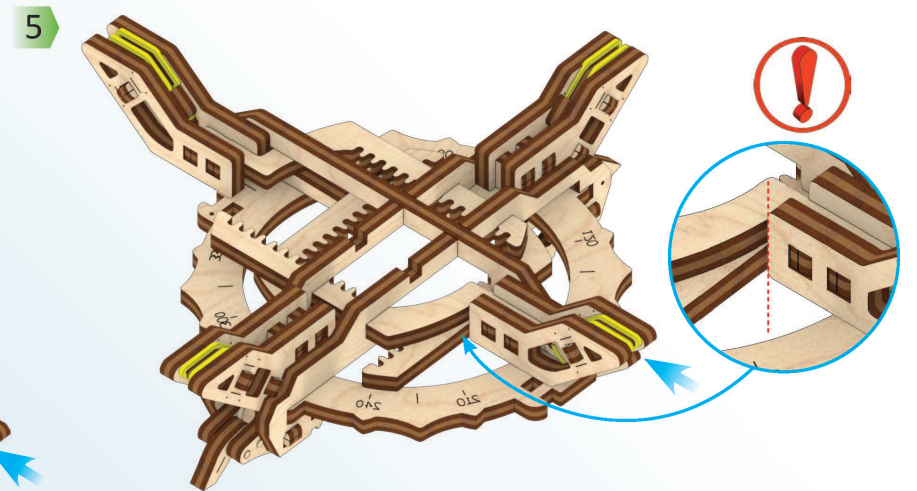
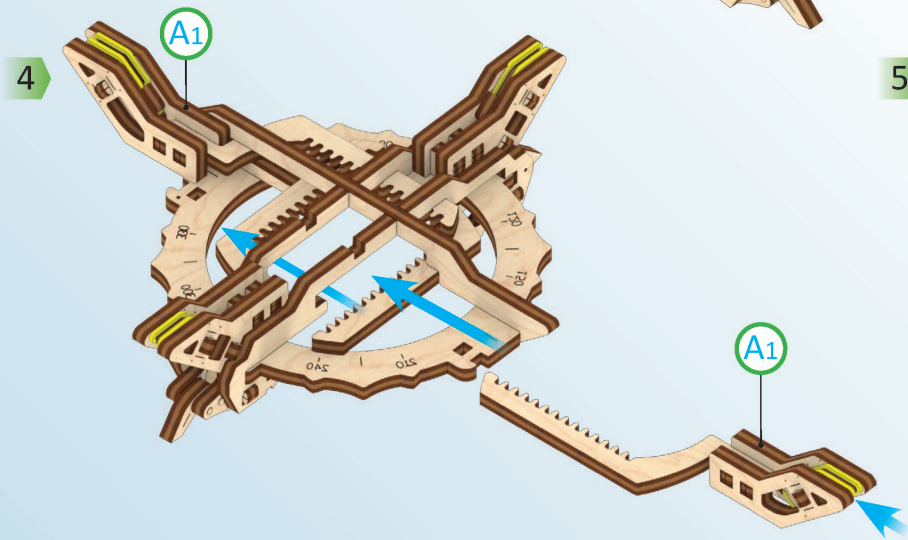
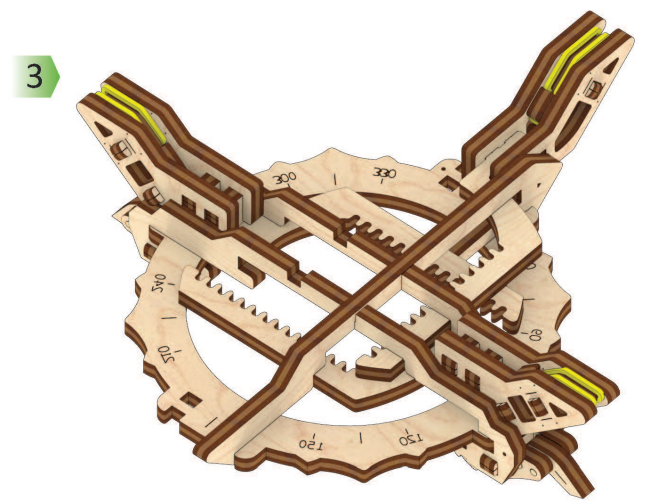
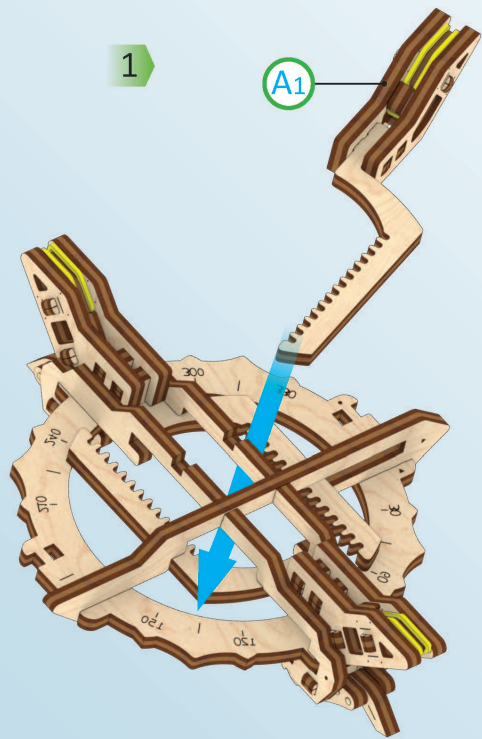

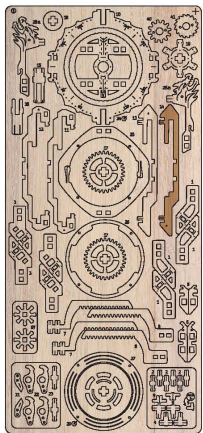

1

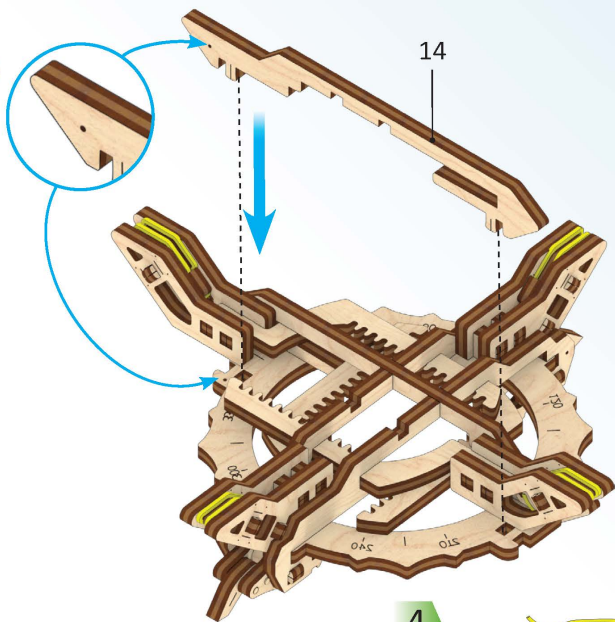

2

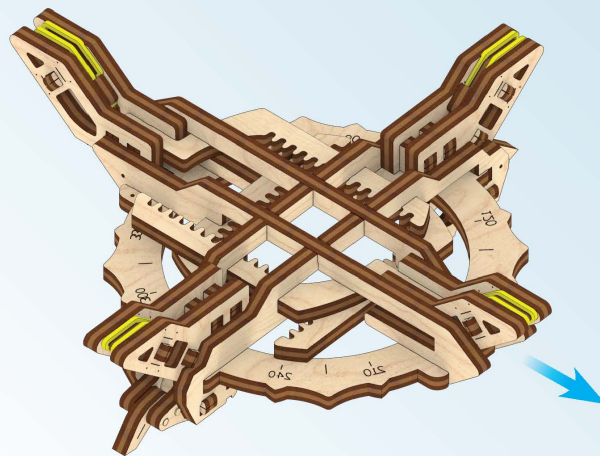

3

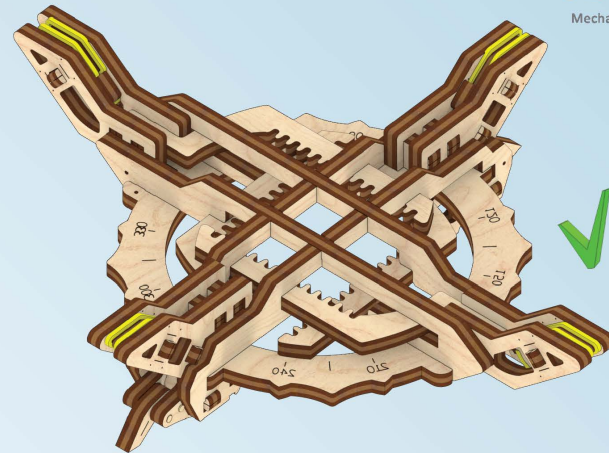

4

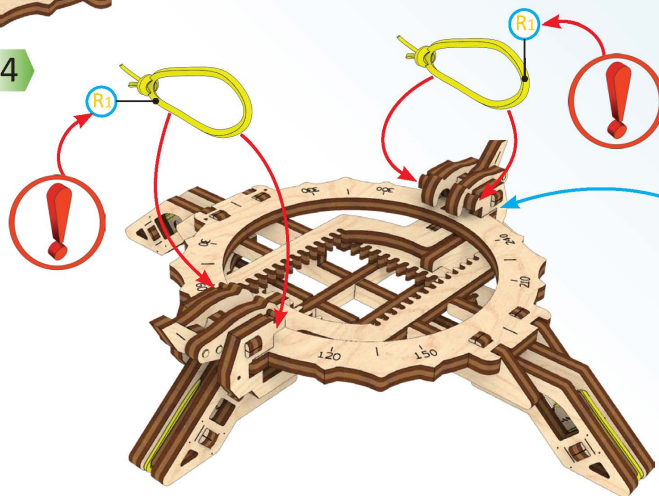

5

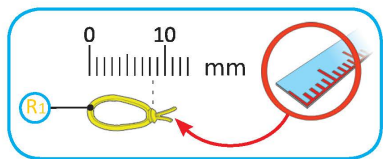
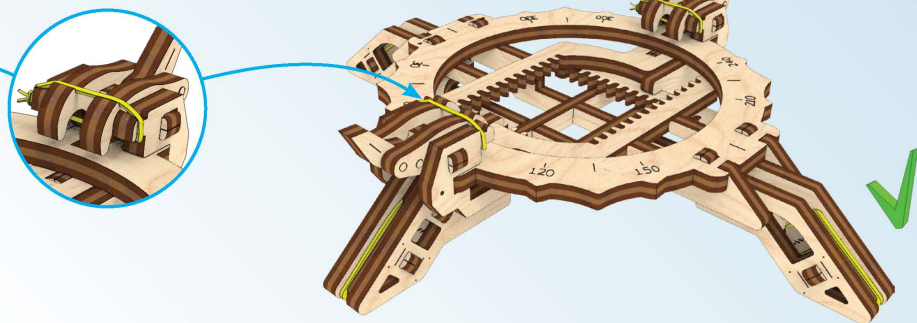

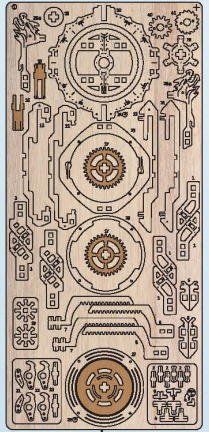

1

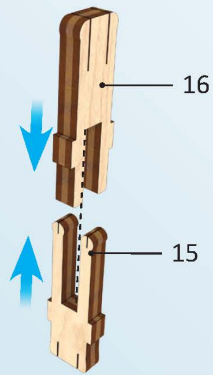

2

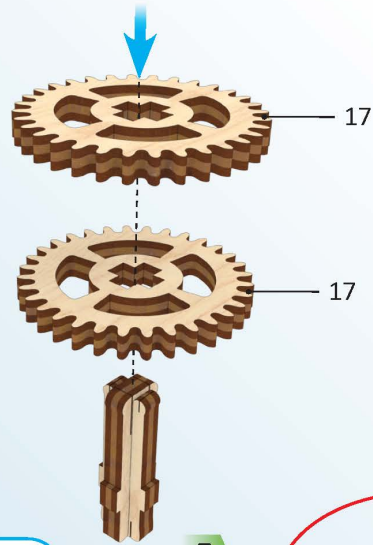

3

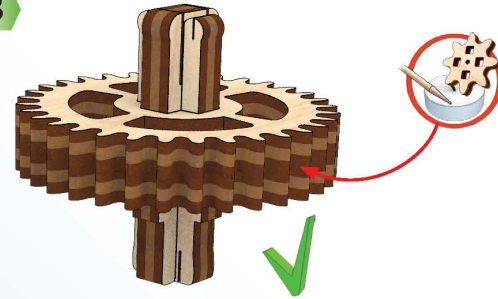

4

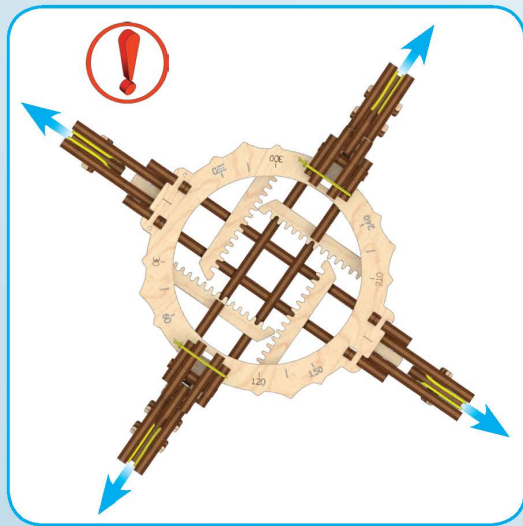

5

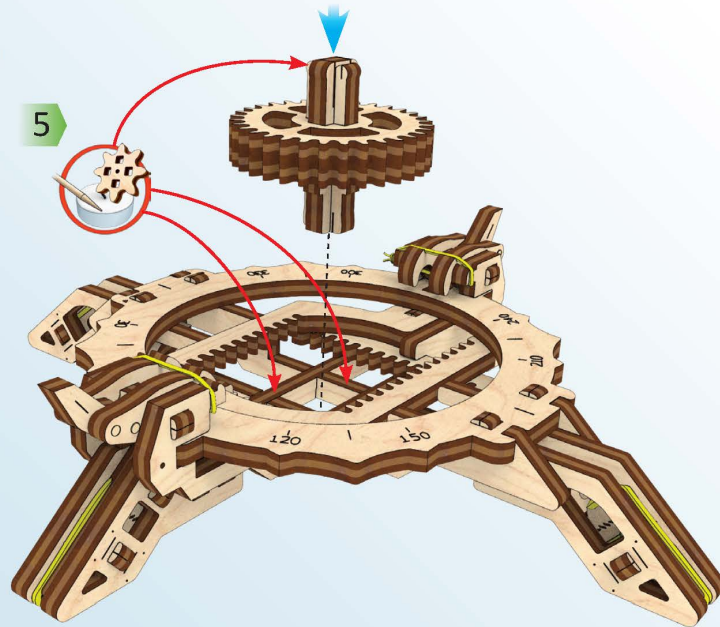

6

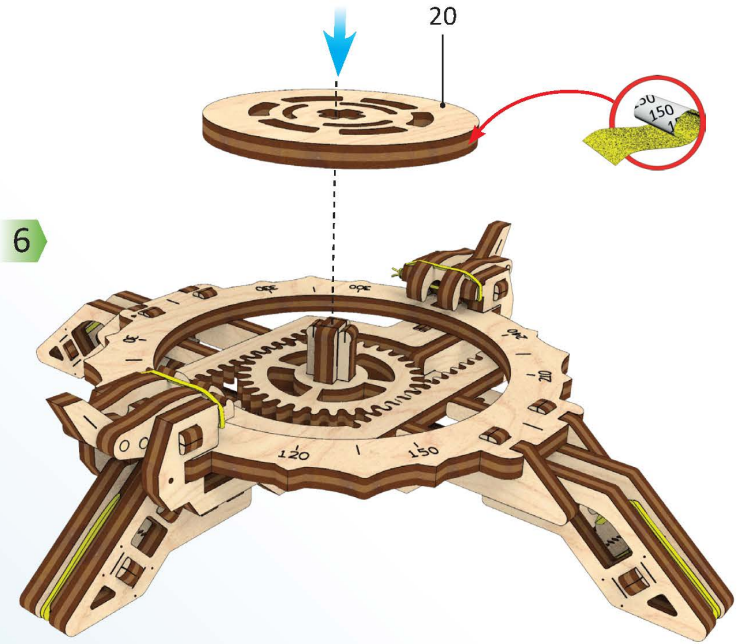

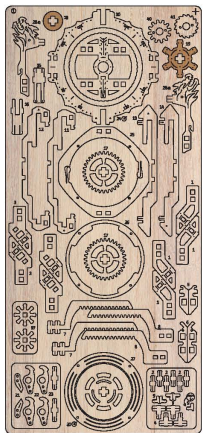

1

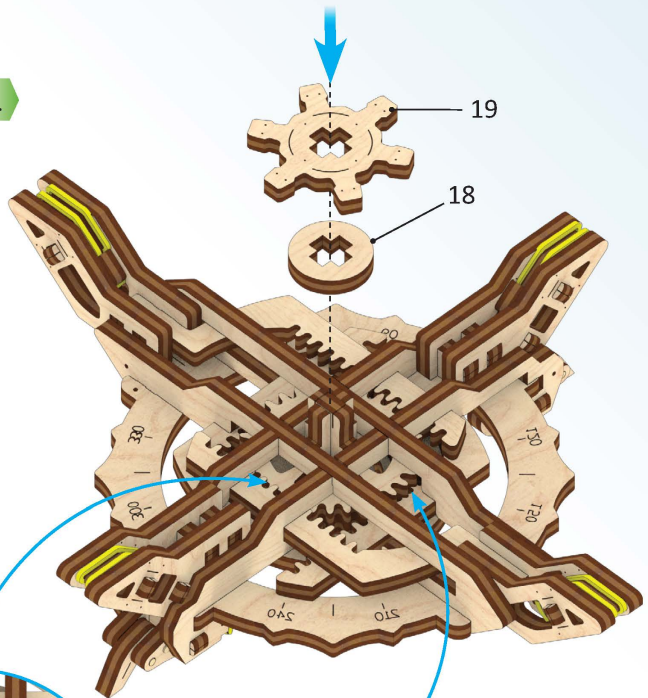
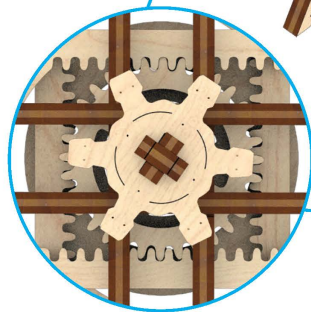

2



3

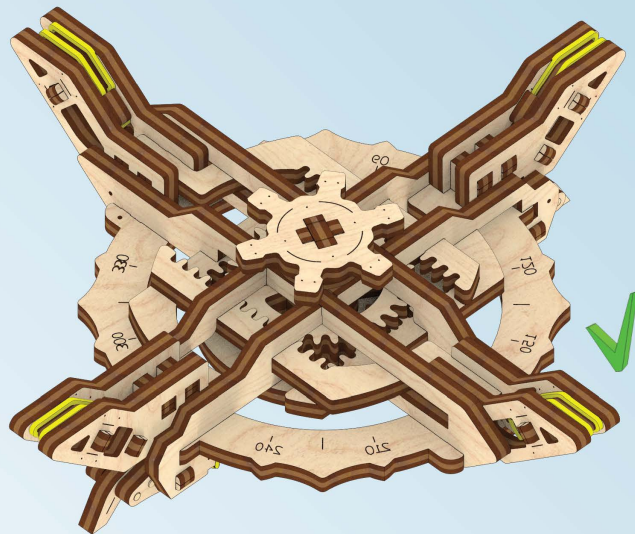

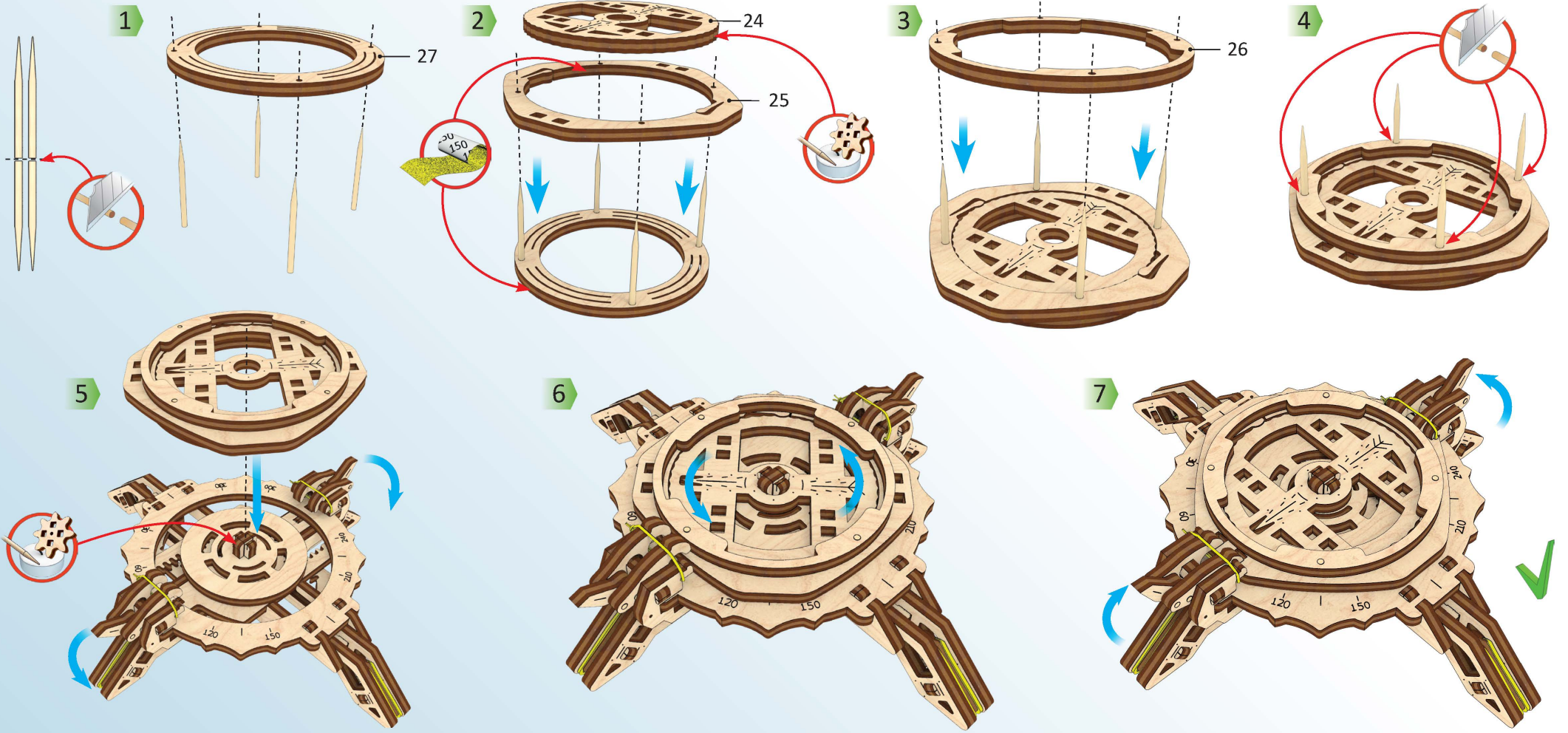
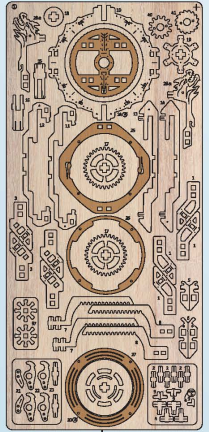

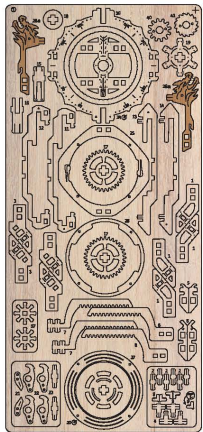

1

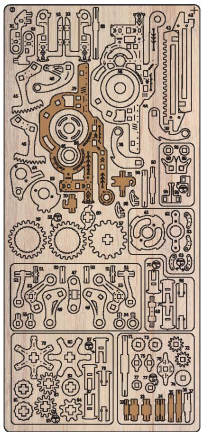

2

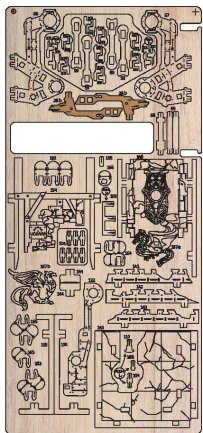

4

1

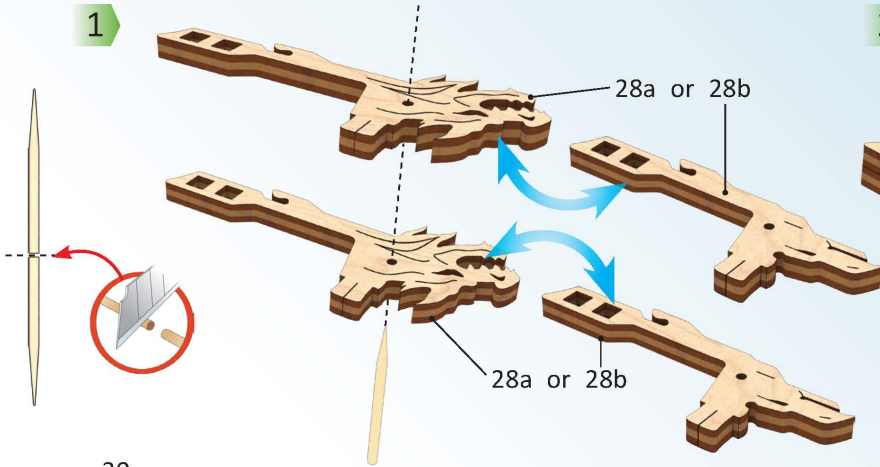

2

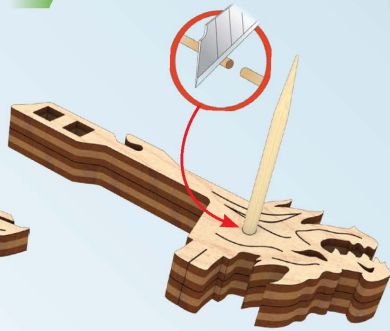

3

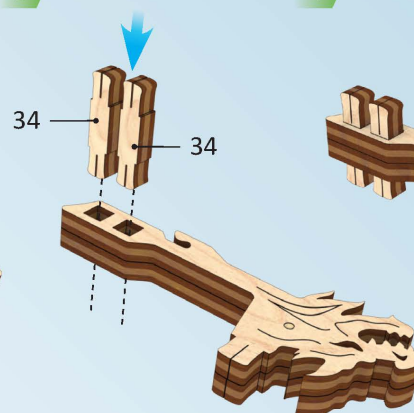

4

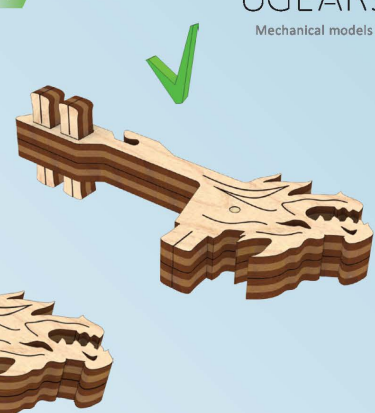

5

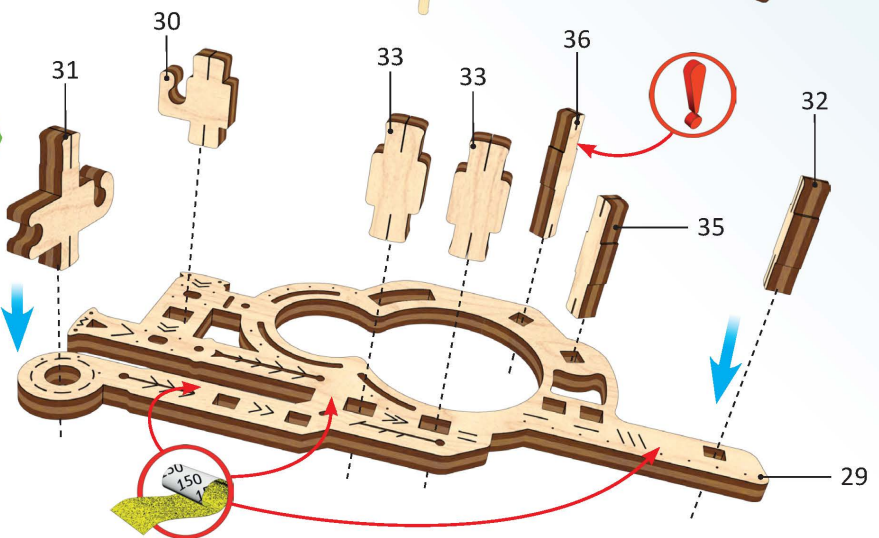

6

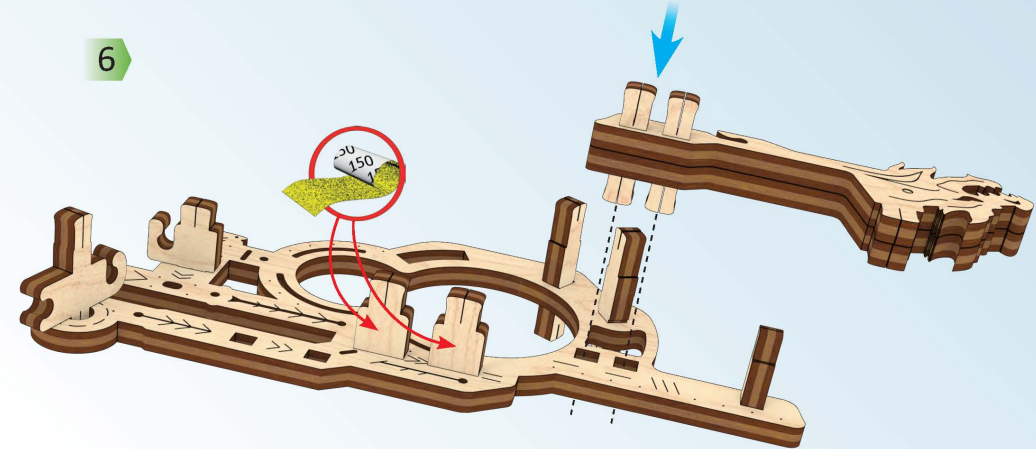

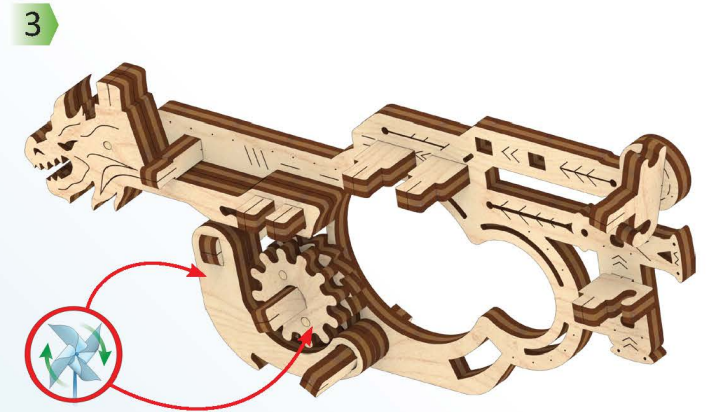
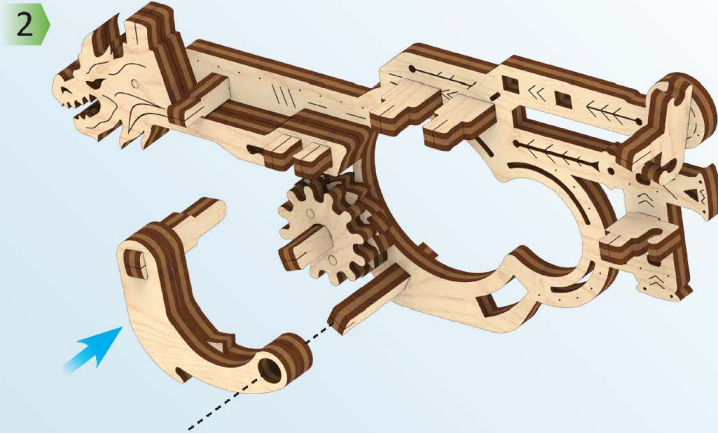
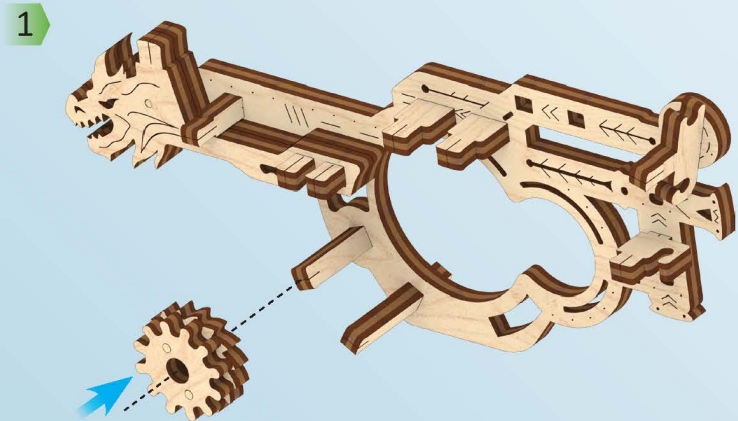
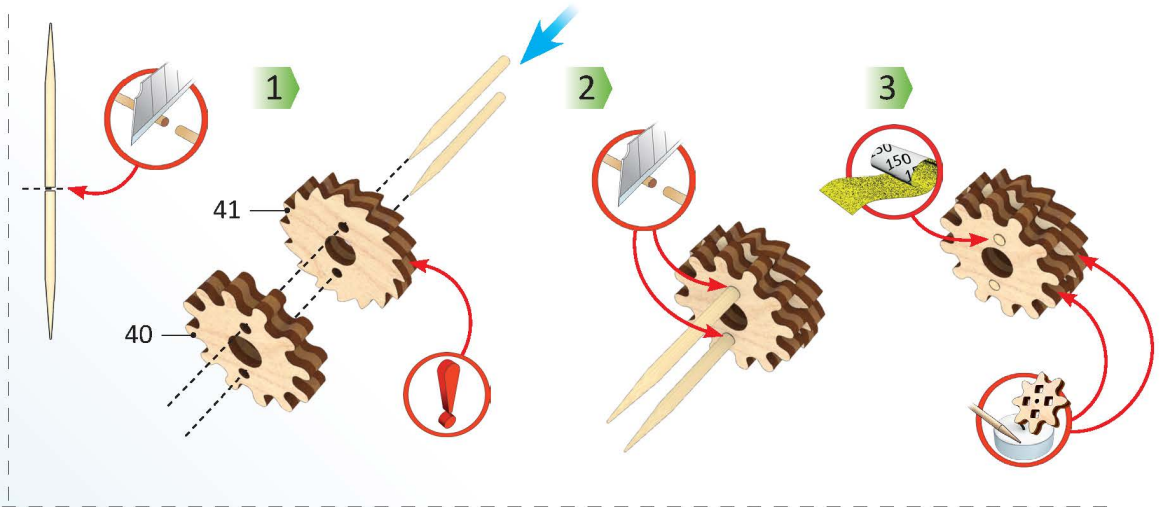
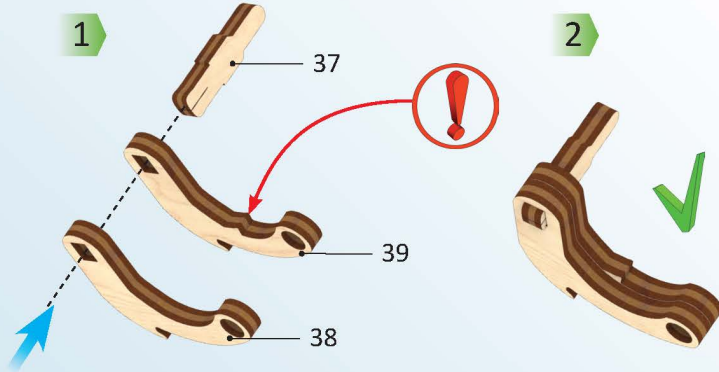
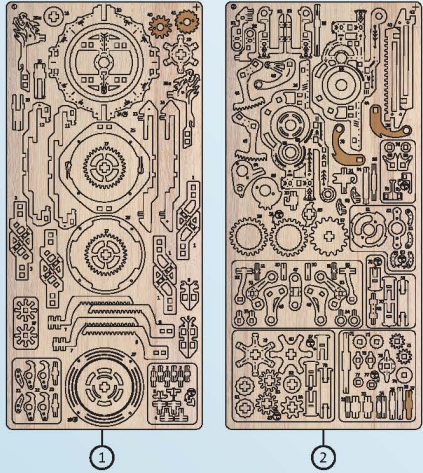

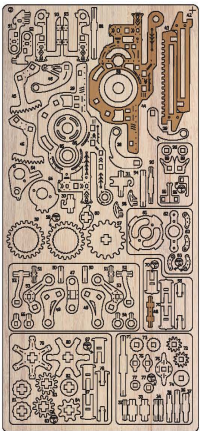

2

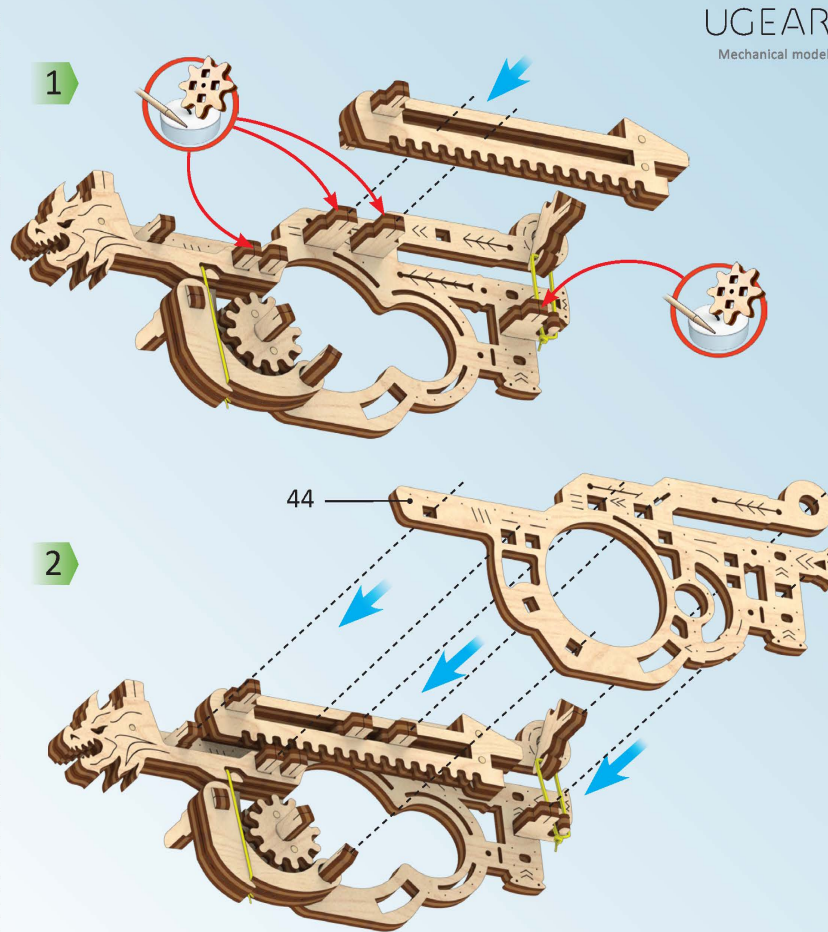
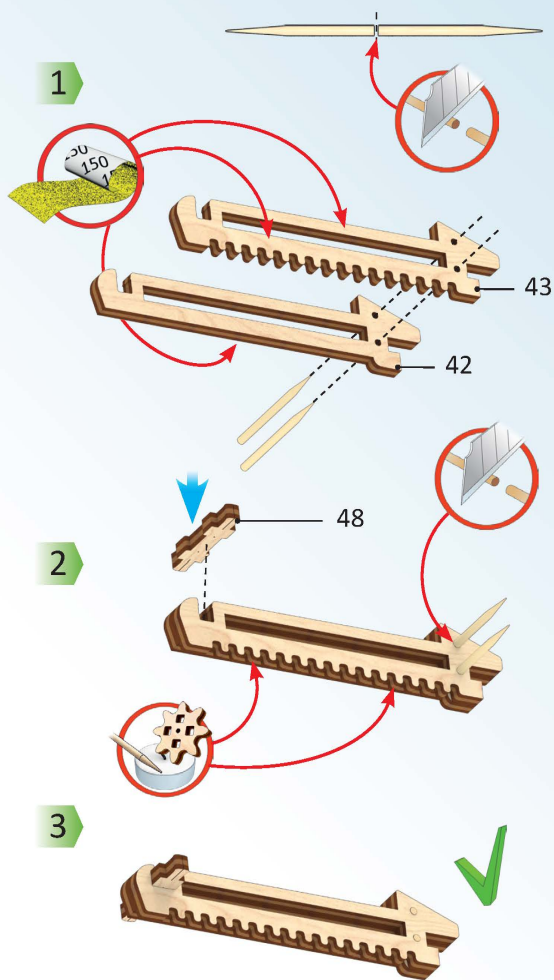
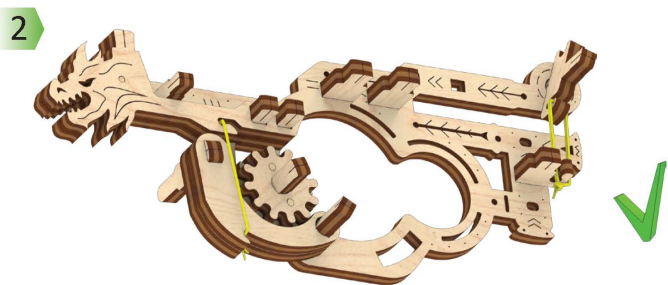
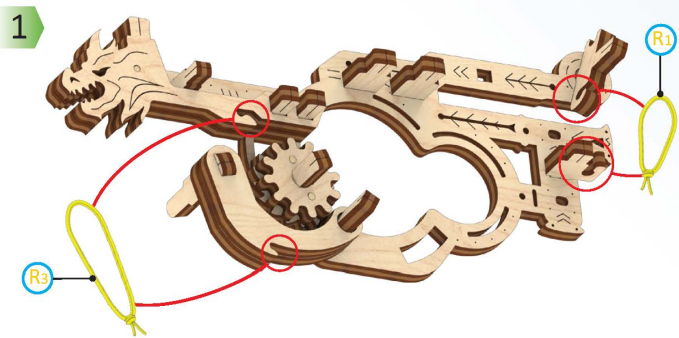
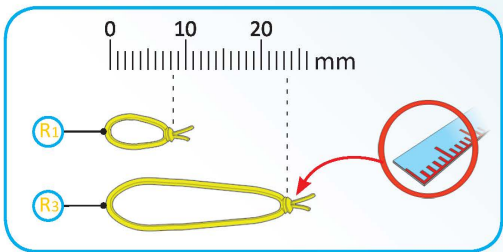

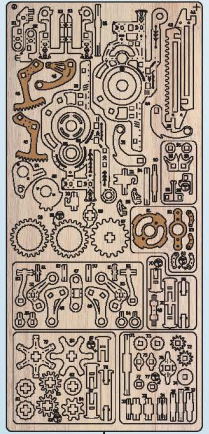

2

1

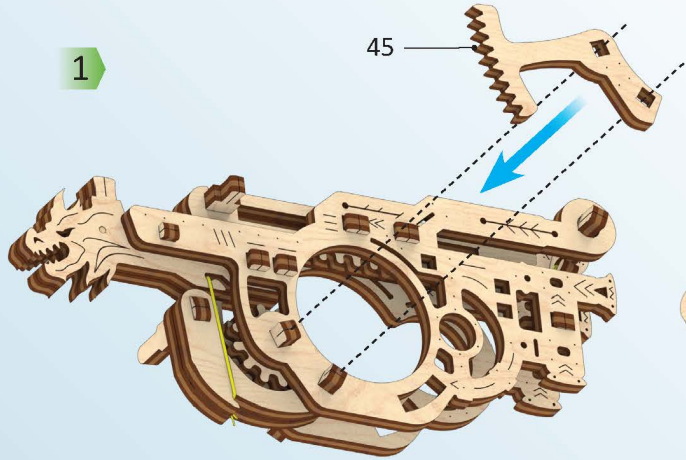

2

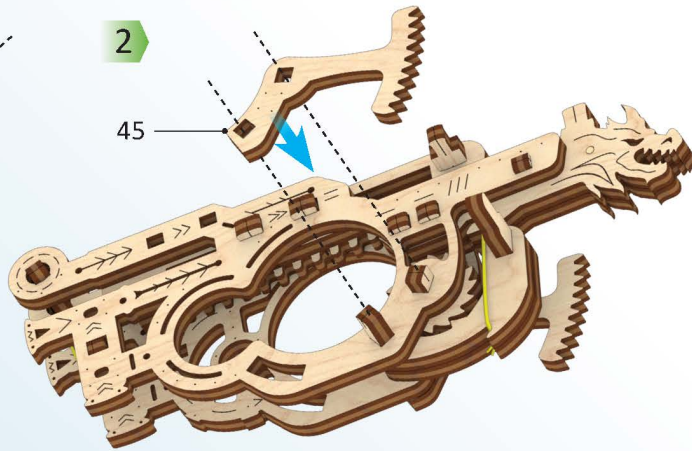

3

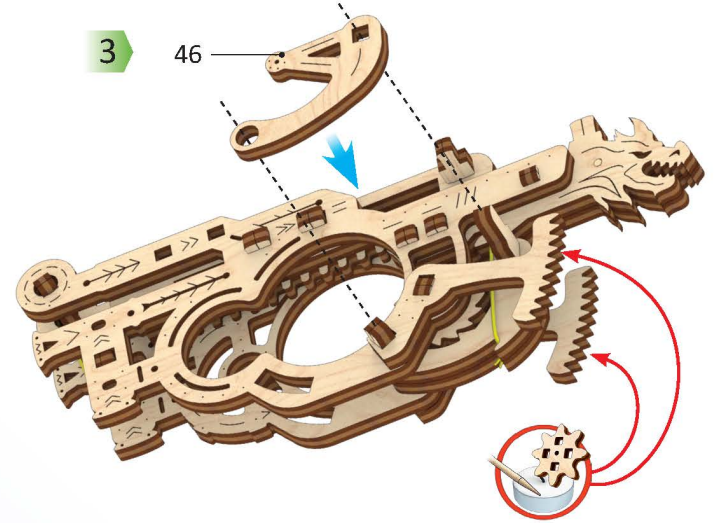

4

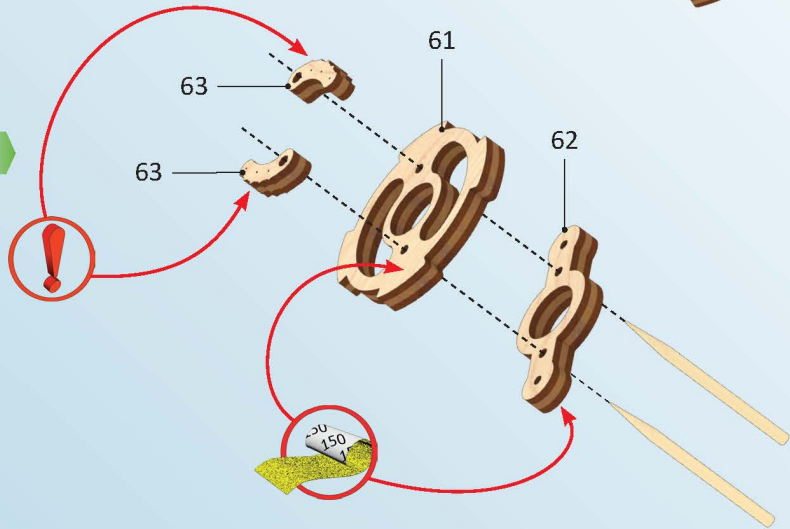

5

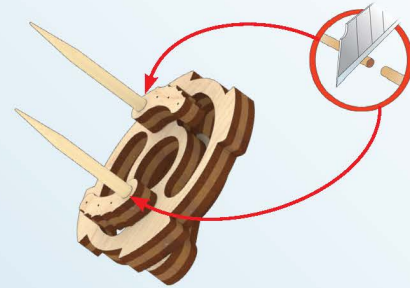

6

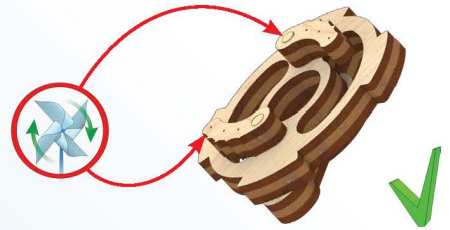

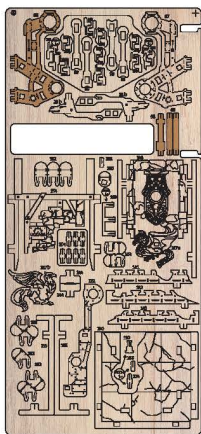
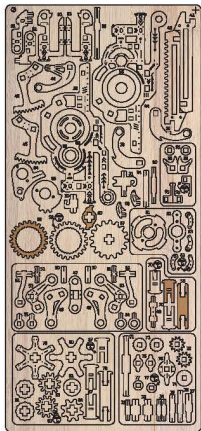

1

56

70

2

66

3

68

4

69

69

5

6

59

60

7

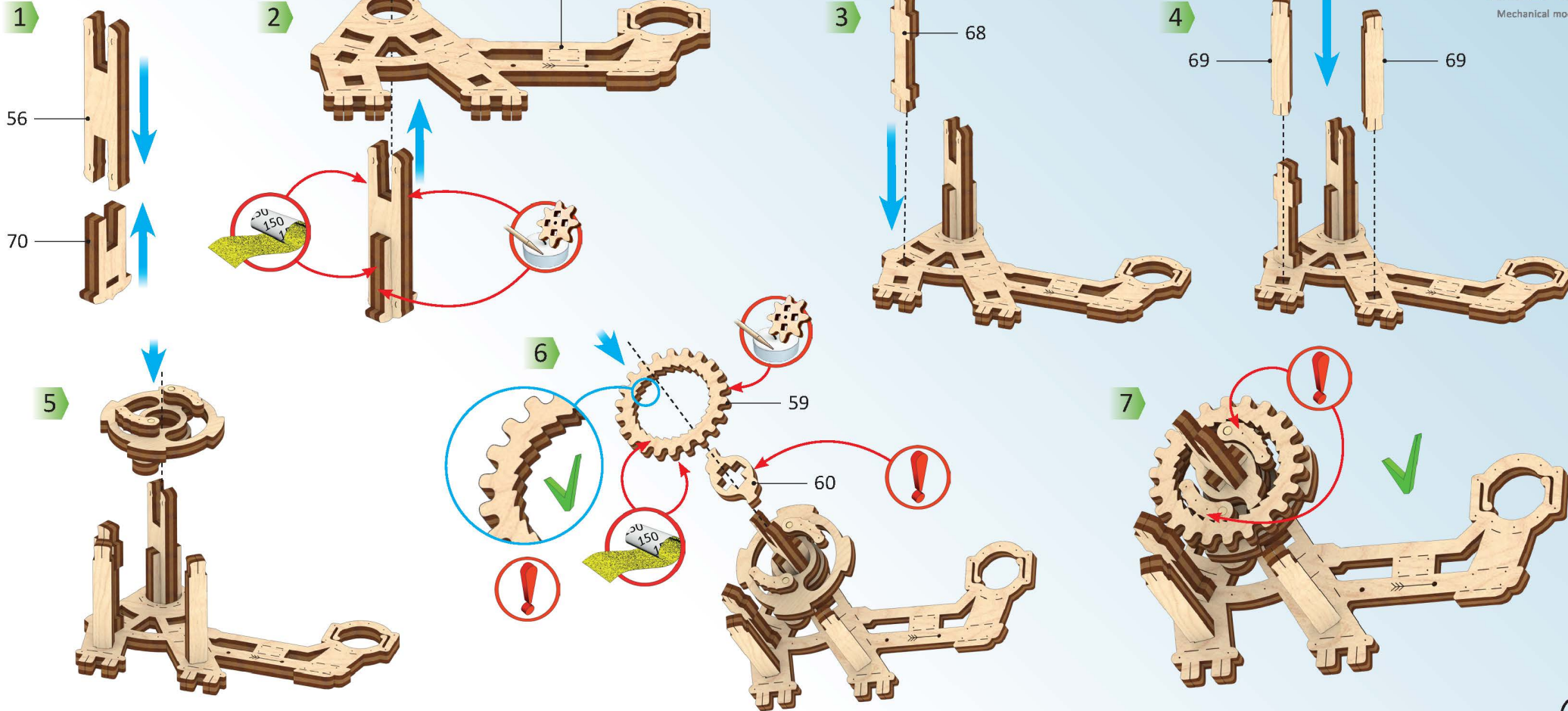

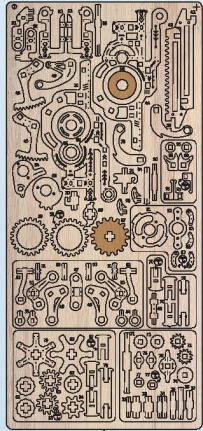

2

1

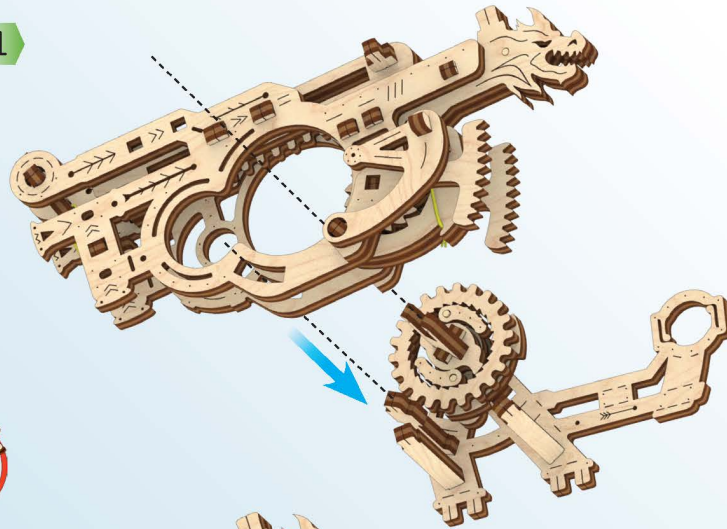

2

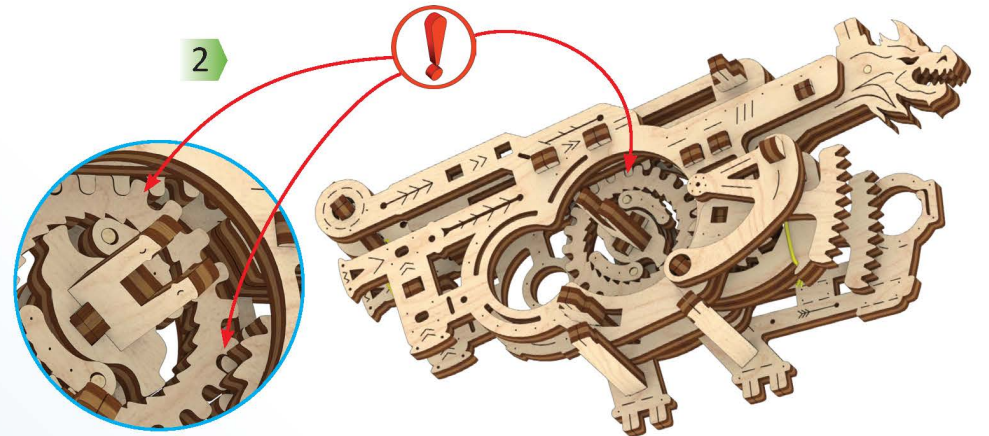

57

3

58

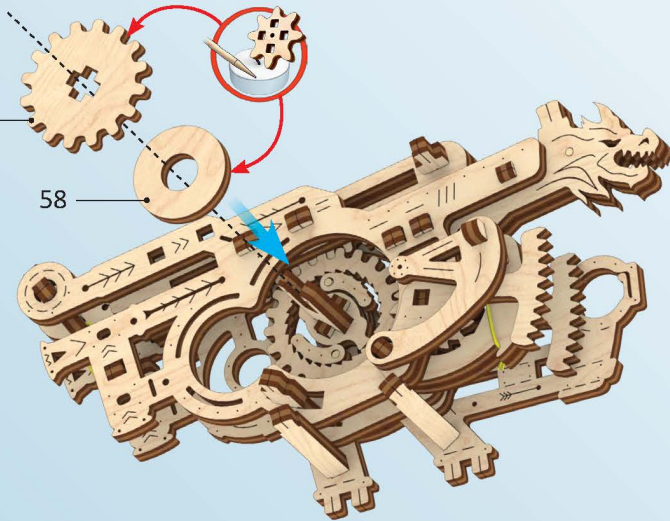

4

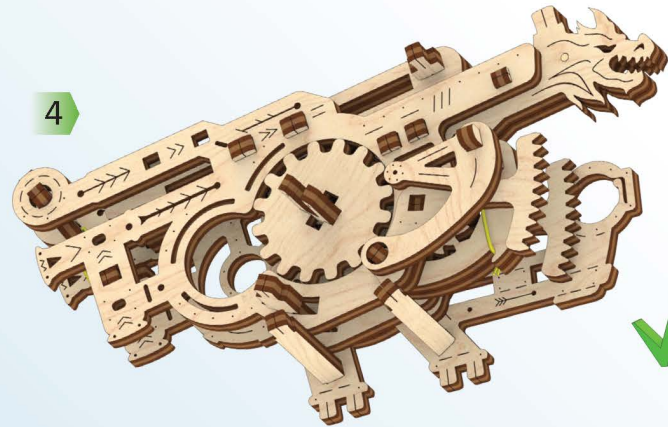

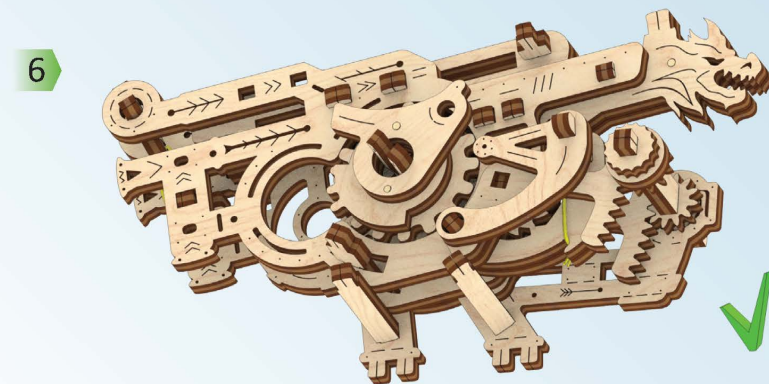
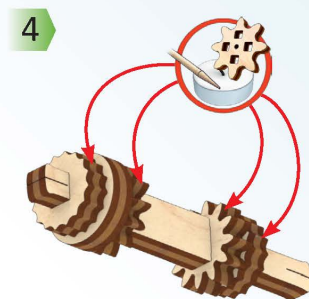
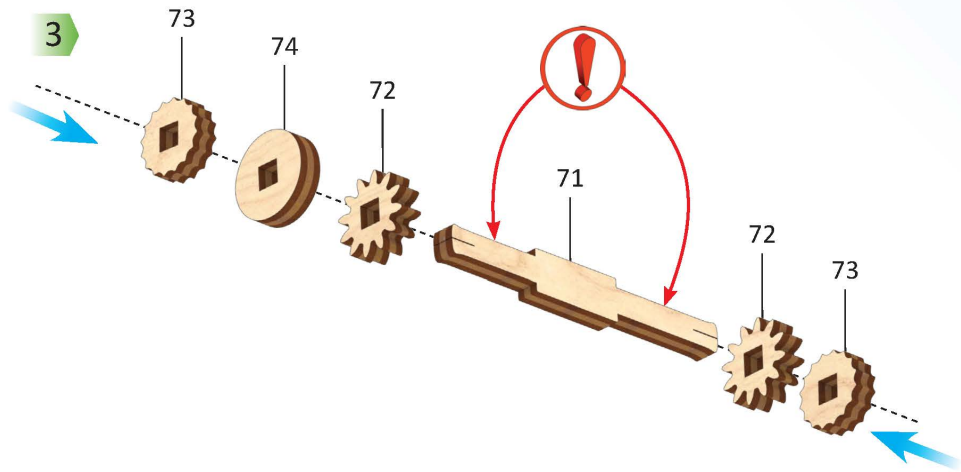
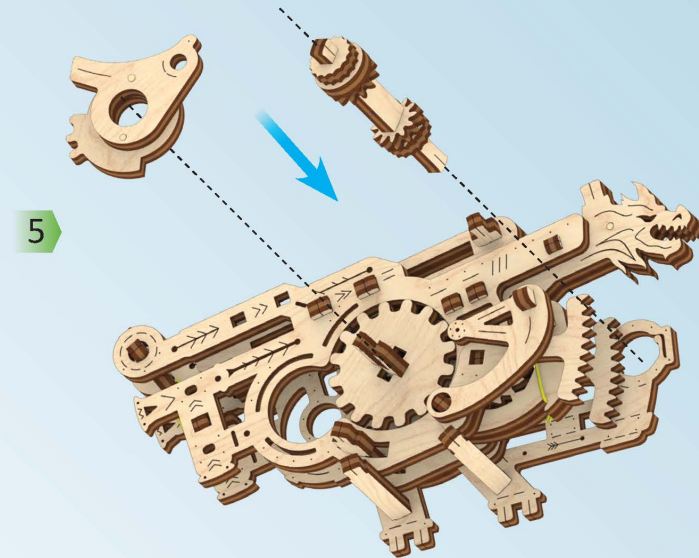
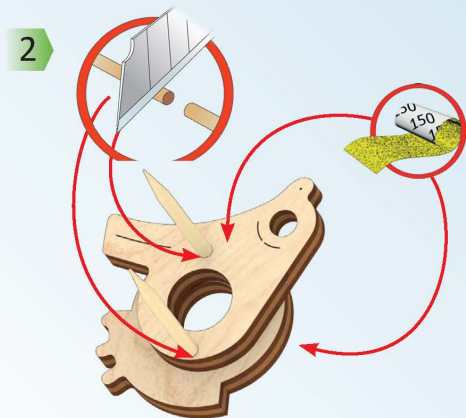
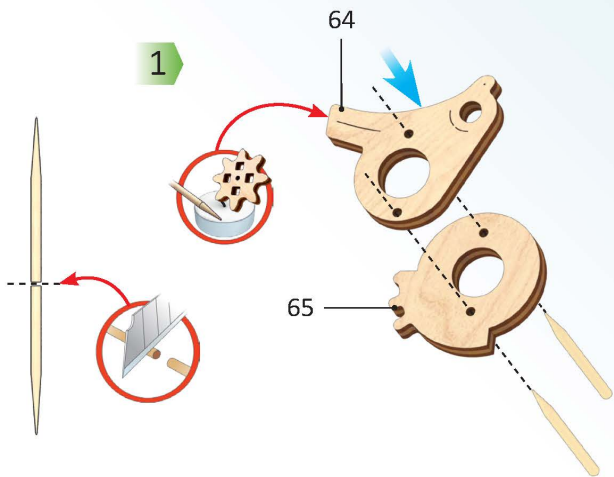
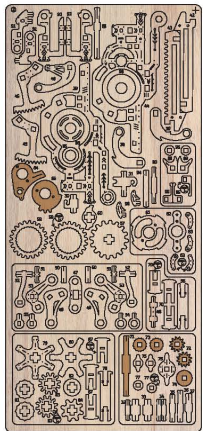

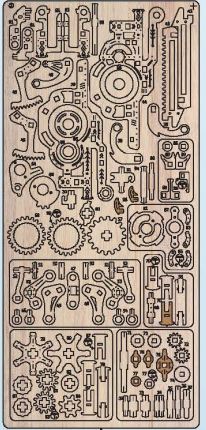

2

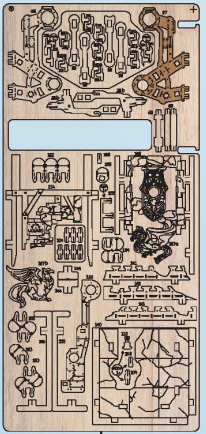

4

1

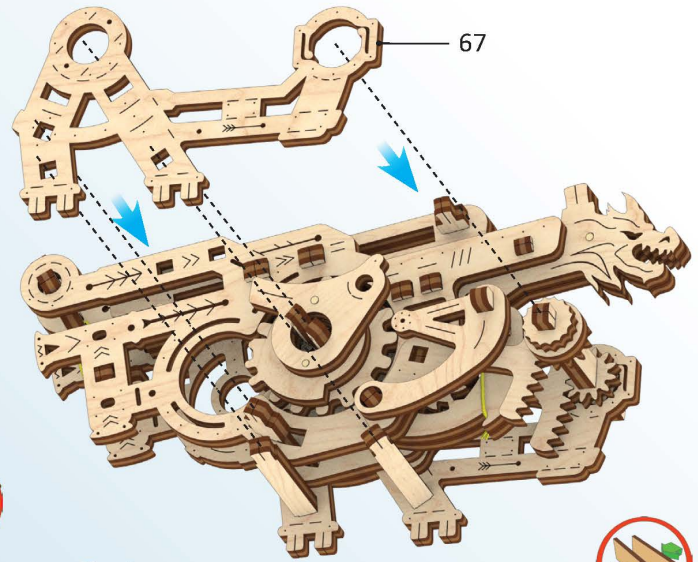

67

2

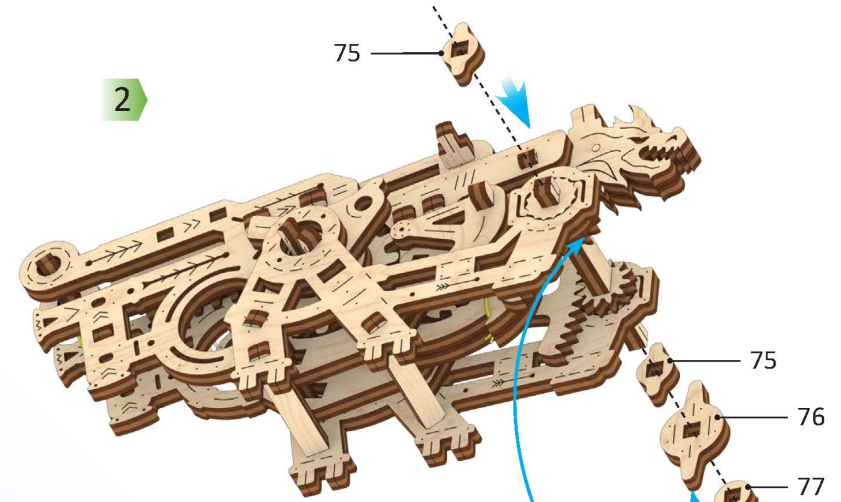

75

75

76

77

3

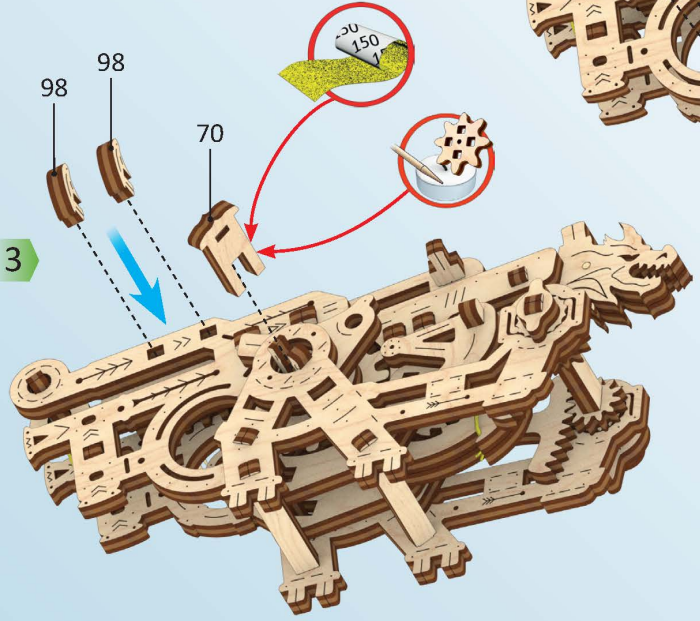

98

98

70

150

4

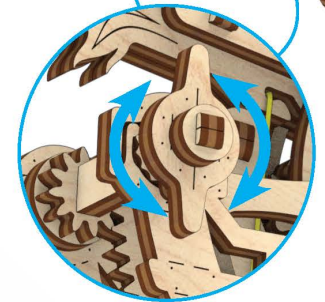
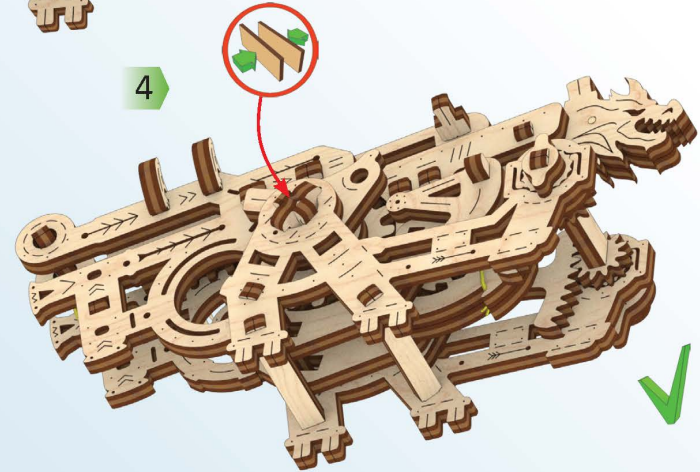

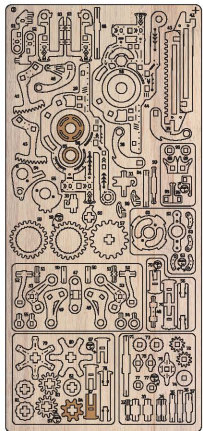

2

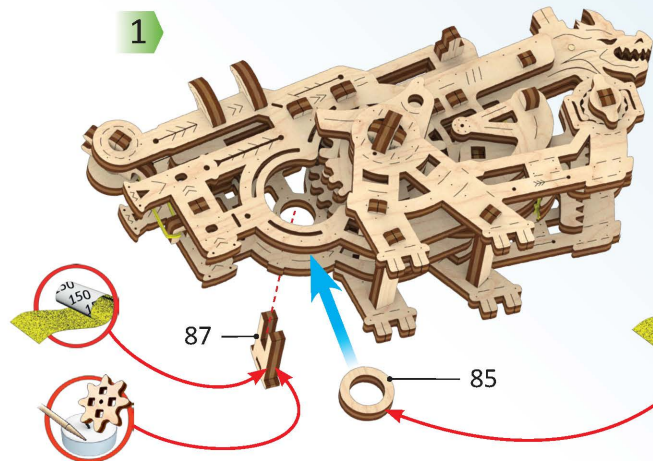

87

85

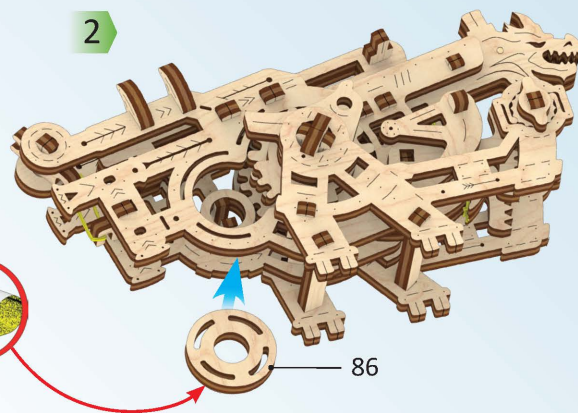

86

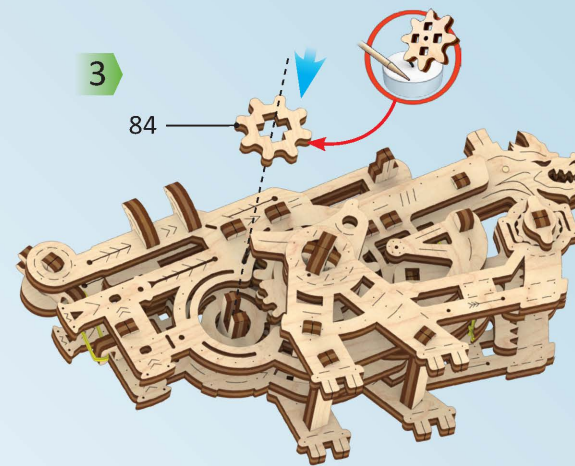

84

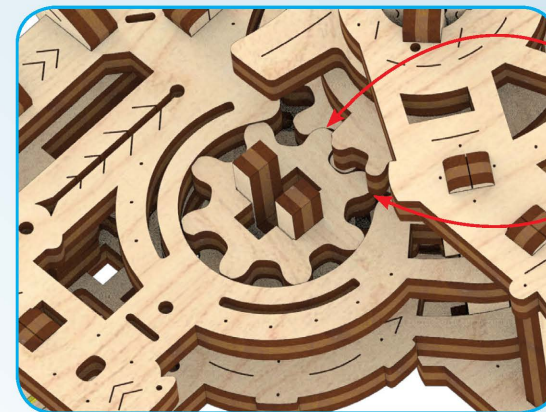
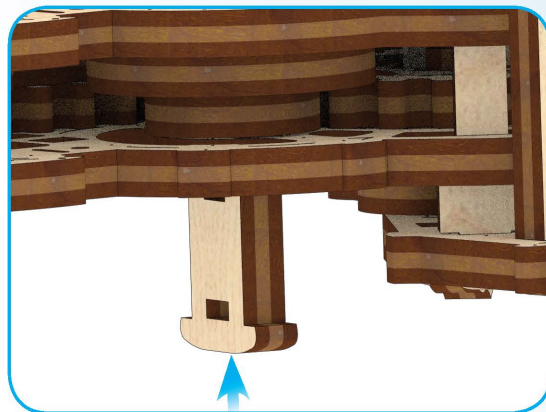
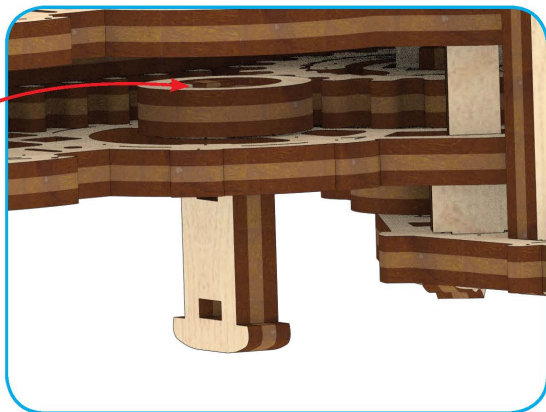

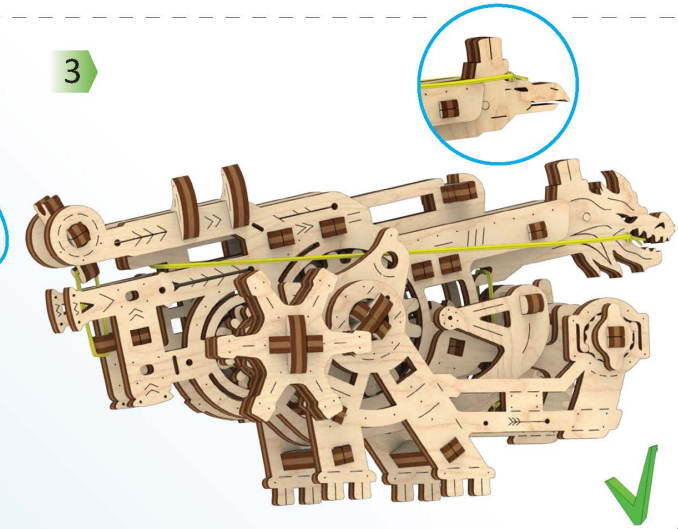
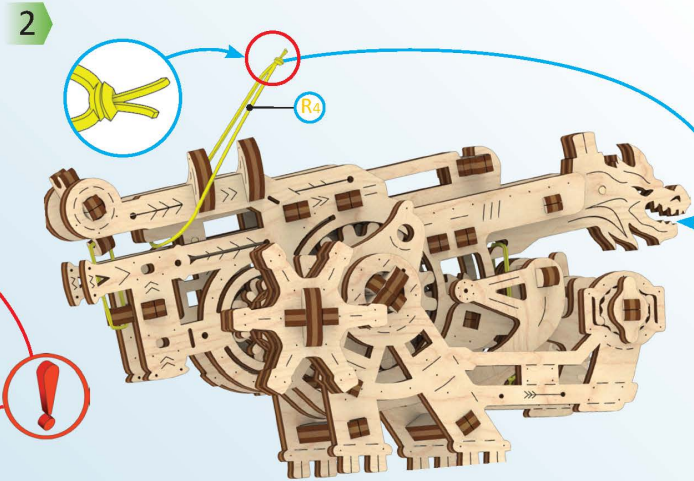
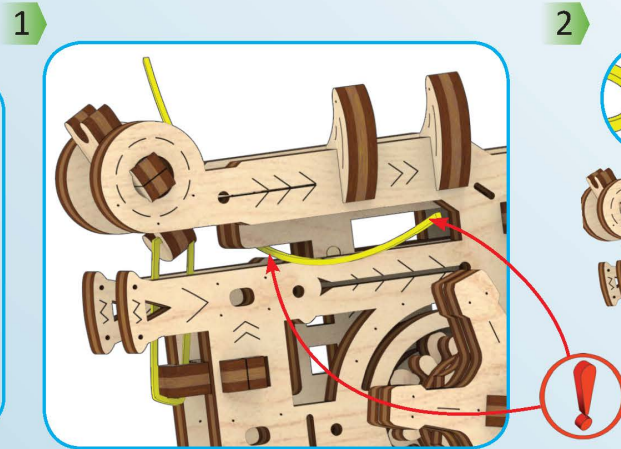
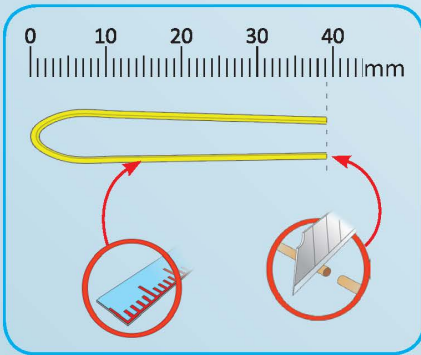
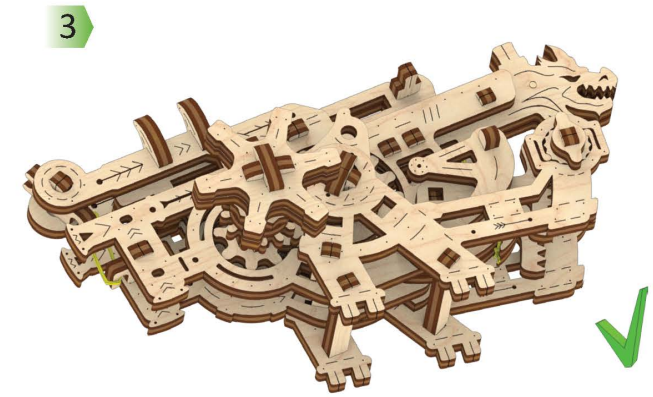
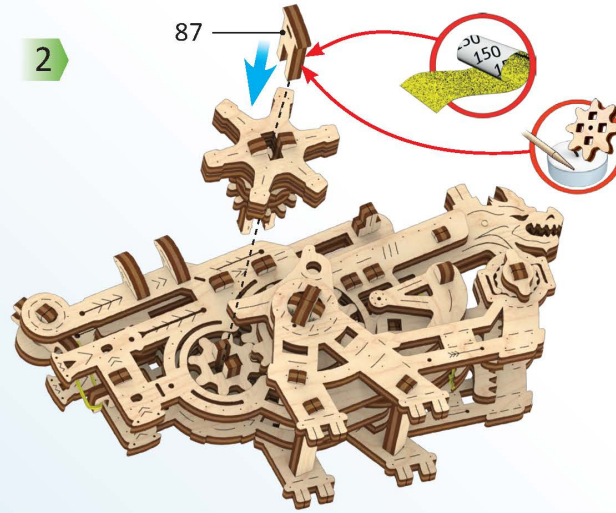
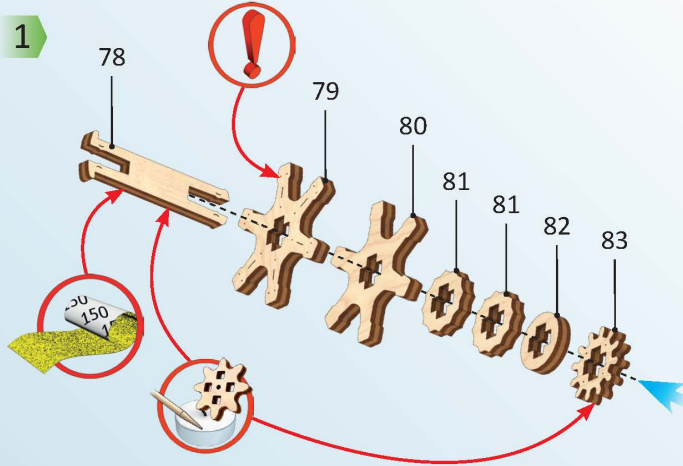
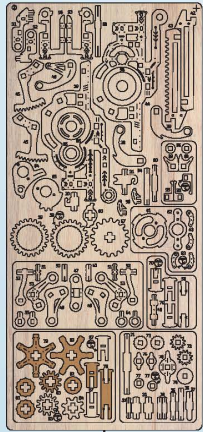

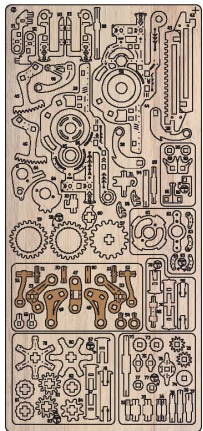

2

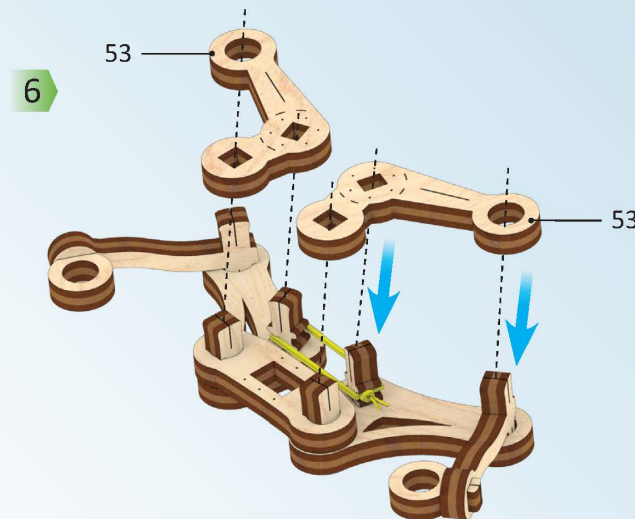
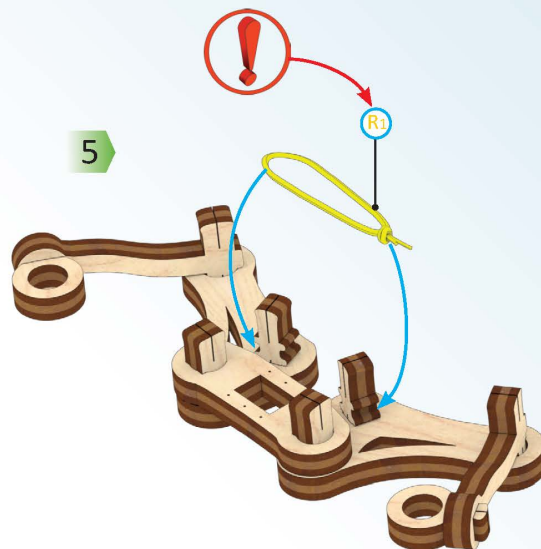
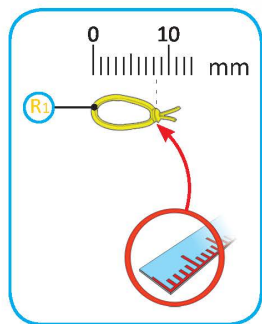
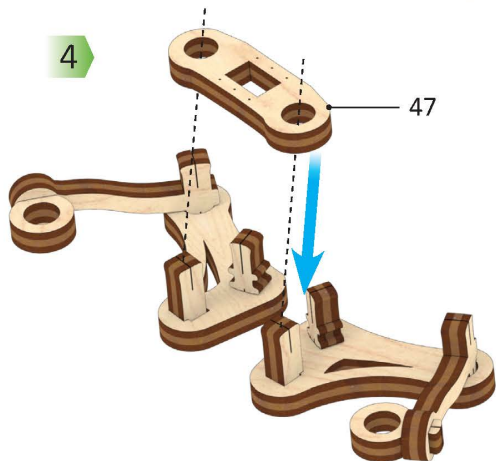
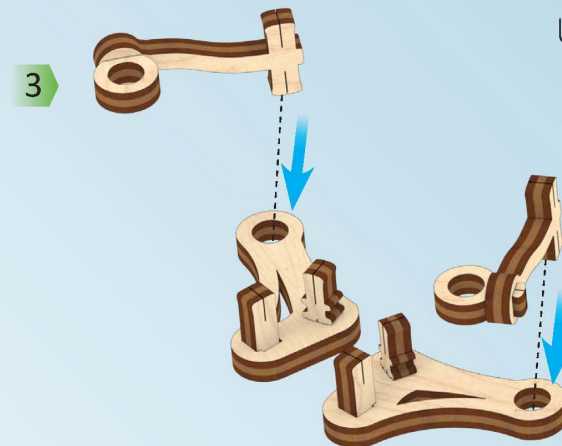
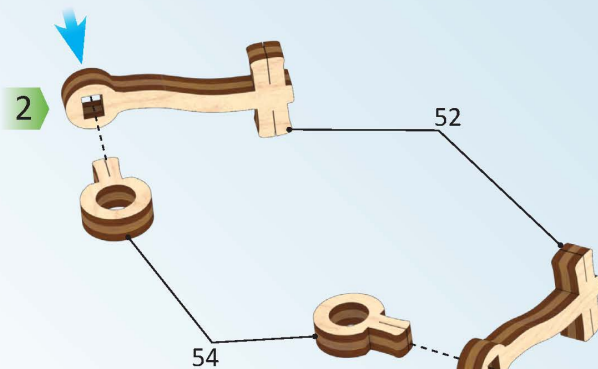
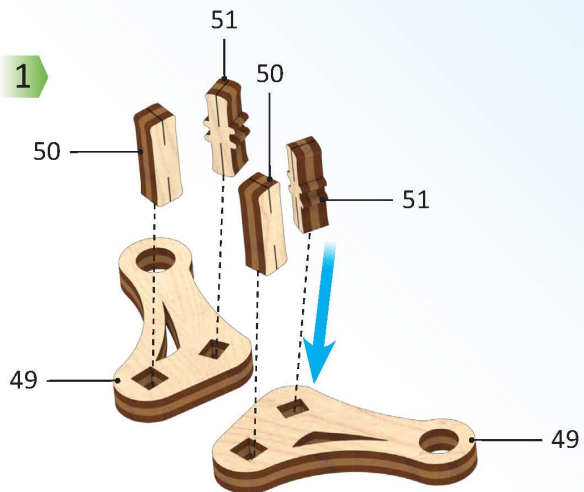

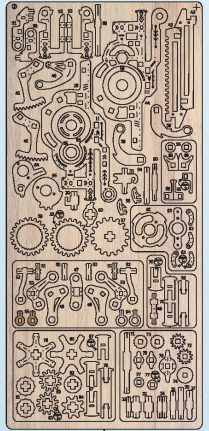

2

1

55

55

2

3

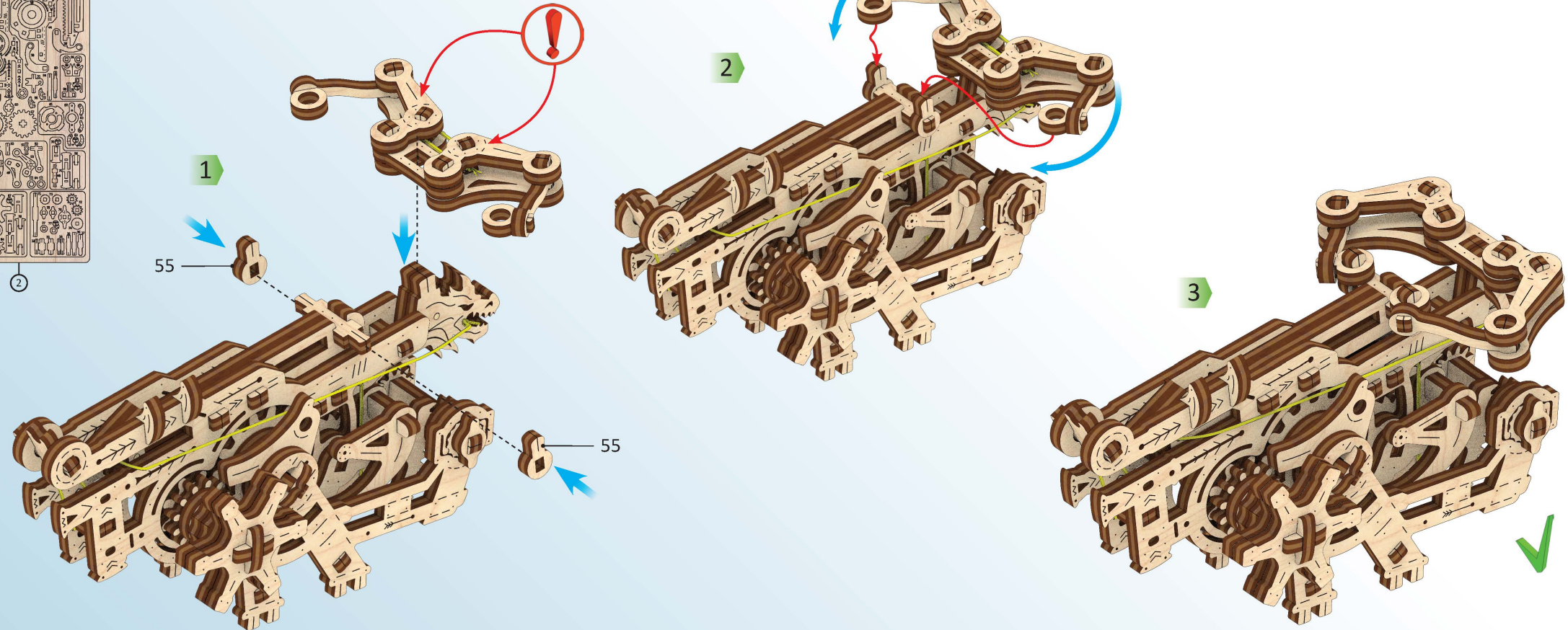

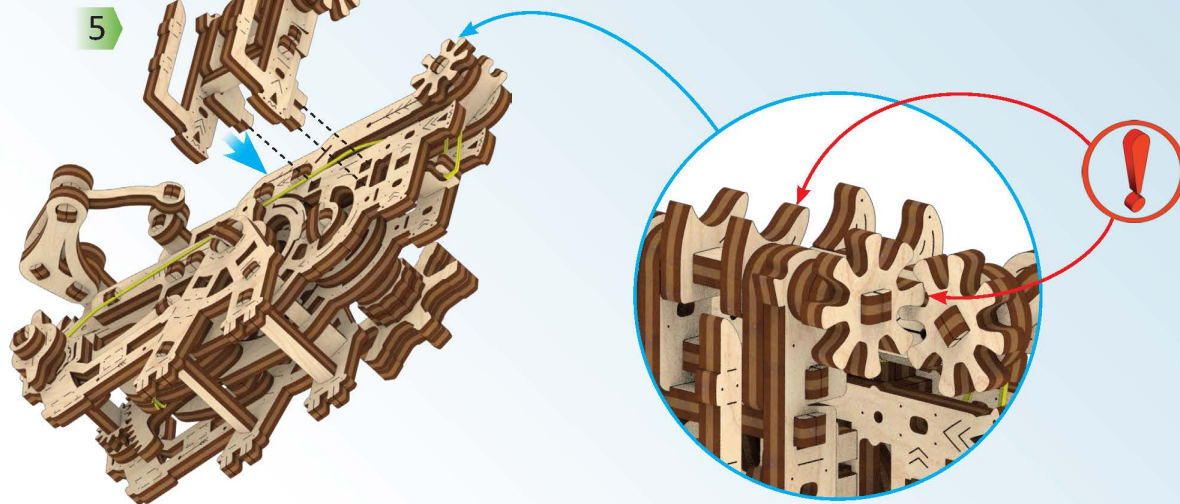
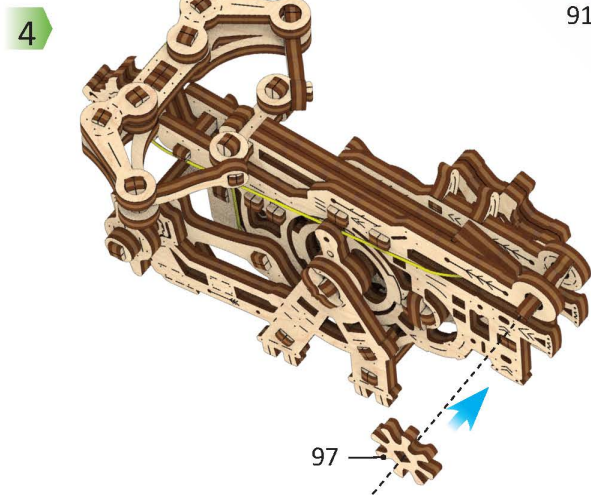
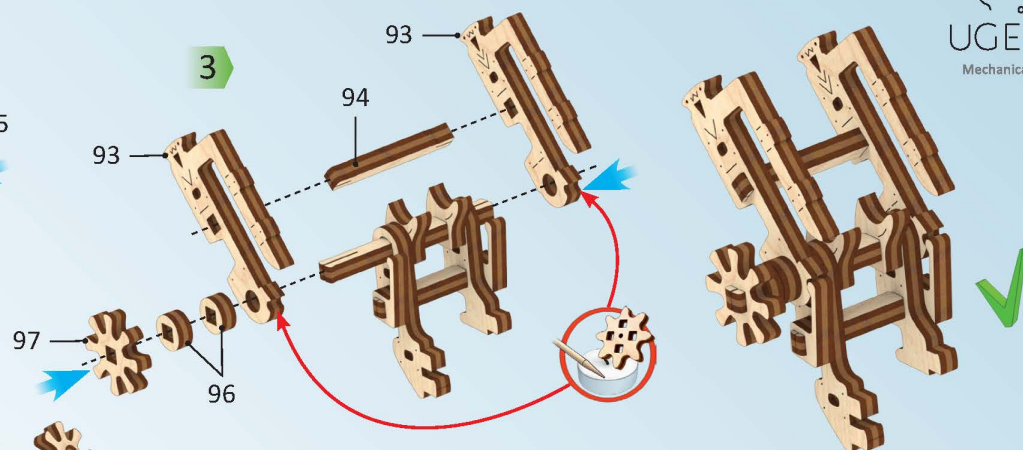
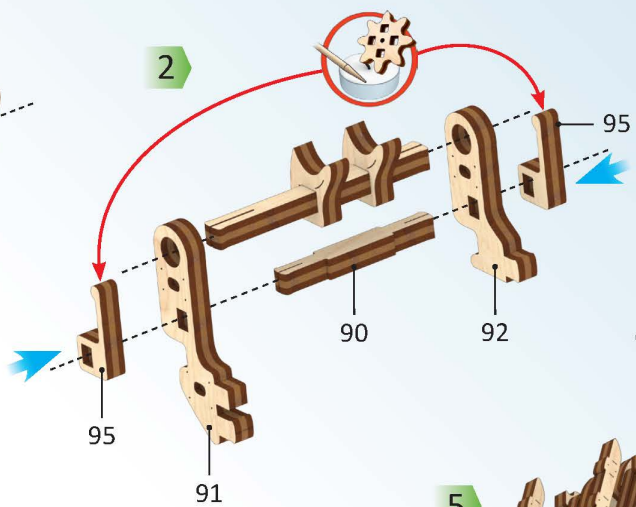
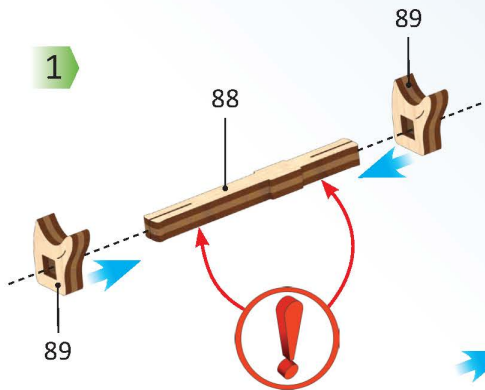
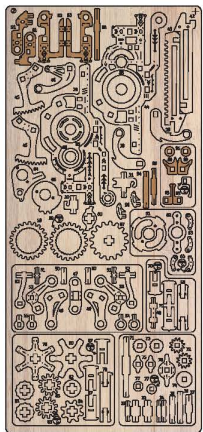
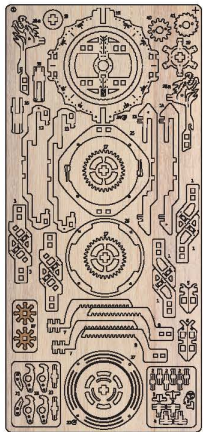

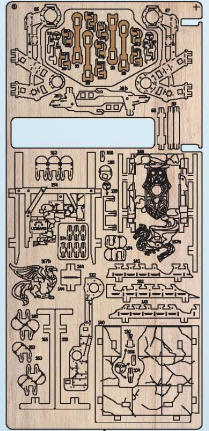

4

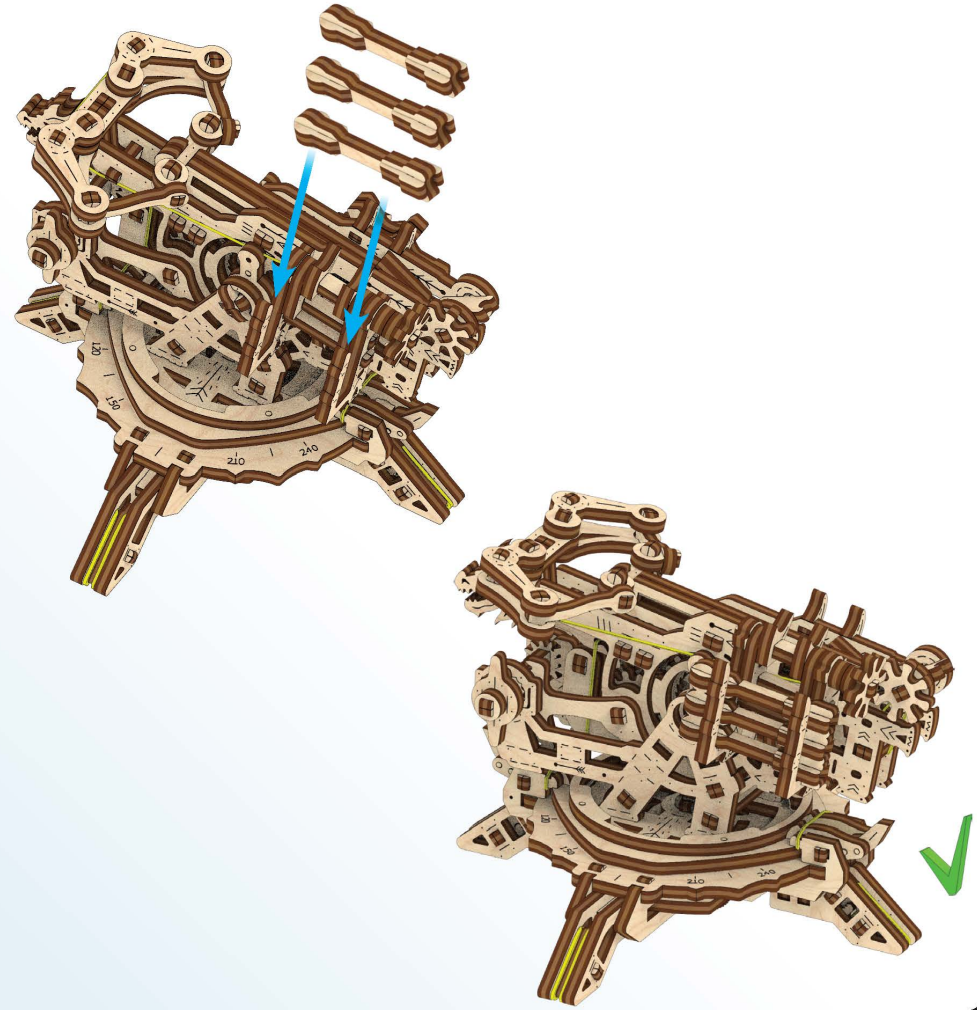
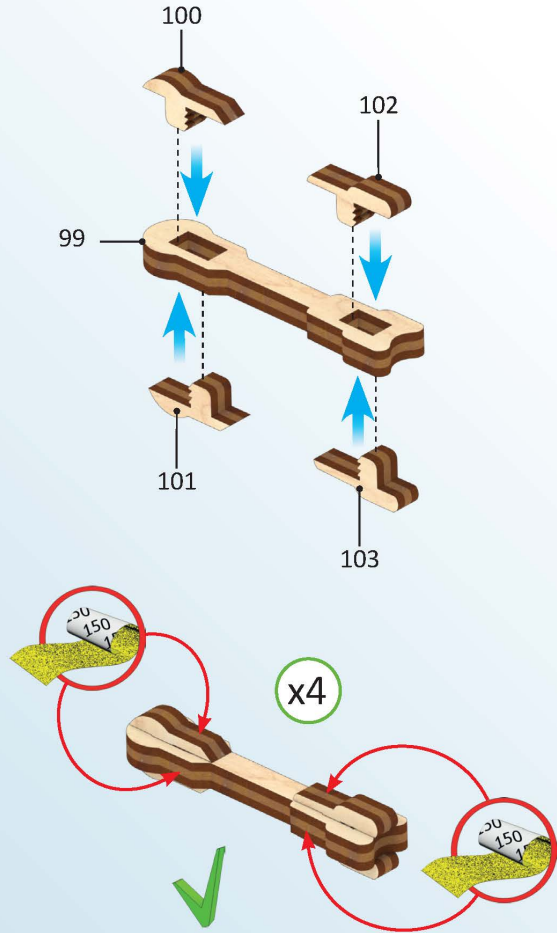
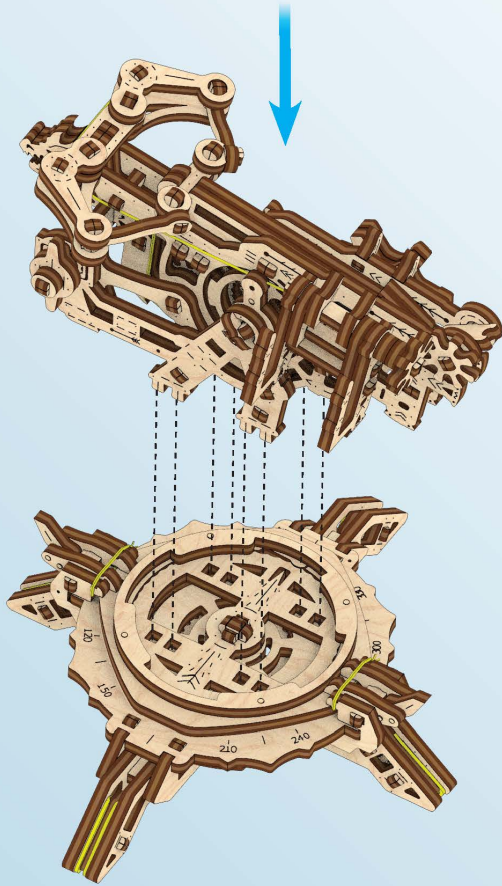

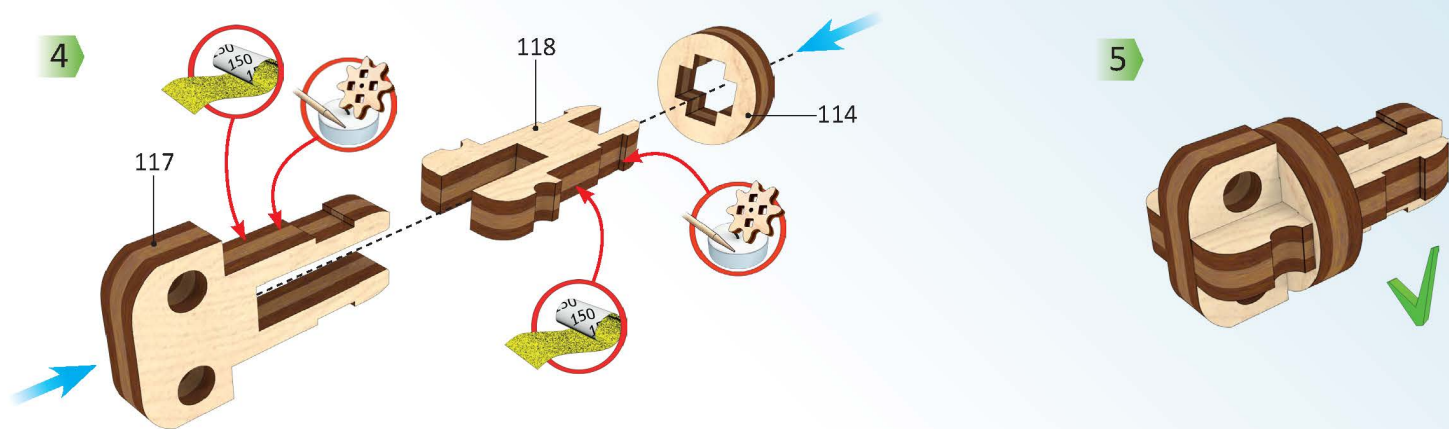
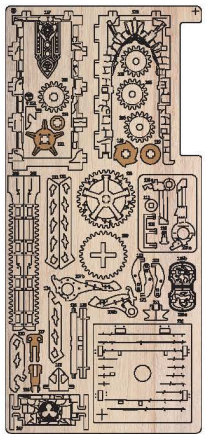
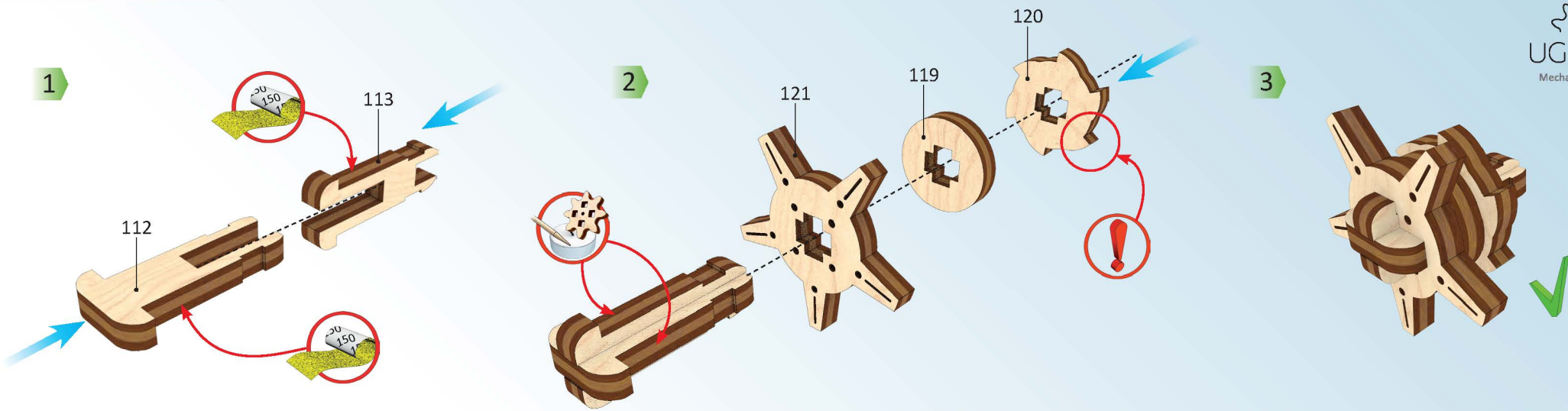
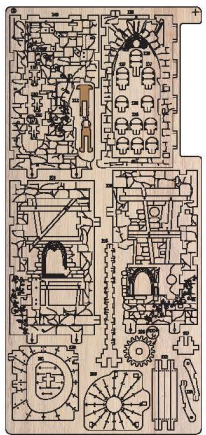

Mechanical models

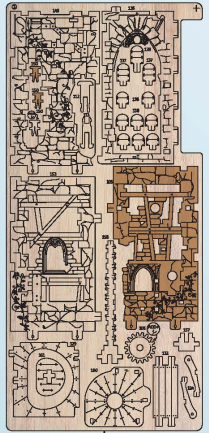

3

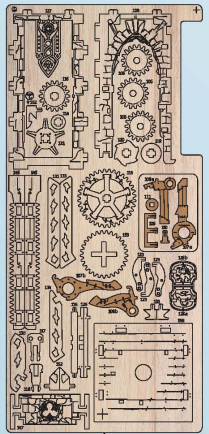

5

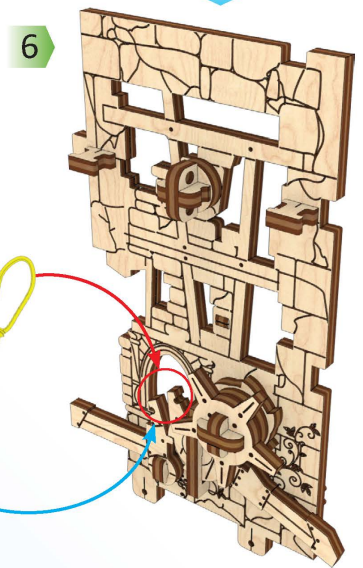
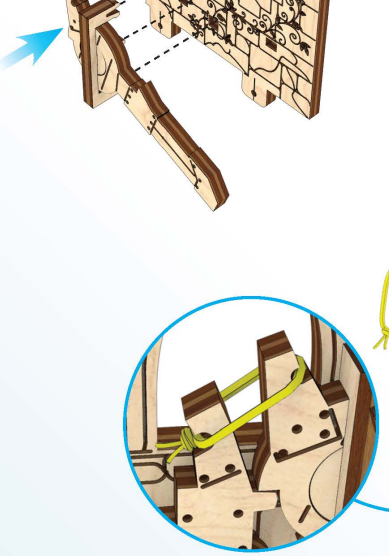
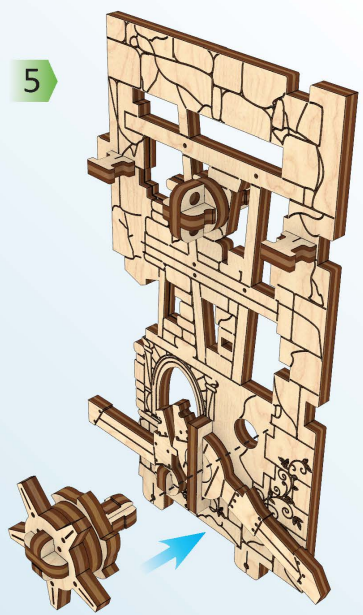
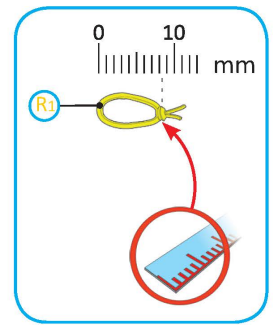
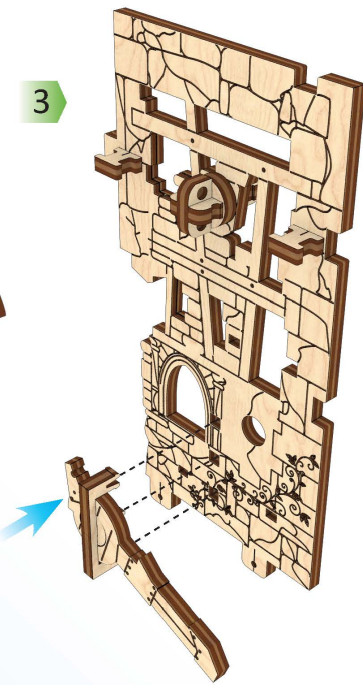
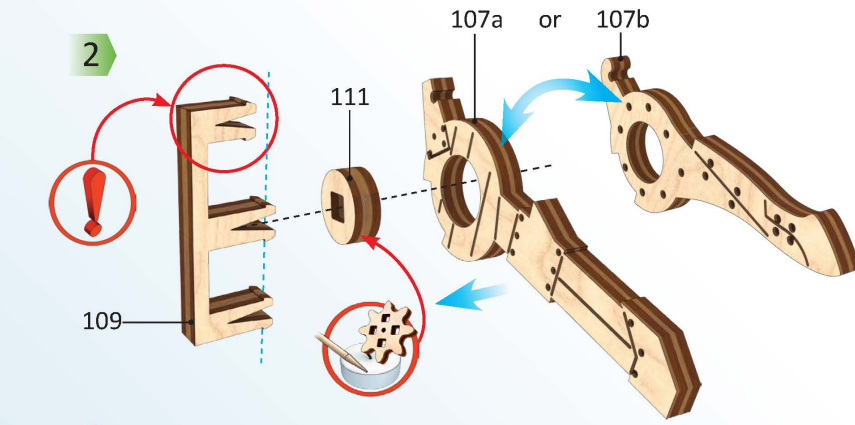
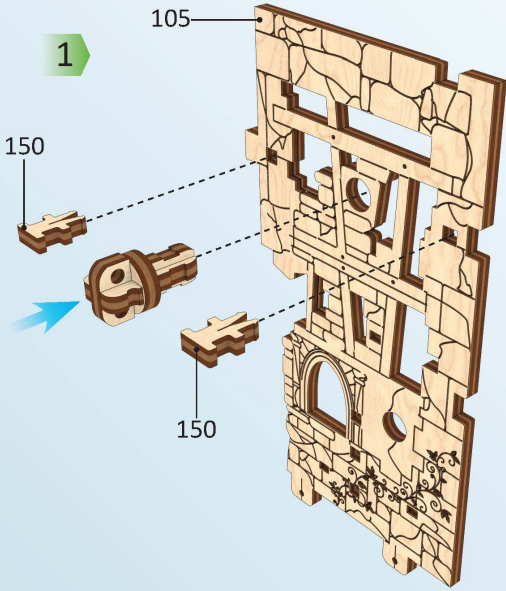

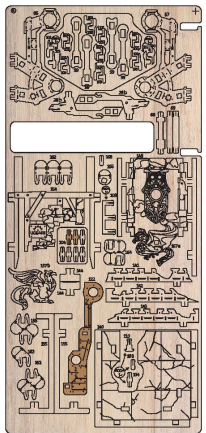

4

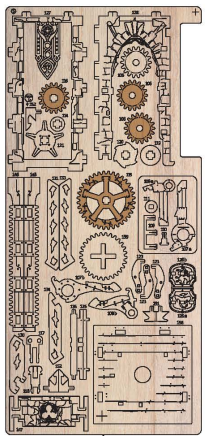

5

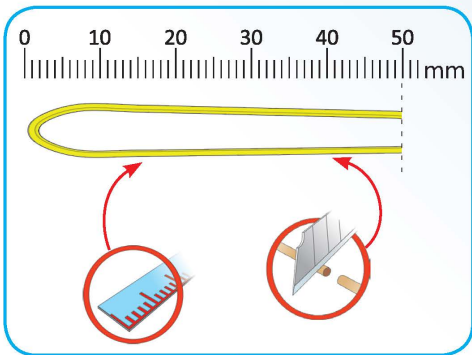

1

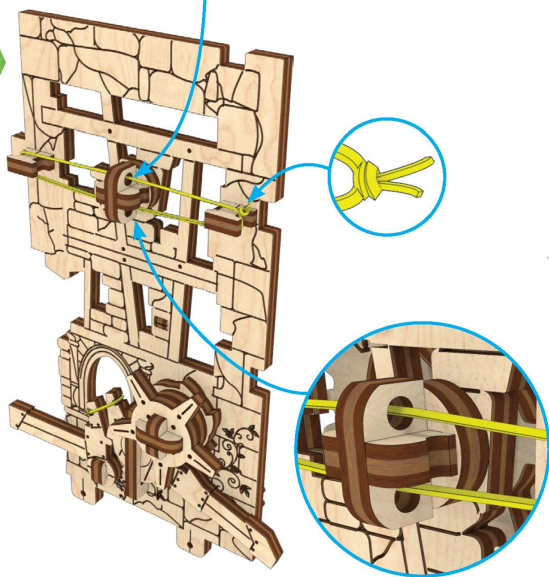

2

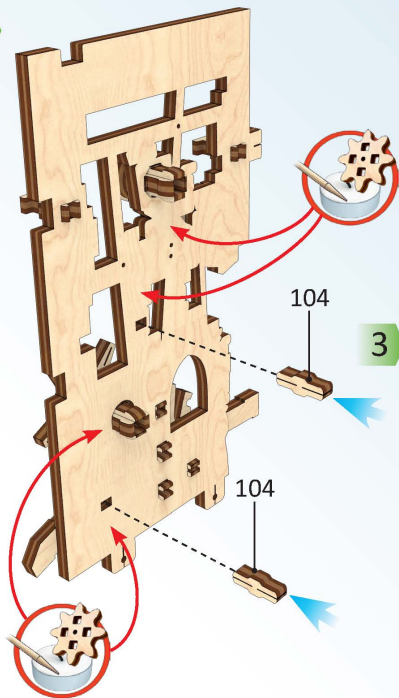

3

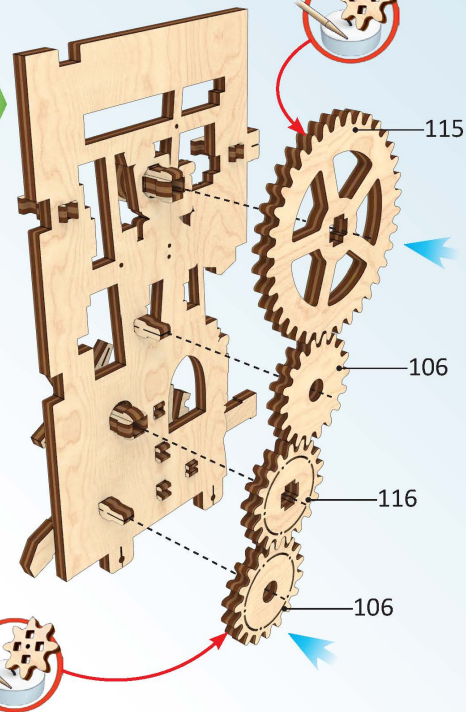

4

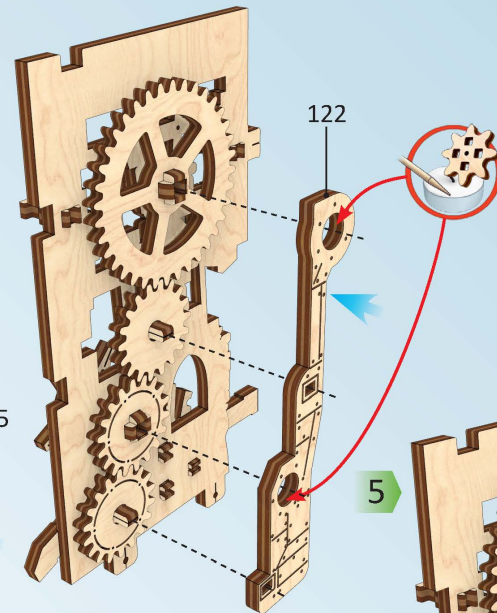

5

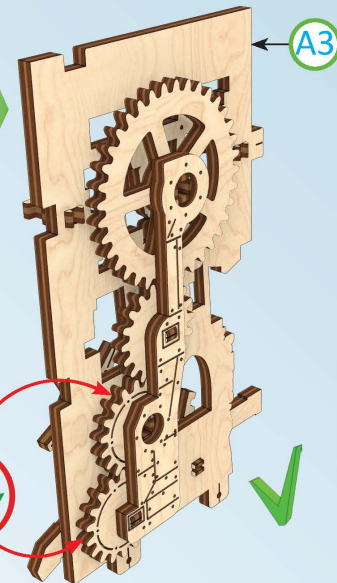

Mechanical models

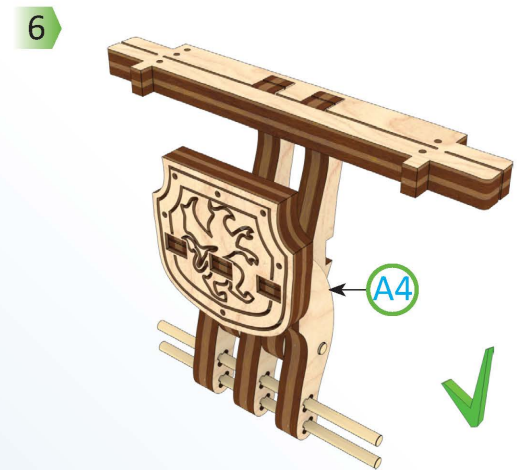
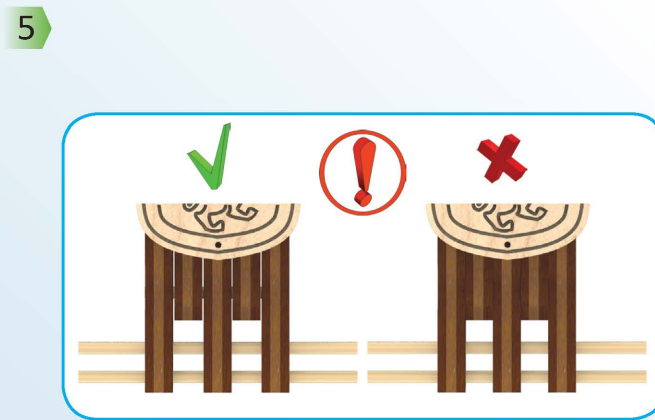
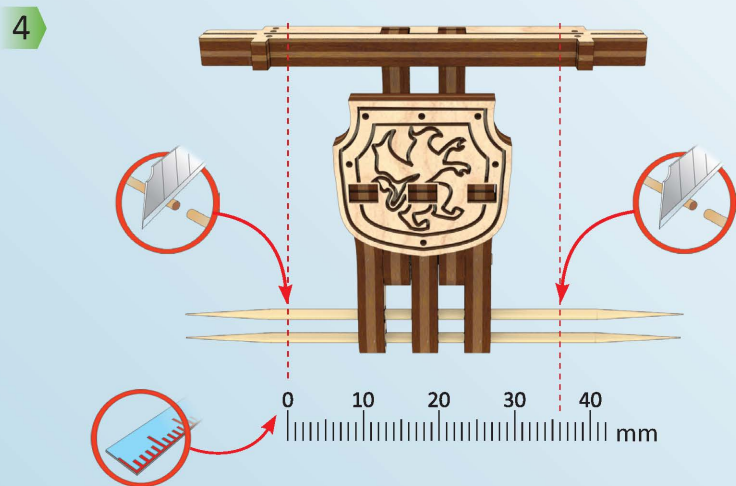
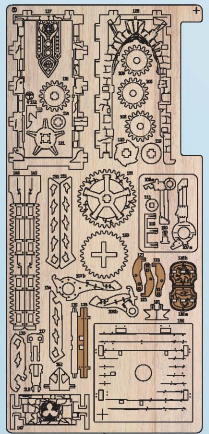
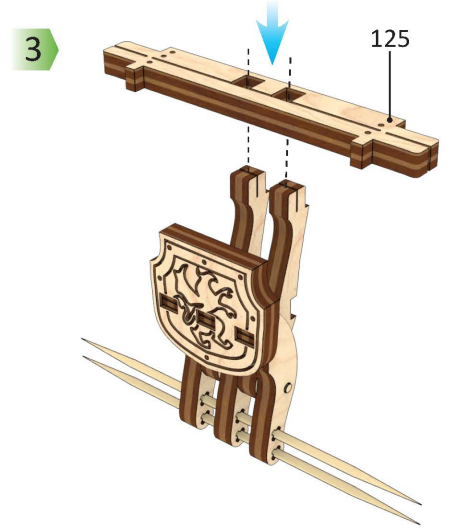
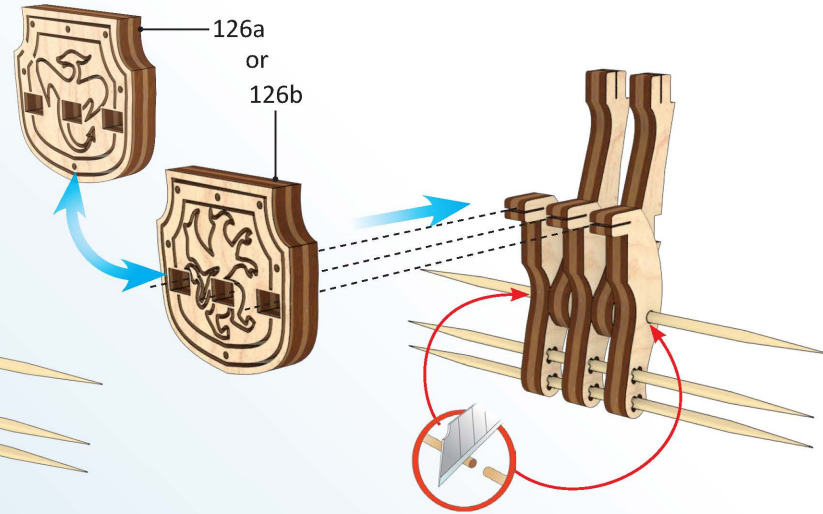
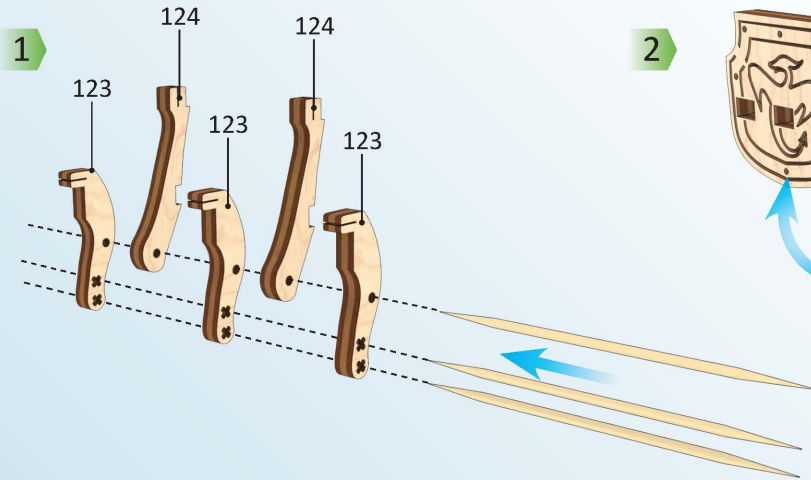
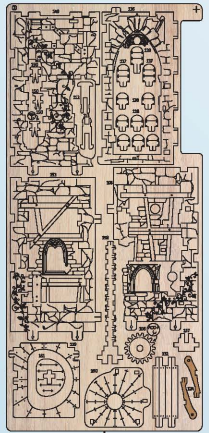

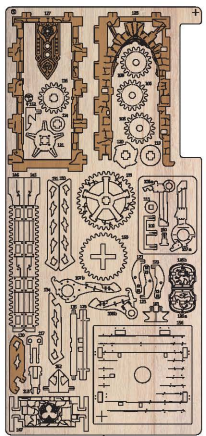
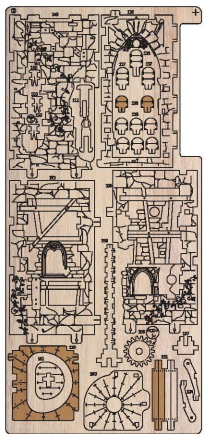

1

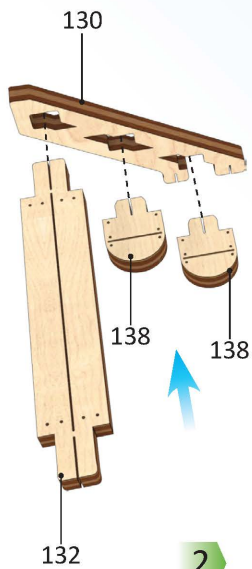

2

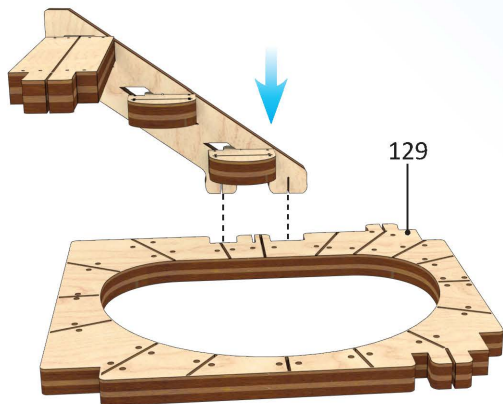

3

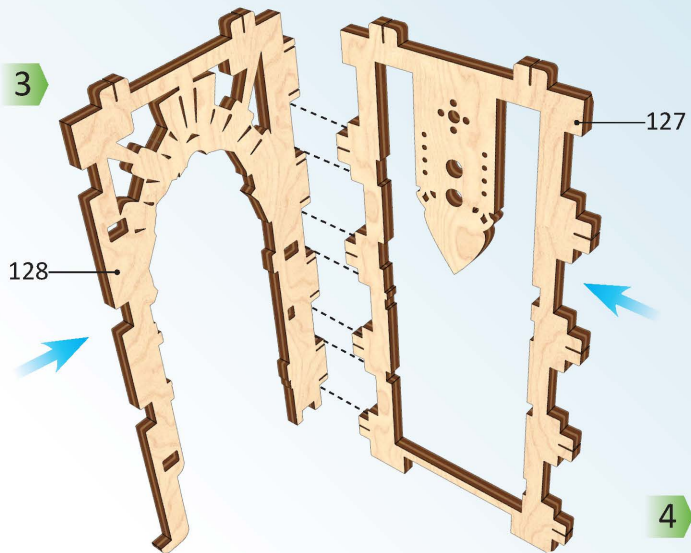

4

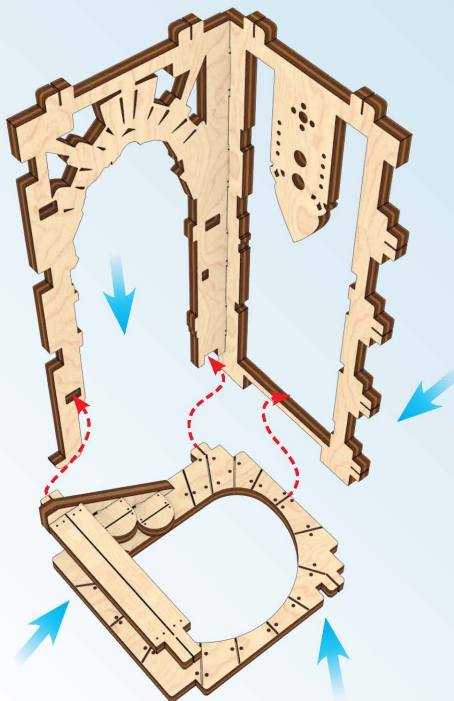

5

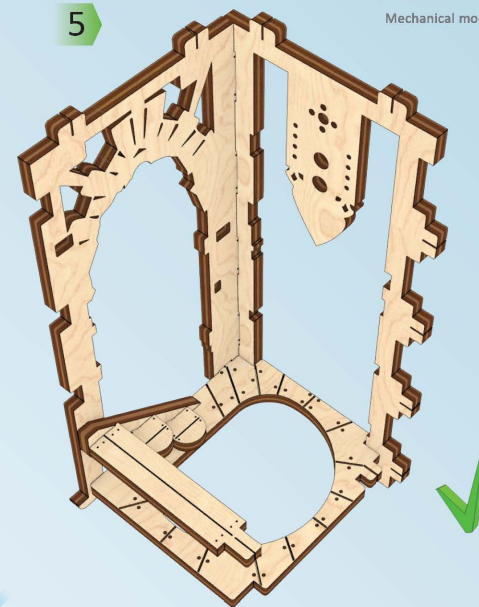

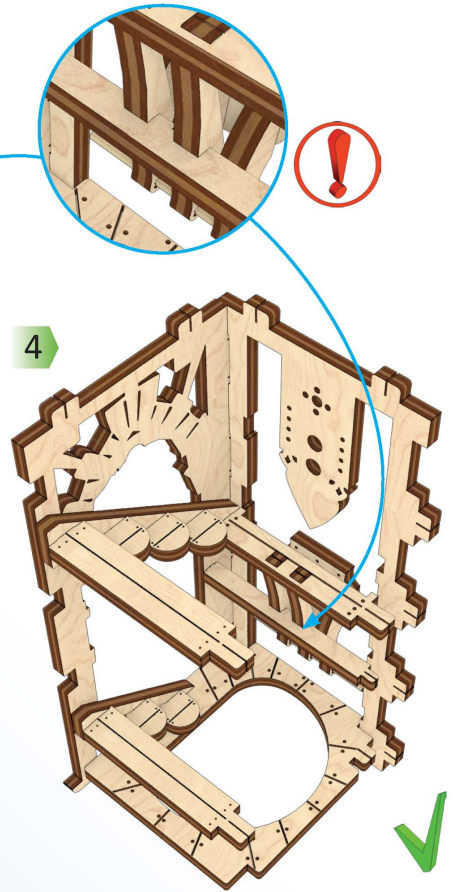
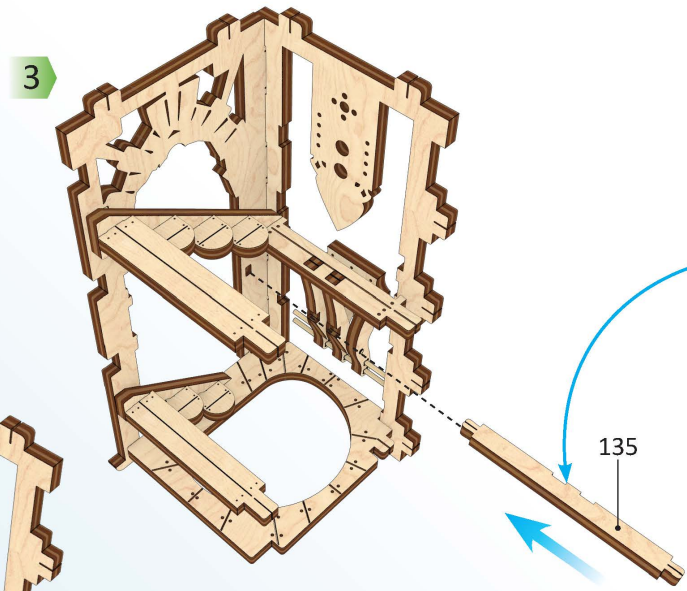
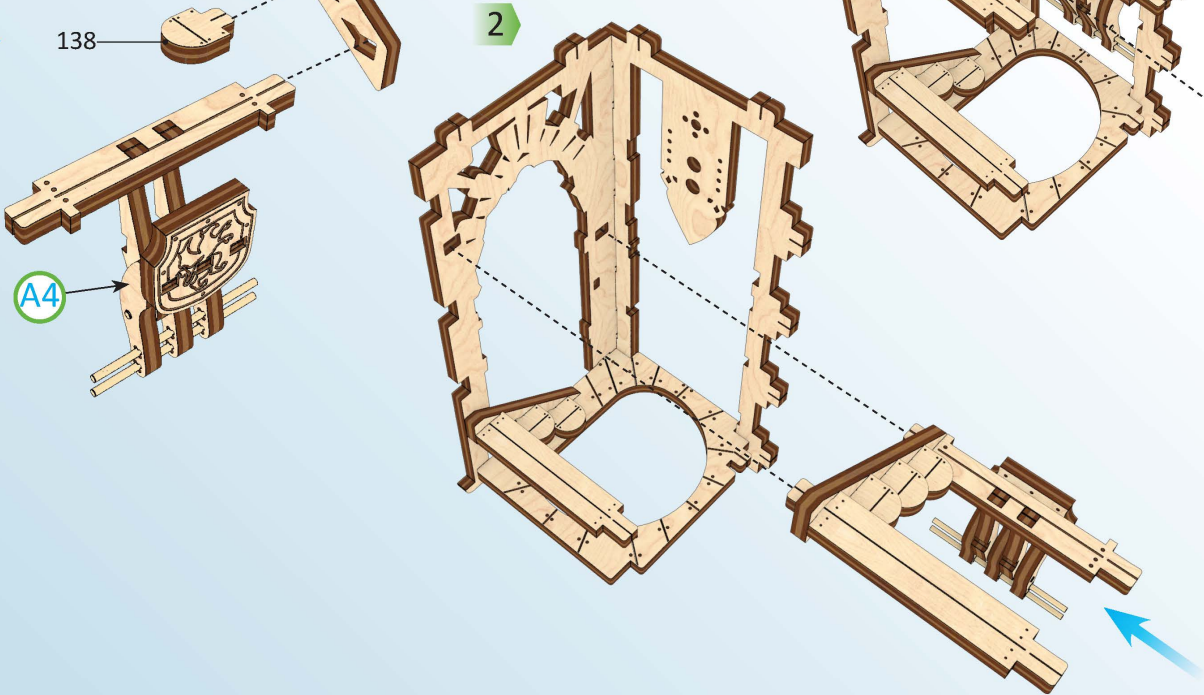
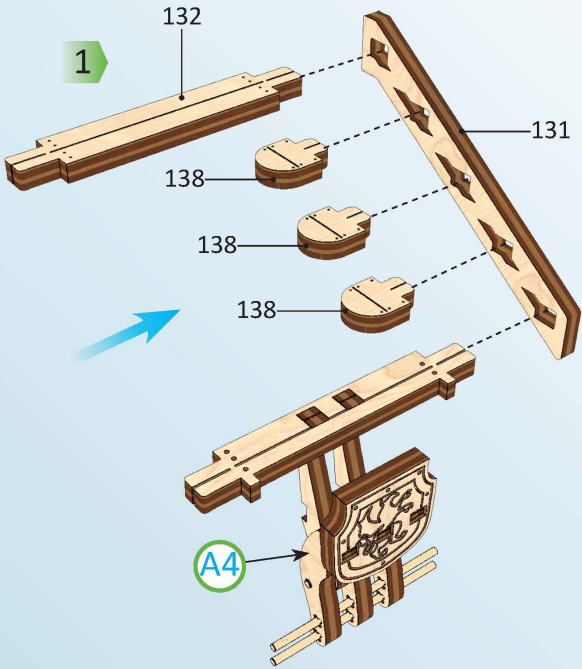
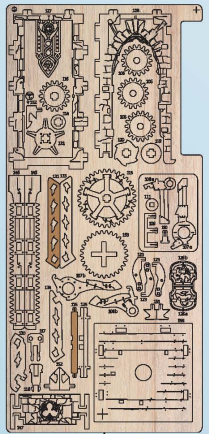
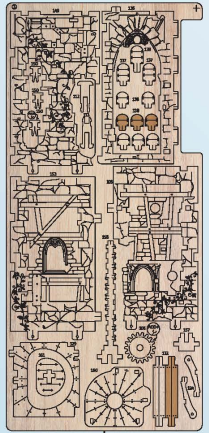

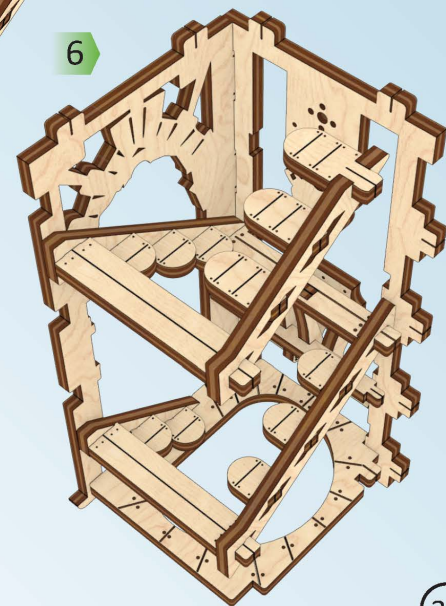
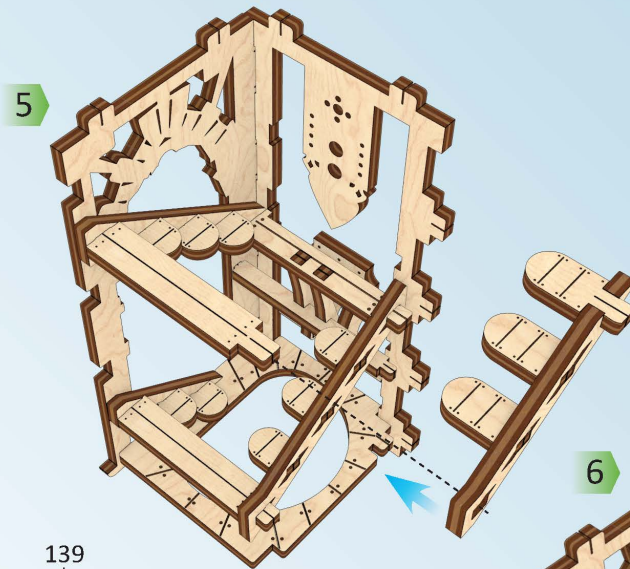
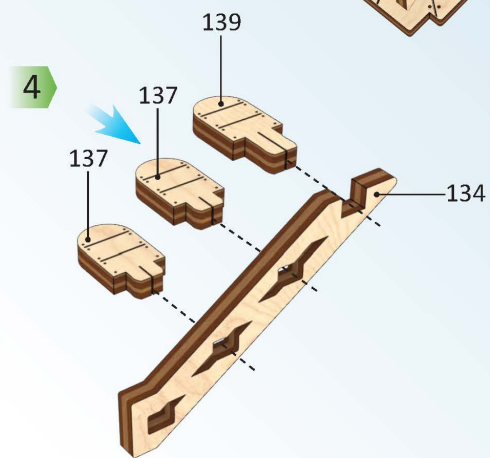
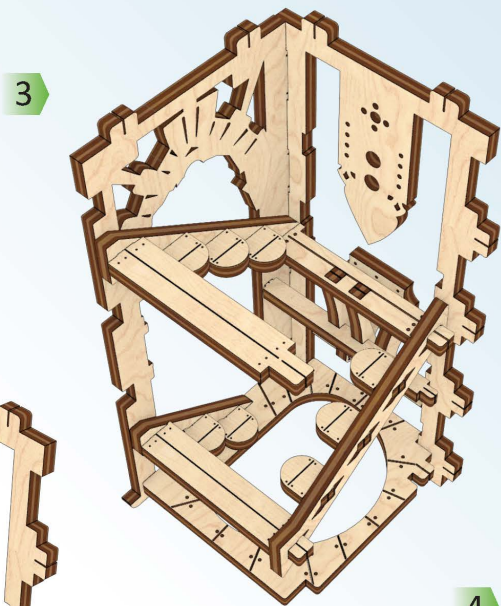
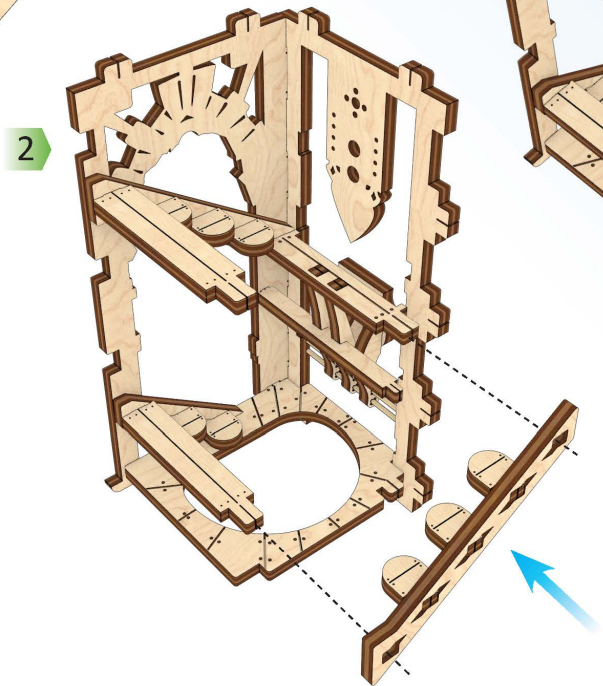
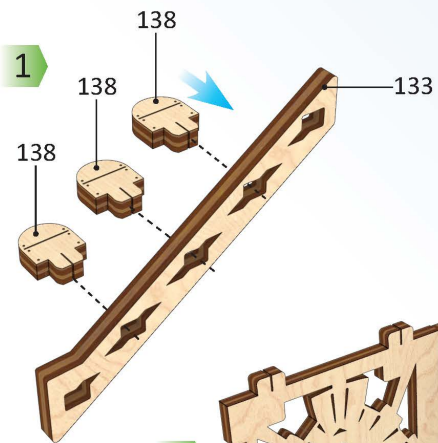
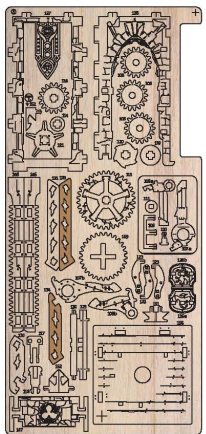
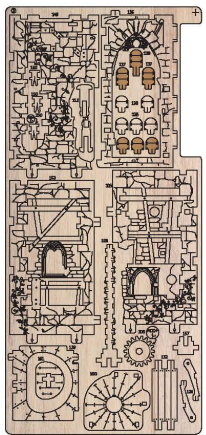

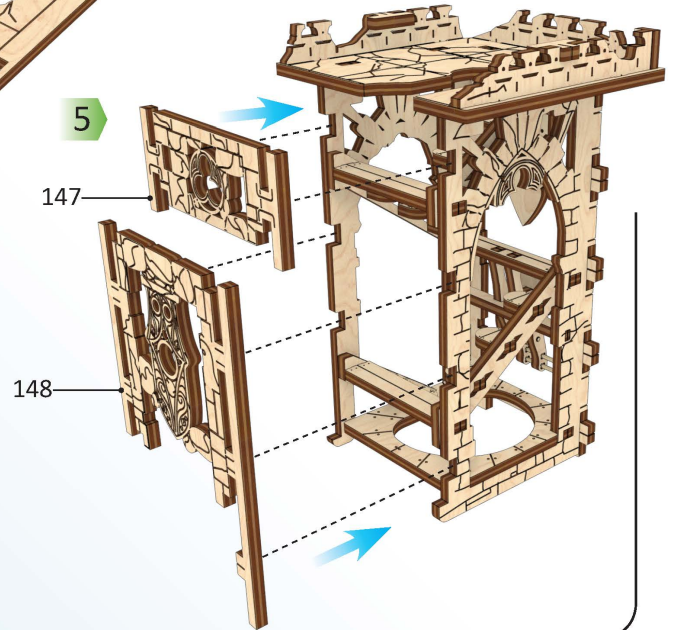
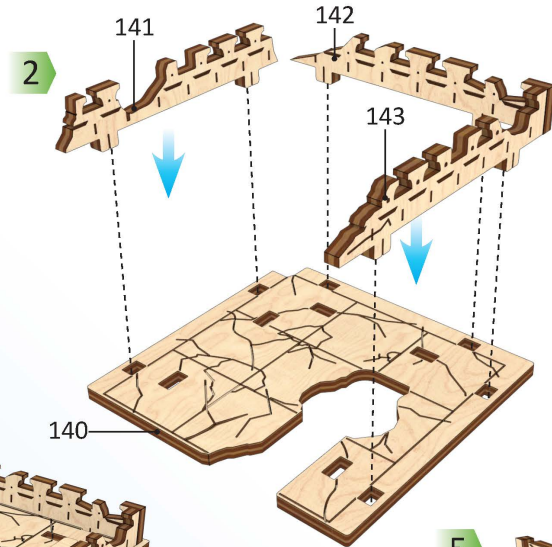
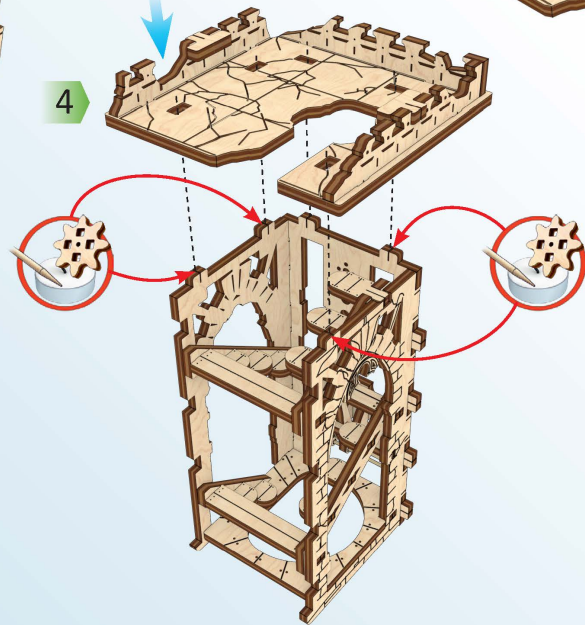
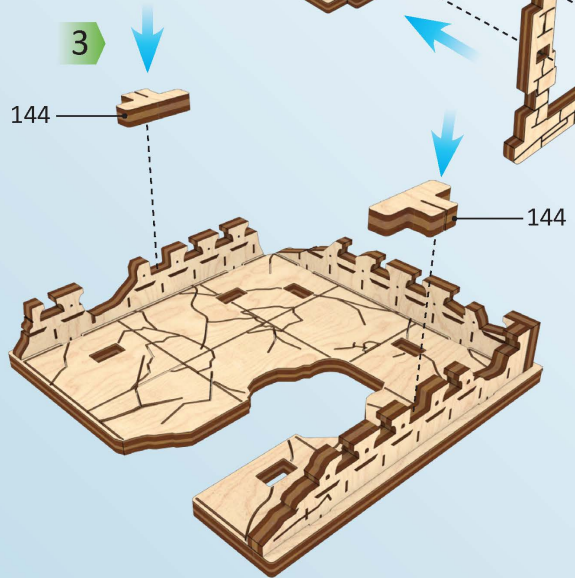
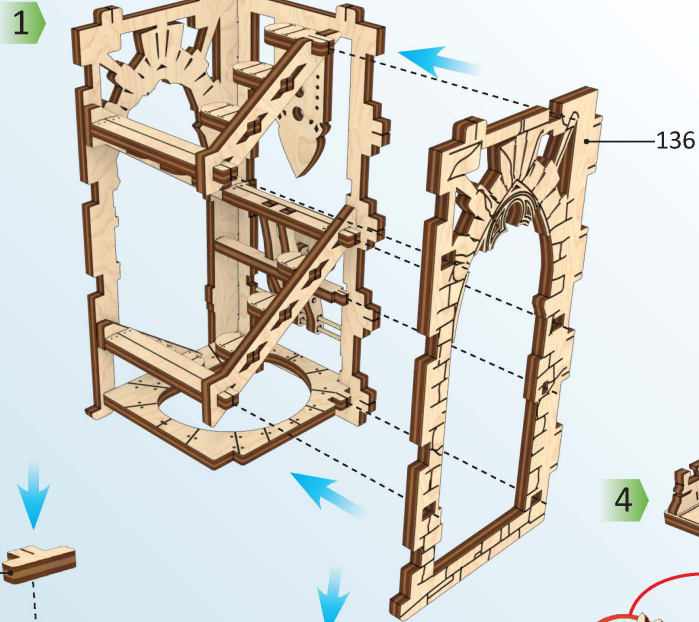
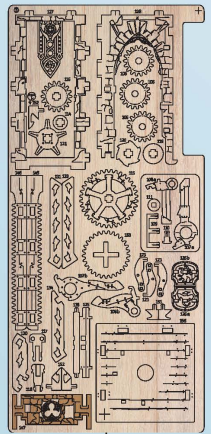
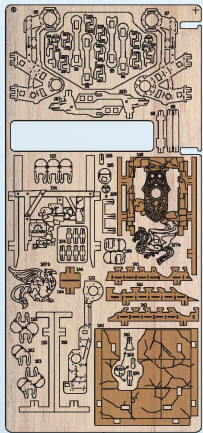
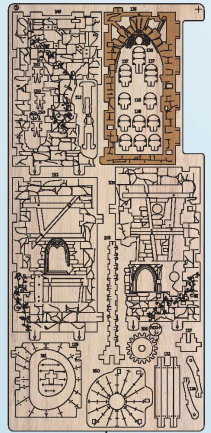

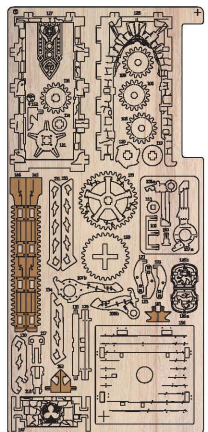
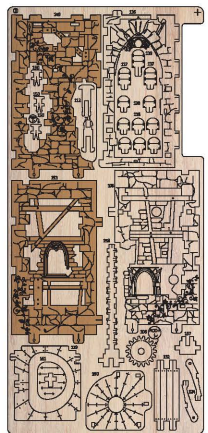

1

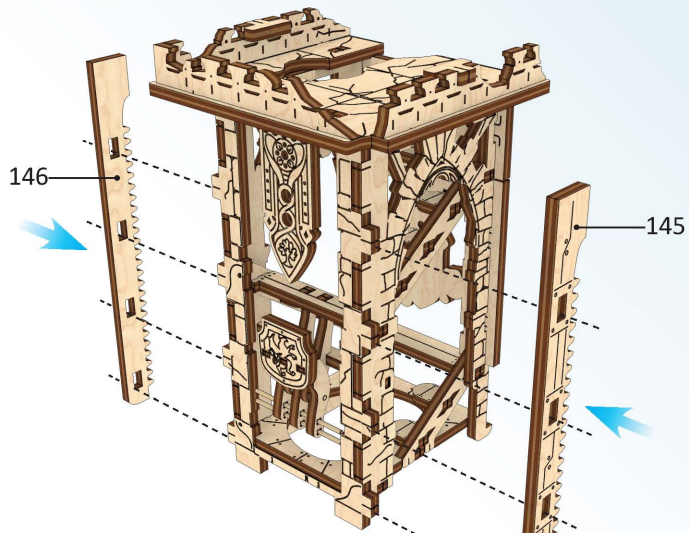

2

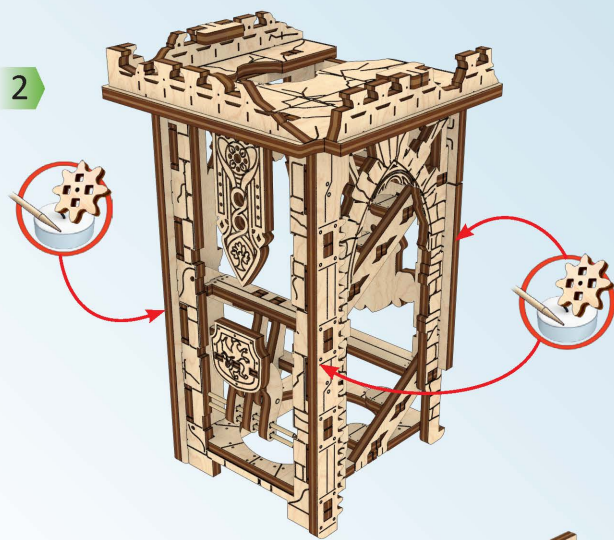

3

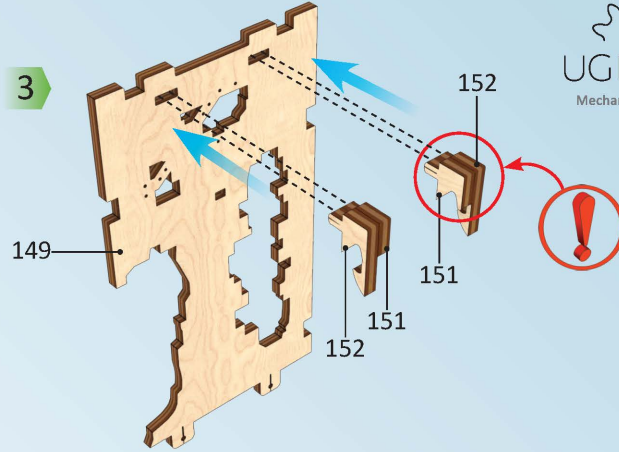

4

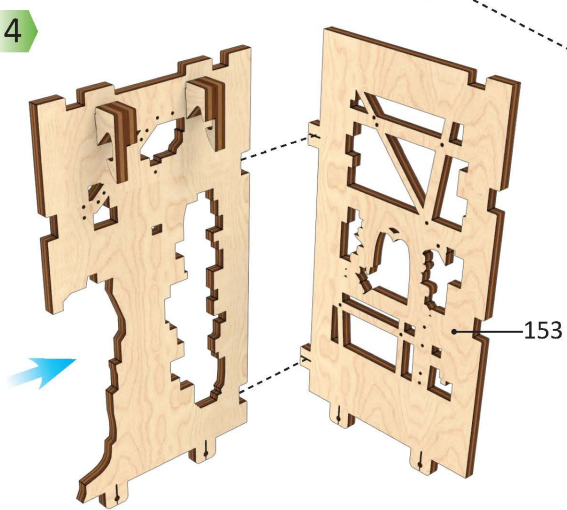

5

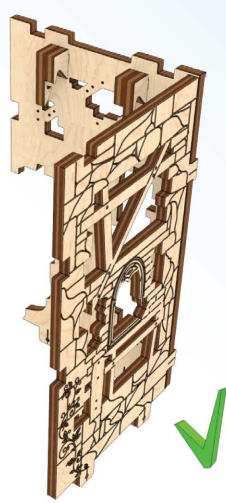

6

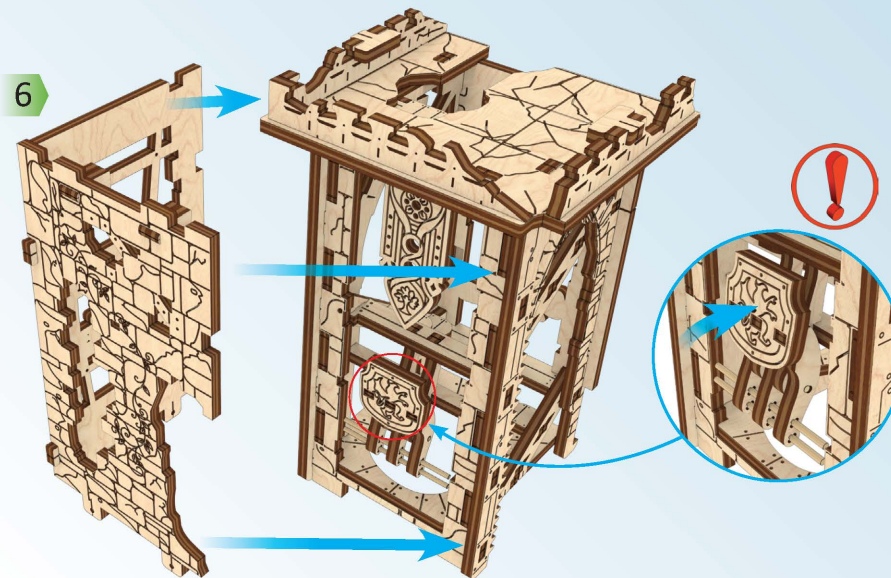

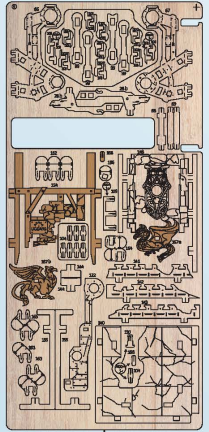

1

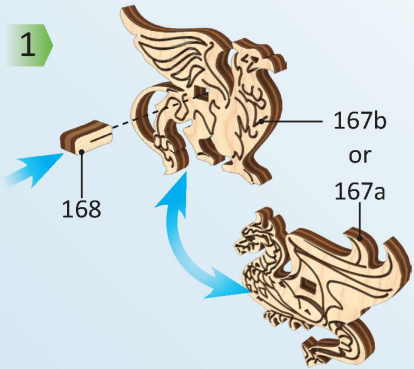

2

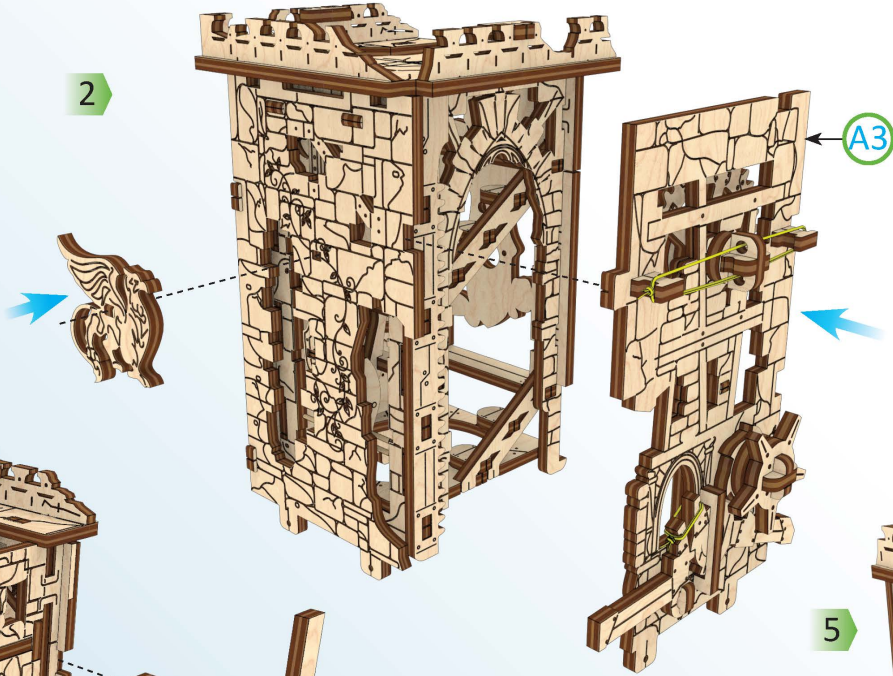

3

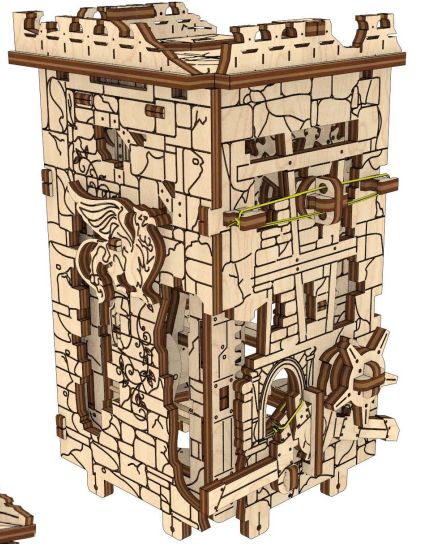

4

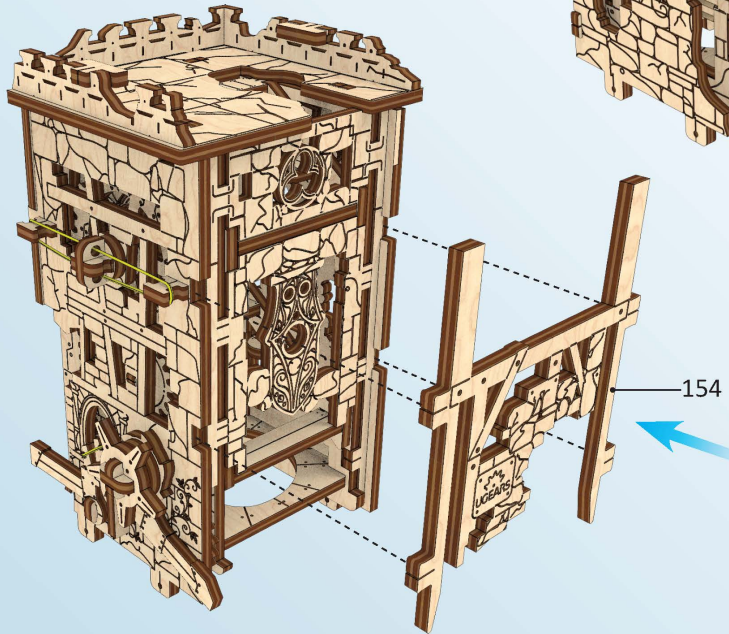

5

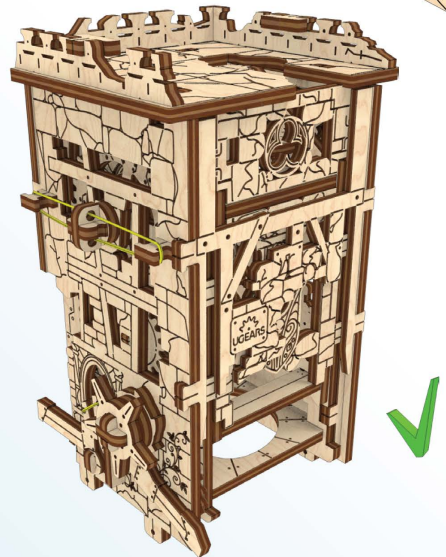

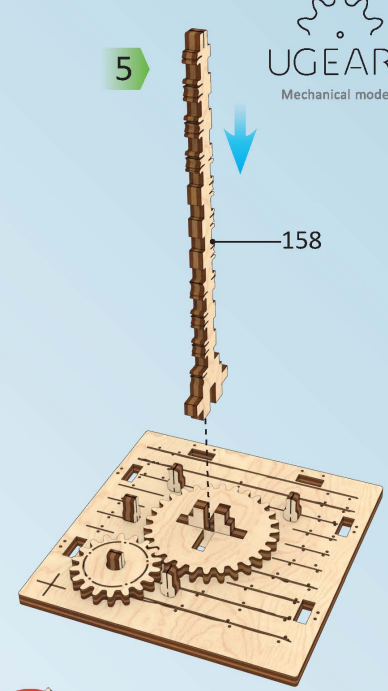
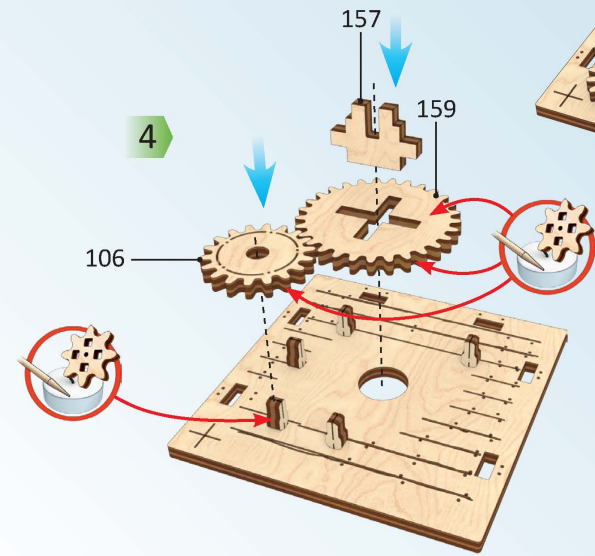
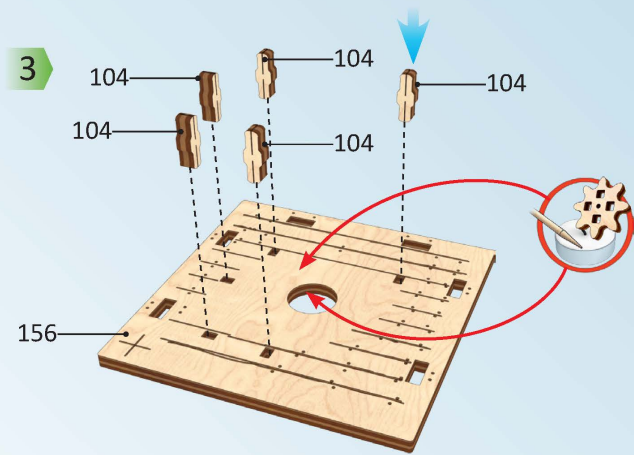
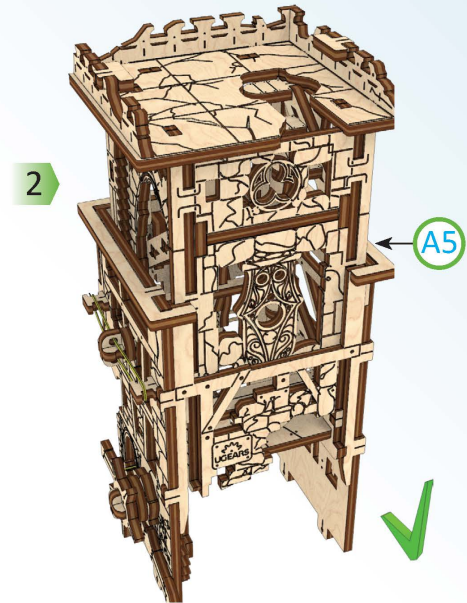
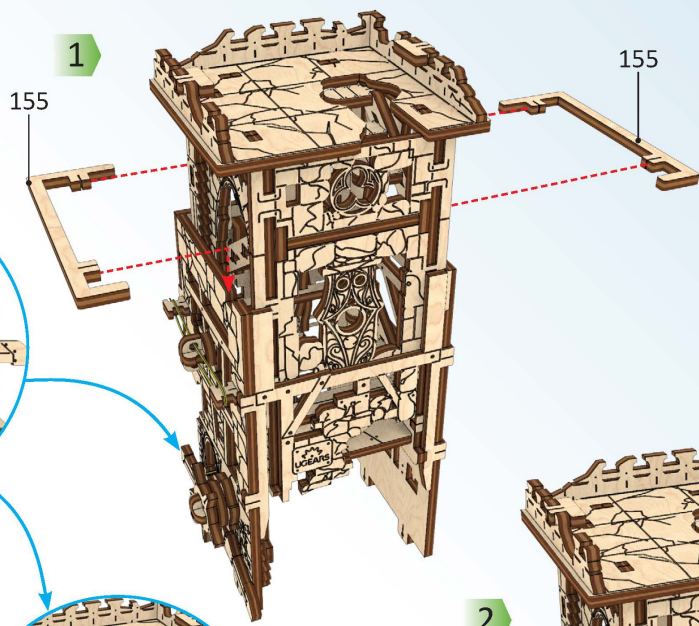
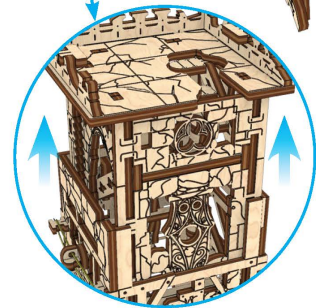
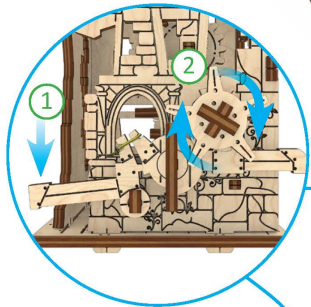
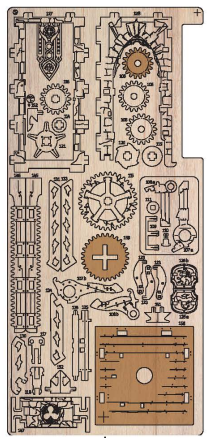
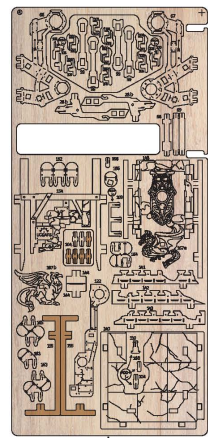
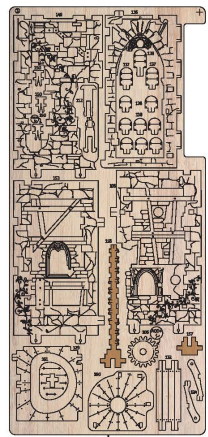

Mechanical models

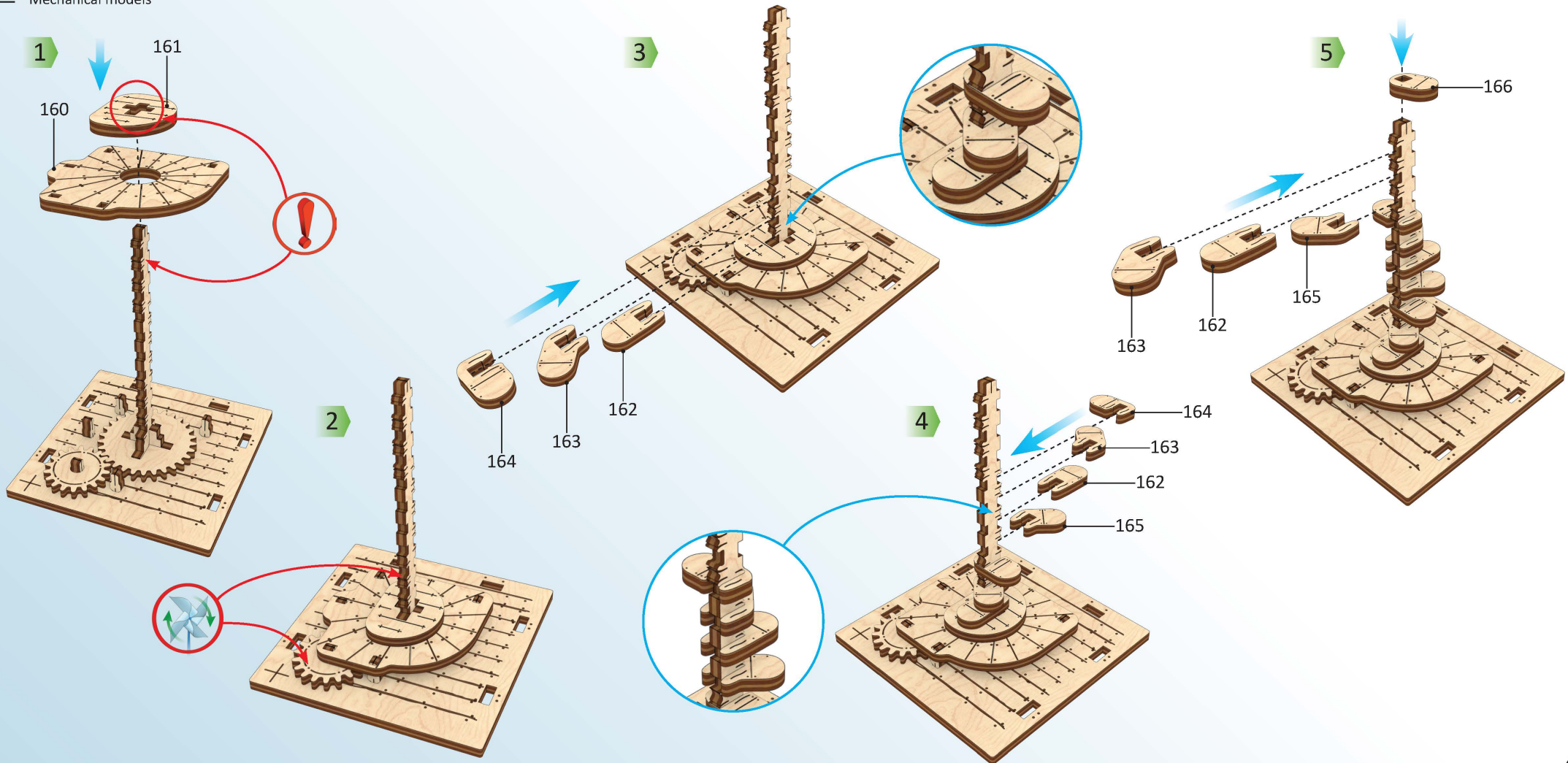
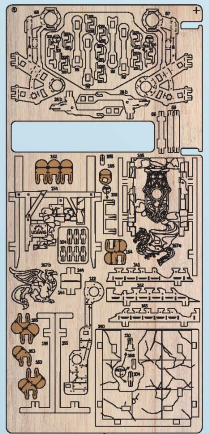
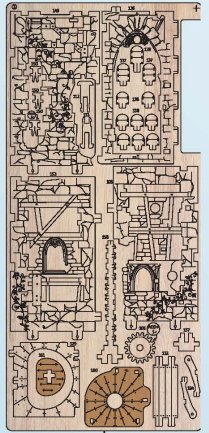

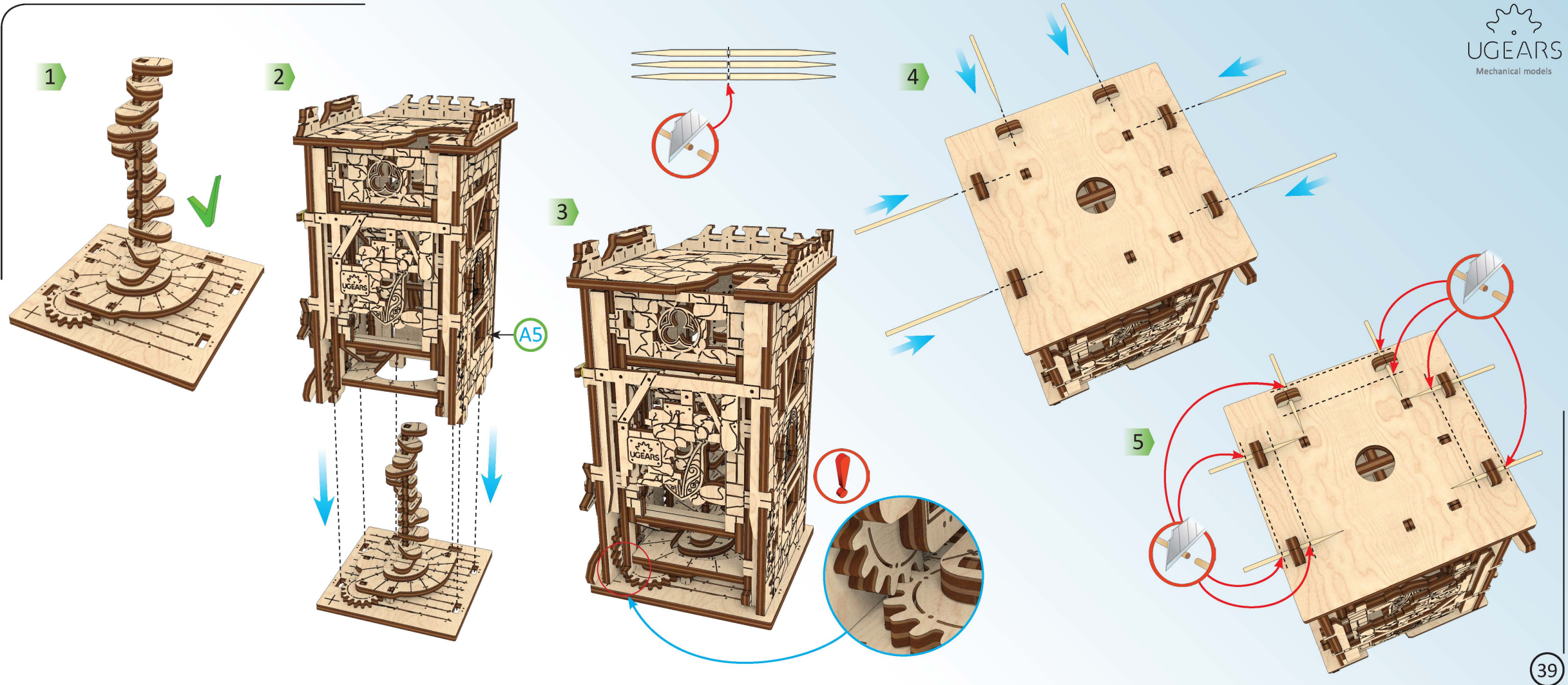

1

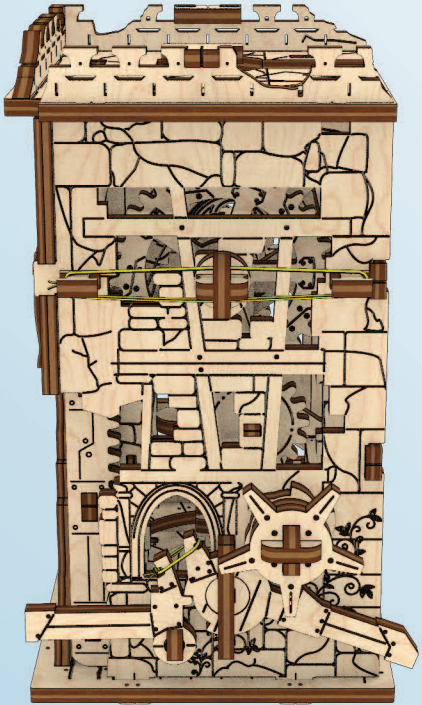

2

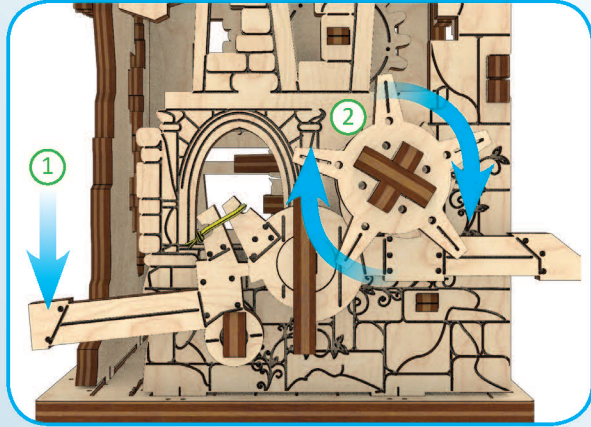

3

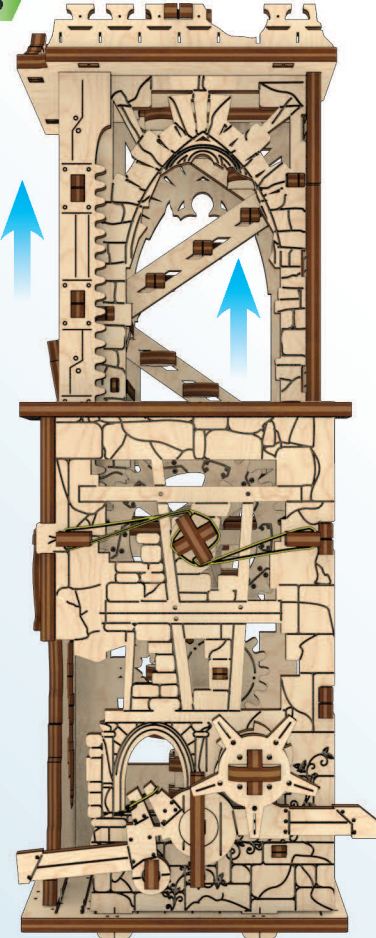

4

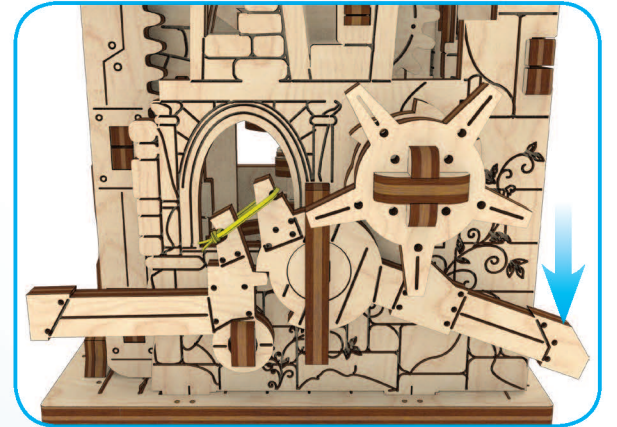

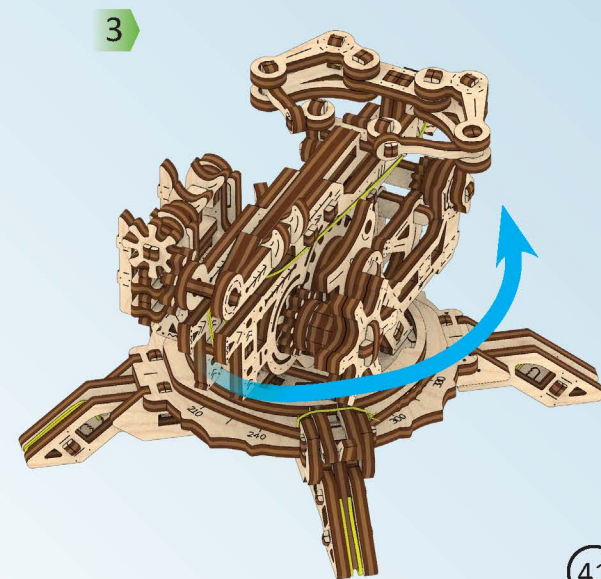
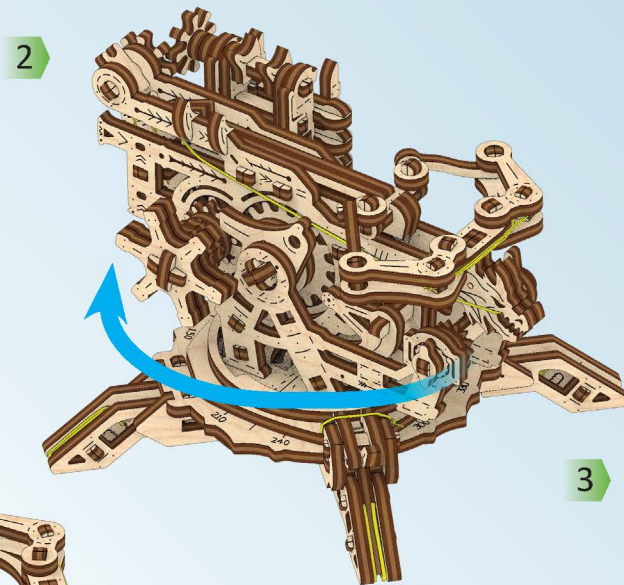
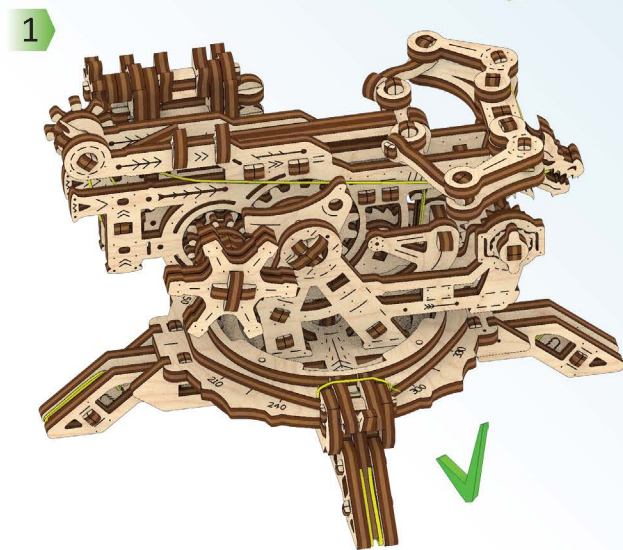
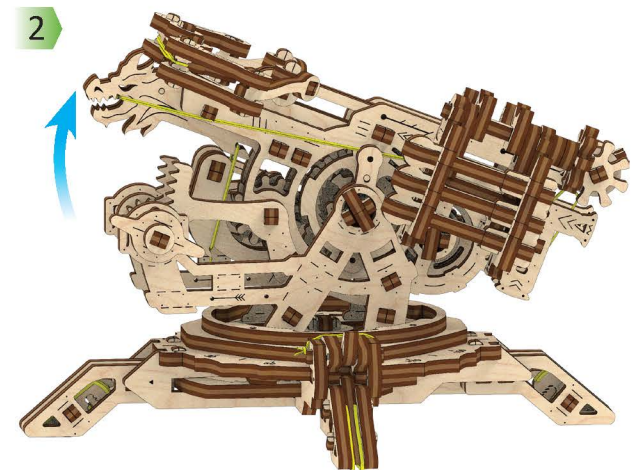
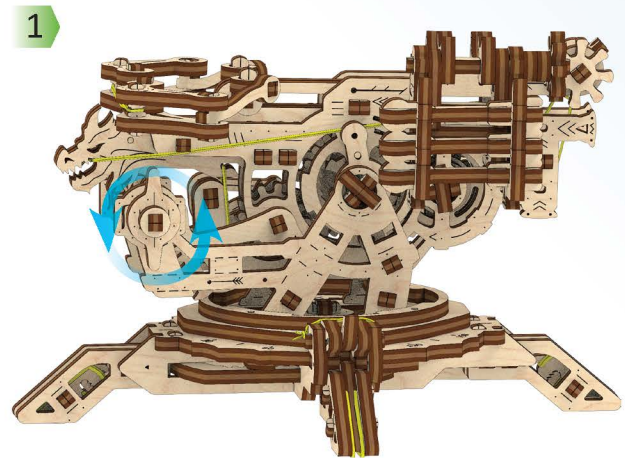

1

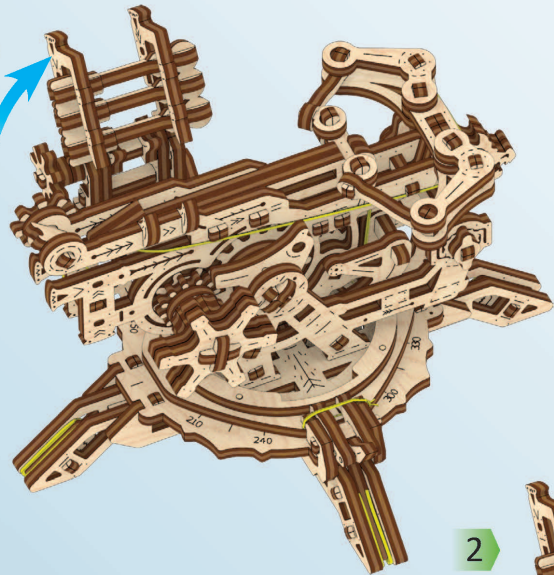

2



3



4

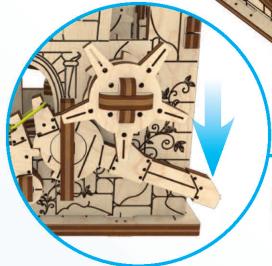
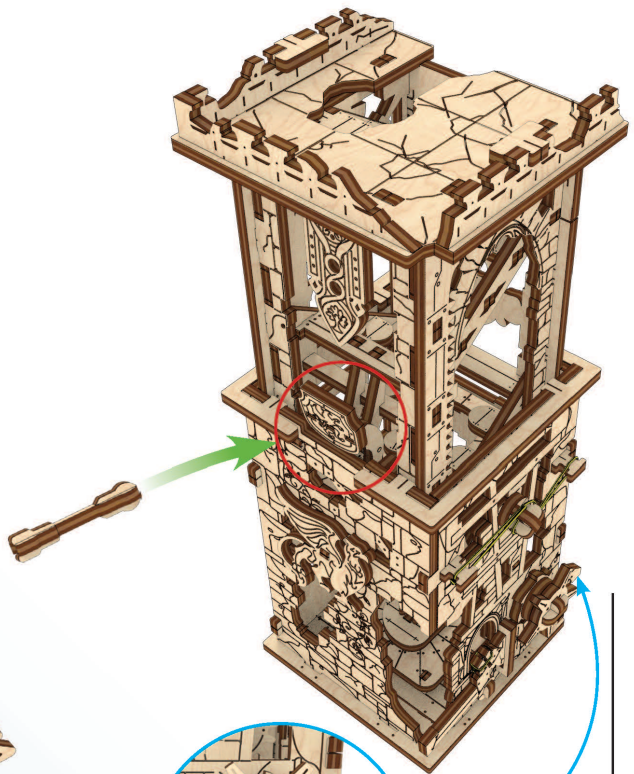
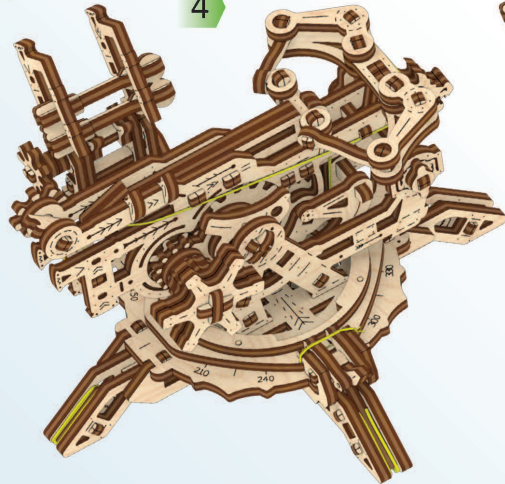

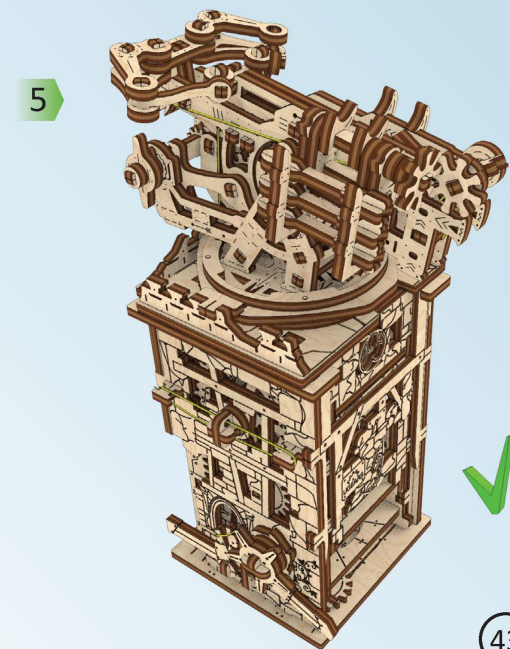
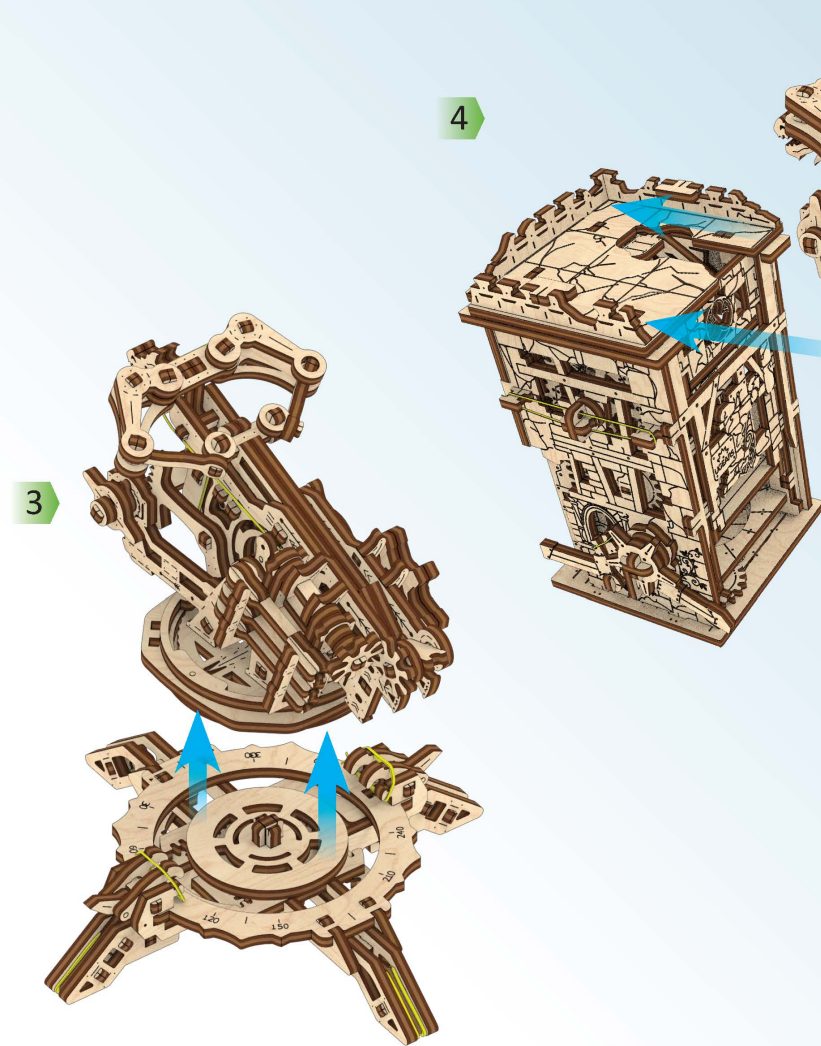
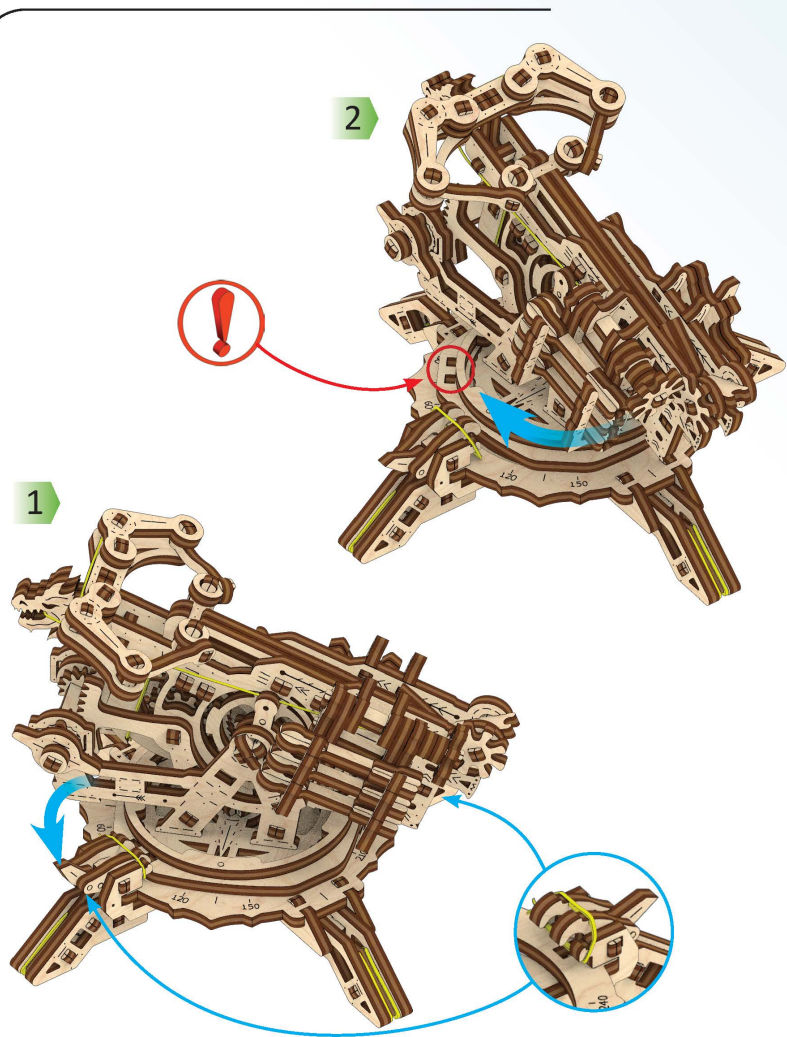



Mechanical models

ENG Thanks for following along on this journey with us. **UKR** Дякуємо, що ви пройшли цей шлях з нами. **DEU** Vielen Dank, dass Sie diesen Weg mit uns gegangen sind.

FRA Merci de nous avoir accompagnés tout au long de ces étapes. **POL** Dziękujemy, że razem z nami pokonałeś tę drogę! **SPA** Gracias por haber recorrido el camino con nosotros. **ITA** Grazie per aver fatto uesto percorso con noi. **TUR** Bizimle bu yolu geçtiğiniz için teşekkür ederiz. **RUS** Спасибо, что вы прошли этот путь с нами. **KOR** UGEARS와 함께해 주셔서 감사합니다. **CHI** 感谢您参与有趣的模型装配过程。

ugearsmodels.com

