

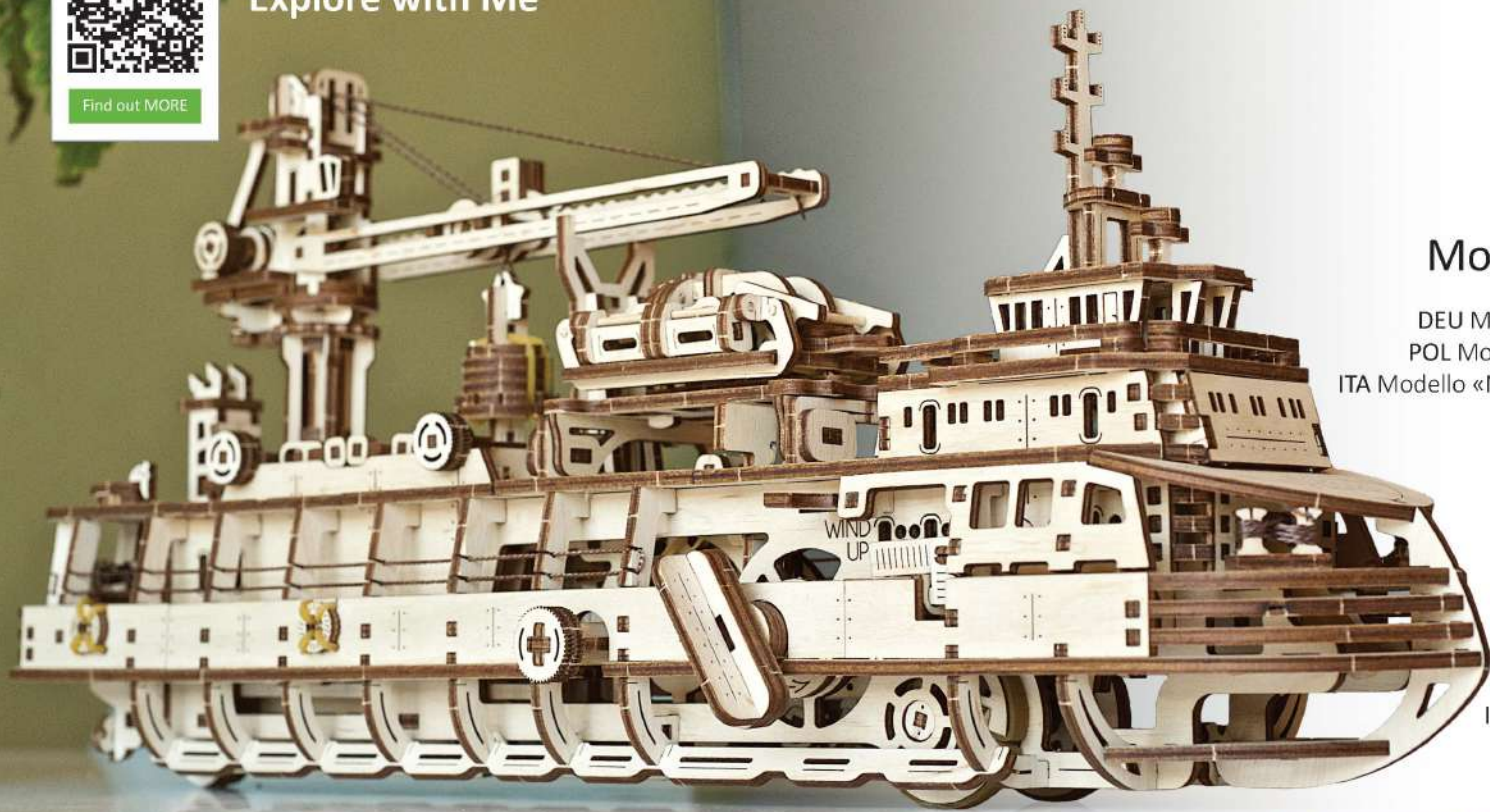

Assemble Me.
Explore with Me

Find out MORE



UGEAR.S®

Mechanical models

Model «Research Vessel» Модель «Науково-дослідне судно»

DEU Modell «Forschungsschiff». FRA Modèle «Navire de recherche».
POL Model «Statek badawczy». SPA Modelo «Buque de investigación».
ITA Modello «Nave da Ricerca». RUS Модель «Научно-исследовательское судно».
JAP リサーチベッセル KOR 연구선 CHI 科考船

Assembly instructions Інструкція зі складання

DEU Aufbauanleitung. FRA Notice d'assemblage.
POL Instrukcja montażu.
SPA Instrucciones de montaje.
ITA Istruzioni di montaggio. RUS Инструкция по сборке.
JAP 組み立て説明書 KOR 조립 설명서.
CHI 装配说明书



NATURAL



NO GLUE
CONNECTION



SELF ASSEMBLY



MECHANICAL



EDUCATIONAL

ENG

Assembly instructions:

Remove model parts from the hanger board as illustrated below. Careful not to break parts. If a part does not remove easily, carefully cut it out with a knife. This model is intended for self-assembly without glue. If you have difficulty installing the axles, try waxing them with a regular candle. All moving parts can also be waxed during assembly to reduce friction when operating the model.

UKR

Інструкція зі складання:

Витягніть з дошки позначені на схемі деталі. Намагайтеся їх не зламати. Якщо деталь не виймається, надсічіть перемички ножом. Конструкція збирається без клею. У разі виникнення труднощів з протягуванням вісі в отвір, потріть деталь об звичайну свічку. Також можна змастити свічкою всі деталі механізму, що рухаються, щоб зменшити тертя при обертанні.

DEU

Aufbauanleitung:

Bitte die in der Zeichnung angegebenen Teile aus der Platte herausnehmen. Versuchen Sie bitte diese nicht zu brechen. Wenn sich ein Teil nicht herausnehmen lässt, schneiden Sie die Stege mit dem Messer leicht an. Das Modell wird ohne Klebstoffe zusammengebaut. Lässt sich eine Achse nur schwer in eine Öffnung einführen, reiben Sie diese mit einer Kerze etwas ein. Für besseres Gleiten schmieren Sie alle beweglichen Teile mit einer Kerze.

FRA

Notice d'assemblage:

Faites sortir de la planche les pièces comme indiquées sur le schéma. Tâchez de ne pas les casser. Si la pièce ne sort pas, incisez les collages/fixations avec un couteau. La construction est à assembler sans colle. Si il est difficile d'introduire l'axe en bois dans l'orifice, frottez au préalable l'axe ou les pièces contre une bougie. Pour améliorer le glissement, traitez les pièces de frottement mobiles du mécanisme avec une bougie au cours d'assemblage.

POL

Instrukcja montażu:

Delikatnie wyciągaj z deseczki wskazane w schemacie detale, starając się nie połamać elementów. Jeśli detal nie poddaje się, podetnij wiązadła nożem. Konstrukcje składa się bez kleju. Jeśli napotkasz trudności z instalacją drewnianej osi w otwór, potrzyj na początku oś lub detale o woskową świecę. Dla lepszego poślizgu polecano smarowanie ruchomych części mechanizmu zwykłą świecą podczas montażu.

SPA

Instrucciones de montaje:

Saque de la tabla las piezas marcadas en el esquema. Trate de no romperlas. Si una pieza no se saca, haga una incisión. La construcción va sin pegamento. Si tiene dificultades con la instalación del eje de madera en un agujero, frote primero el eje o las piezas contra una vela. Para un mejor deslizamiento, lubrique durante el montaje las piezas móviles del mecanismo con una vela común.

ITA

Istruzioni di montaggio:

Estrarre dal telaio i particolari indicati nello schema. Fare attenzione a non romperli. Se un particolare non si stacca, tagliare delicatamente gli elementi di collegamento con un coltello. L'assieme viene realizzato senza colla. In caso di difficoltà nell'inserimento di un perno in legno, è necessario sfregare il perno o il particolare con un po' di cera. Per uno scorrimento migliore incerare le parti mobili del meccanismo durante l'assemblaggio.

RUS

Инструкция по сборке:

Вынимайте из доски обозначенные на схеме детали. Старайтесь их не сломать. Если деталь не извлекается, надрежьте перемычки ножом. Конструкция собирается без клея. Если возникли трудности с установкой деревянной оси, перед установкой потрите детали об обычную свечу. Для лучшего скольжения смазывайте движущиеся детали механизма обычной свечой во время сборки.

JAP

組み立て説明書:

部品に傷をつけないように注意しながらボードから外してください。部品が外れにくい場合は連結部分をカッターで切ってから外すと外しやすいです。本製品は、接着剤がなくても組み立てができるように設計されています。もしアクスル(駆動部)が、歯車の動きがにぶい場合は、口ウソクをアクスルに塗ってください。全ての駆動部分は製品を動かす時、滑らかに動くように潤滑剤である口ウソクを塗りながら組み立てます。

KOR

조립 설명:

부품이 손상되지 않도록 주의하여 보드에서 떼어냅니다. 만약 부품이 잘 떨어지지 않으면 연결 부분을 칼로 잘라 한 후 떼어내면 쉽게 떼어 낼 수 있습니다. 만약 축이 잘 끼워지지 않는 경우 양초를 축에 바른 후 끼워 보세요. 모든 구동 부위는 제품 구동 시 원활한 작동이 가능하도록 조립 과정에서 윤활제(양초)양초를 발라 주세요.

CHI

装配说明

将模型部件按插图示,从胶合板取下。小心不要损坏件。如果取下时候有难度,请用小刀小心的切割连接点。这个产品不需要胶水粘接。如果安装转轴的的时候有难度,请用普通的蜡加以润滑。所有的转动部分也需要打蜡润滑。

ENG Warning! UKR Увага! DEU Achtung! FRA Attention! POL Uwaga! SPA Precaución! ITA Attenzione! RUS Внимание! JAP 注意! KOR 주의! CHI 注意!



ENG Do not use a lighted candle! **UKR** Не підпалювати!
DEU Nicht anzünden! **FRA** Ne pas brûler! **POL** Nie podpalać!
SPA ¡No encender! **ITA** Non dare fuoco! **RUS** Не поджигать!
JAP 火のついた口ウソクの使用はお止めください。
KOR 불이 붙은 초를 이용하지 마세요! **CHI** 请勿点燃, 请勿靠近火源!



ENG Wax the part with a regular candle (rub with a candle). **UKR** Змастит деталь звичайною свічкою (потрить об свічку). **DEU** Reiben Sie das Teil mit einer einfachen Kerze etwas ein. **FRA** Lubrifiez la pièce avec une bougie ordinaire (frottez contre la bougie). **POL** Przesmaruj zwykłą świecą. **SPA** Engrase la pieza con una vela común (frote con una vela). **ITA** Incerare il componente (sfregare con la cera). **RUS** Смажьте деталь обычной свечкой (потрите о свечку). **JAP** された部分に潤滑剤としてロウソクを塗ってください。 **KOR** 표시된 부분에 윤활을 위해 촛을 칠해 주세요. **CHI** 用普通蜡烛涂抹润滑部件



ENG Sand to remove burrs. **UKR** Видаліть задирки. **DEU** Grate entfernen. **FRA** Éliminez les bavures. **POL** Usun zadziory. **SPA** Quite las rebabas. **ITA** Togliere le bave. **RUS** Удалите заусенцы. **JAP**バリ取りのサンドペーパー **KOR** 거친 부분을 다듬어 주세요. **CHI** 磨掉毛刺



ENG Pay attention. Check position of the part. **UKR** Зверніть увагу. Перевірте розташування елемента. **DEU** Bitte Beachten. Prüfen Sie die Einbaulage des Elementes. **FRA** Faites attention. Vérifiez la disposition de l'élément. **POL** Zwróć uwagę. Sprawdź lokalizację elementu. **SPA** Atención. Compruebe la situación del elemento. **ITA** Prestare attenzione. Controllare la posizione del componente. **RUS** Обратите внимание. Проверьте расположение элемента. **JAP** 方向及び位置に注意して組み立ててください。 **KOR** 방향 또는 위치에 주의해서 조립해 주세요. **CHI** 注意! 检查部件方向和位置



ENG Break off or cut out. **UKR** Відламайте або відріжте. **DEU** Abbrechen oder Abschneiden. **FRA** Coupez ou cassez. **POL** Odłam lub odetnij. **SPA** Rompe o corte. **ITA** Staccare o tagliare. **RUS** Отломайте или отрежьте. **JAP** 切ってください。 **KOR** 잘라내 주세요. **CHI** 切断



ENG Perform the same steps in mirror image. **UKR** Здійснити аналогічне складання у дзеркальному відображенні. **DEU** Den analogen Zusammenbau in der Spiegelreflexion zu machen. **FRA** Procédez à l'assemblage dans le sens opposé (inverse). **POL** Dokonać analogiczny montaż w odbiciu lustrzanym. **SPA** Haga un ensamblaje similar en imagen especular. **ITA** Realizzare lo stesso assemblaggio nell'immagine speculare. **RUS** Произвести аналогичную сборку в зеркальном отражении. **JAP** 同じ部品を対称となるようにペアで作業してください。 **KOR** 대칭 모양으로 한 쌍을 만들어 주세요. **CHI** 在镜面对称执行相同的步骤



ENG Press the parts as far as they will go. **UKR** Притисніть деталі до упору. **DEU** Drücken Sie die Teile bis zum Anschlag. **FRA** Pressez les pièces à fond. **POL** Przyciśnij element, aż do oporu. **SPA** Pulse para detener las piezas. **ITA** Stingere bene i componenti. **RUS** Прижмите детали до упора. **JAP** 部品をできる限り押してください。 **KOR** 부품을 양쪽에서 눌러서 고정해 주세요. **CHI** 用力紧密组合部件



ENG Do not fully press the outer parts (structural frame) together until checking for fit and alignment of internal parts. **UKR** Діякий час не притискайте сильно деталі (рамки конструкції). **DEU** Drücken Sie die Teile (die Rahmen der Konstruktion) momentan nicht stark. **FRA** Ne pas forcer sur les pièces (cadre de la construction). **POL** Tymczasowo nie dociskaj elementów (ramy konstrukcji). **SPA** No presione temporalmente con fuerza las piezas (marco de la estructura). **ITA** Non stringere provvisoriamente i componenti con forza (base della costruzione). **RUS** Временно сильно не прижимайте детали (рамки конструкции). **JAP** 内部部品がしっかりと組み立てられる前に外部部品は強く押しながら固定してはいけません。 **KOR** 아직은 외부의 틀을 완전히 눌러서 고정하면 안됩니다. 다른 부품을 먼저 끼우세요. **CHI** 在检查内部零件的配合和对准之前，请暂时不要将外部零件（结构框架）完全压在一起。



ENG Check the mechanism for smoothness and accuracy of movement. Operate the mechanism so the parts would seat-in. **UKR** Перевірте механізм на плавність і точність ходу. Розробіть механізм. **DEU** Prüfen Sie den Mechanismus bezüglich der Laufruhe und der Genauigkeit des Ganges. Betätigen Sie den Mechanismus mehrmals. **FRA** Vérifiez si le mécanisme fonctionne en douceur et avec précision. Faites fonctionner le mécanisme jusqu'à son fonctionnement normal. **POL** Sprawdź płynność i dokładność ruchu mechanizmu. Dopracuj mechanizm. **SPA** Verifique la suavidad y precisión del mecanismo. Desarrolle el mecanismo. **ITA** Controllare la scorrevolezza e la precisione del movimento. Far funzionare il meccanismo. **RUS** Проверьте механизм на плавность и точность хода. Разработайте механизм. **JAP** 駆動部分が滑らかに動くかを確認しながら作業をすすめます。 **KOR** 구동 부분의 원활한 작동과 정확한 움직임을 확인하세요. **CHI** 检查机构的运行平稳度和精确度。调整机构。



ENG Check size. **UKR** Перевірте розмір. **DEU** Prüfen Sie die Größe. **FRA** Vérifiez la dimension. **POL** Sprawdź rozmiar. **SPA** Compruebe el tamaño. **ITA** Controllare le dimensioni. **RUS** Проверьте размер. **JAP** サイズをチェックしてください。 **KOR** 크기를 확인해 주세요. **CHI** 测量尺寸



ENG Spare parts. **UKR** Занасні деталі. **DEU** Ersatzteile. **FRA** Pièces de rechange. **POL** Części zamienne. **SPA** Piezas de repuesto. **ITA** Pezzi di ricambio. **RUS** Запасные детали. **JAP** 予備部品 **KOR** 여유 부품입니다. **CHI** 备用件

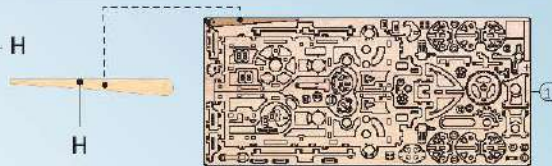
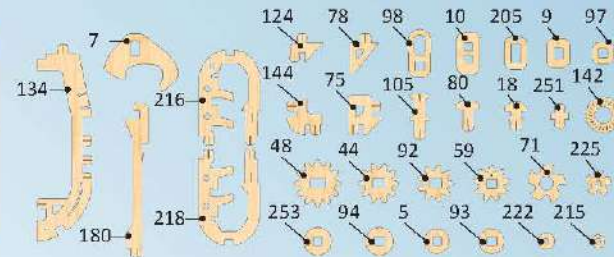

ENG This is not a structural component; it is a tool for measurement and assembly. **UKR** Це не деталь конструкції, а допоміжний інструмент для складання або вимірювання відстаней. **DEU** Es ist kein Teil der Konstruktion, sondern ein Hilfselement für den Zusammenbau oder für das Messen der Abstände. **FRA** Cette pièce ne fait pas partie de la construction mais constitue un outil annexe pour l'assemblage ou la mesure des distances. **POL** To nie detal konstrukcji, a pomocnicze narzędzie dla montażu i wymiaru odległości. **SPA** No es una pieza de la construcción sino un instrumento auxiliar para montar o para medir distancias. **ITA** Non è un componente del modello, ma un'attrezzatura aggiuntiva per il montaggio o il rilievo delle quote. **RUS** Это не деталь конструкции, а вспомогательный инструмент для сборки или измерения расстояний. **JAP** この部品は完成時の部品ではなく、組み立てをサポートしたり測定する道具です。 **KOR** 이 부품은 조립을 위한 부품이 아니고 조립을 돕거나 측정을 위한 도구입니다. **CHI** 这不是装配零部件，是一种测量及安装辅助工具。

Mechanical models

ENG It's easier to pull out some parts with the «helper (H)». **UKR** Буде легше видавити готові деталі за допомогою «helper (H)». **DEU** Es ist einfacher, einige Teile mit dem "Helfer (H)" herauszunehmen. Siehe Beispiel: **FRA** Il est plus facile de retirer certaines pièces avec la pièce-outils (H). **POL** Niektóre części łatwiej jest wyciągnąć za pomocą "pomocnika (H)". **SPA** Para separar algunas partes resulta más fácil utilizando la ayuda del elemento "H". **ITA** È più facile estrarre alcuni elementi utilizzando l' "aiuto (H)". **RUS** Будет легче выдвинуть готовые детали с помощью «helper (H)». **JAP** ある部品は「helper (H)」を使うと取り外しやすいです。 **KOR** 일부 부품은 'H' 도구를 이용하여 떼어내면 쉽니다. **CHI** 使用「helper (H)」可以更容易地拉出某些零件。

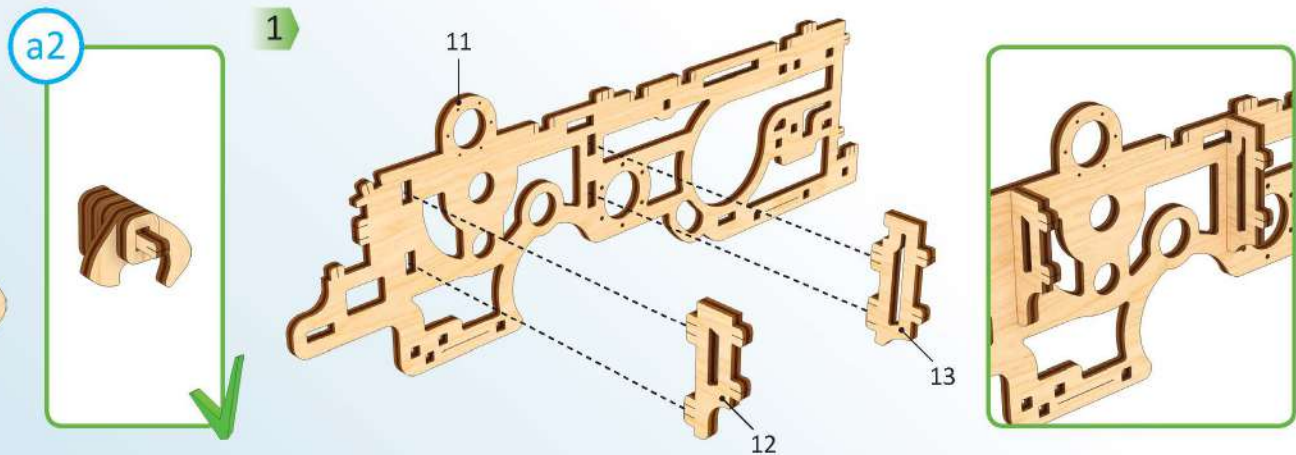
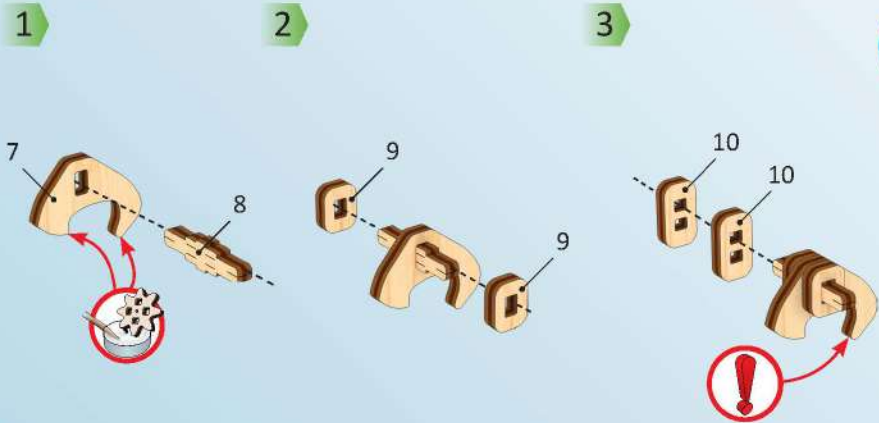
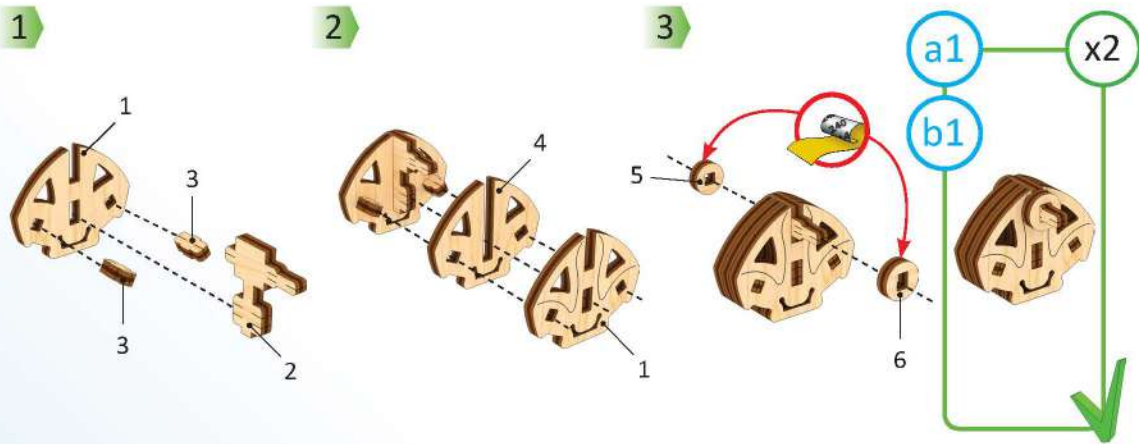
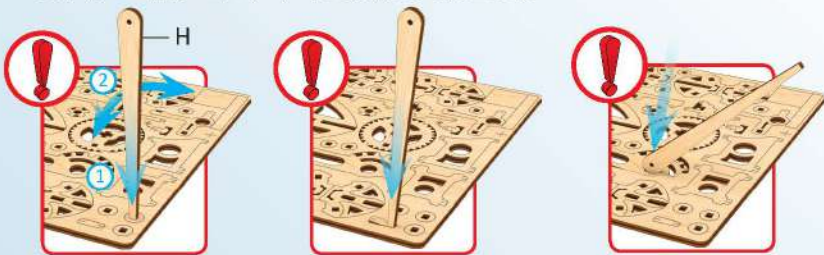
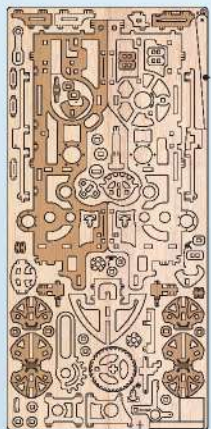

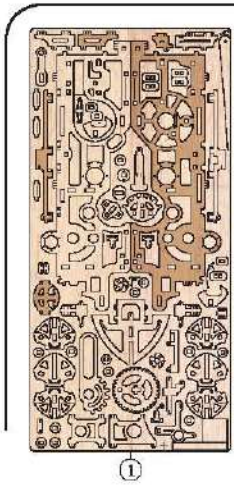

2

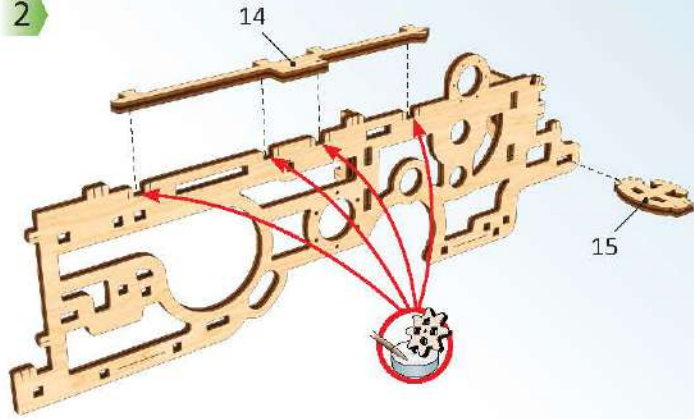

3

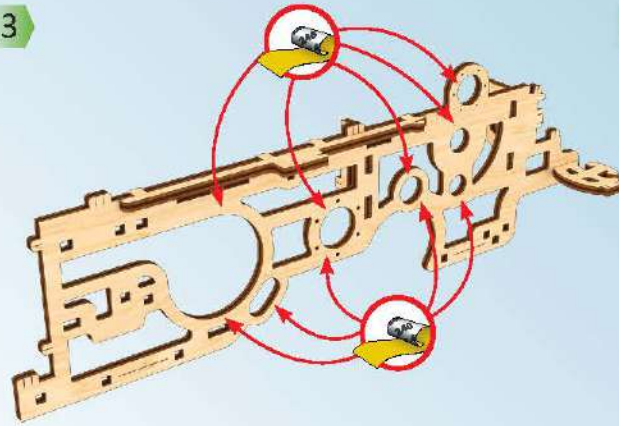

4

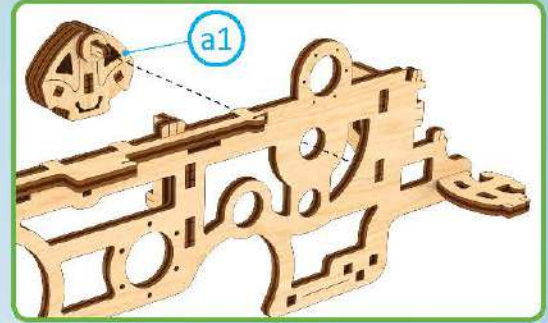

5

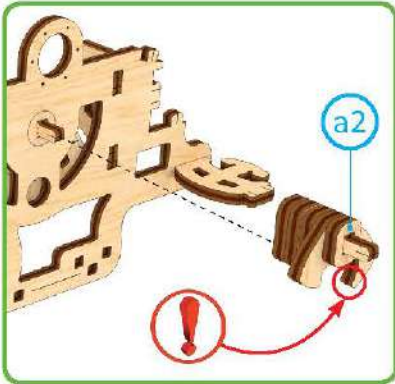

a3

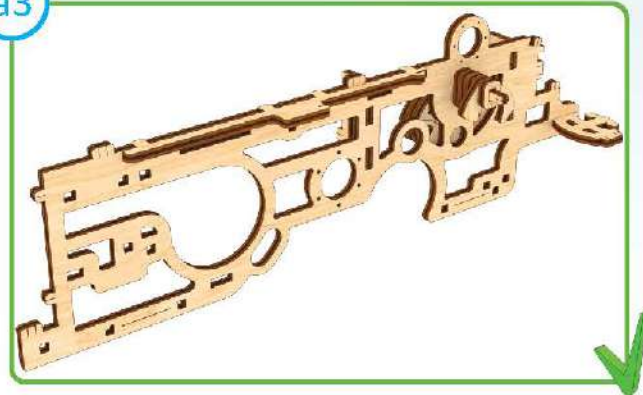

1

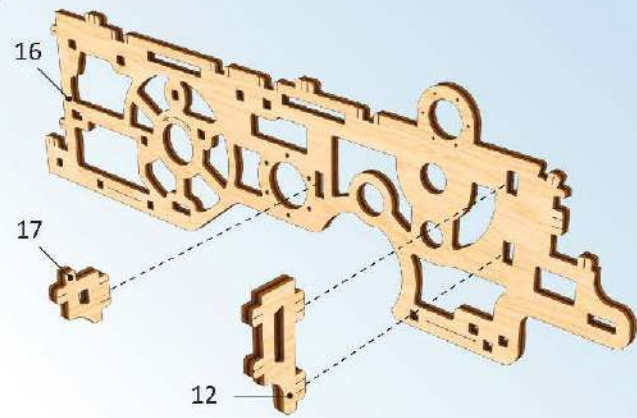

5

Mechanical models

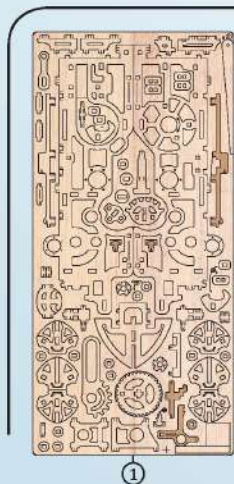

2

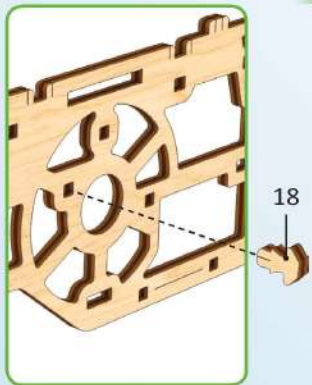

3



4

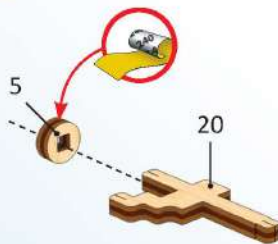

5

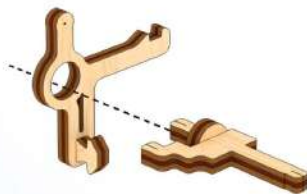

6

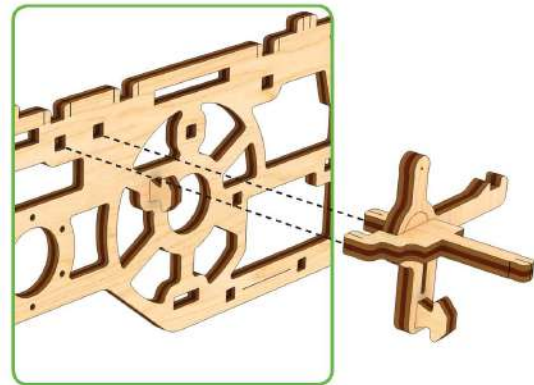

7

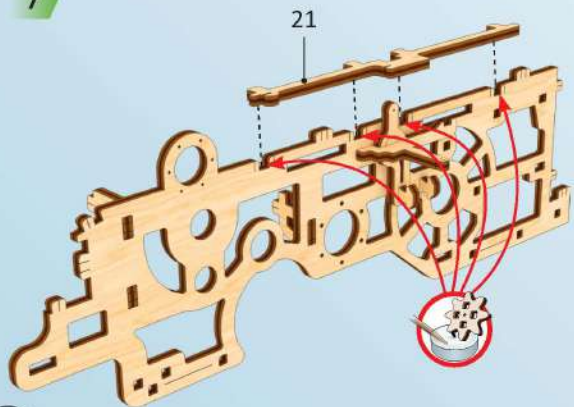

8

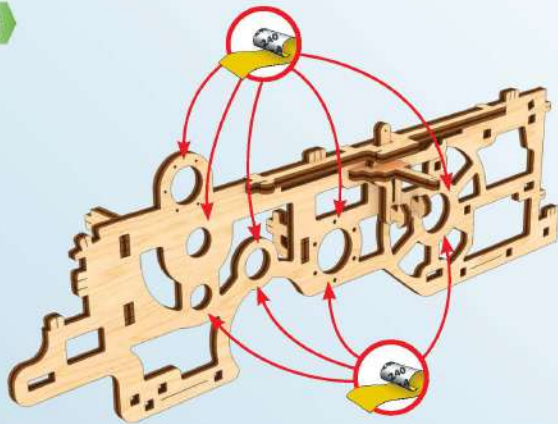

9

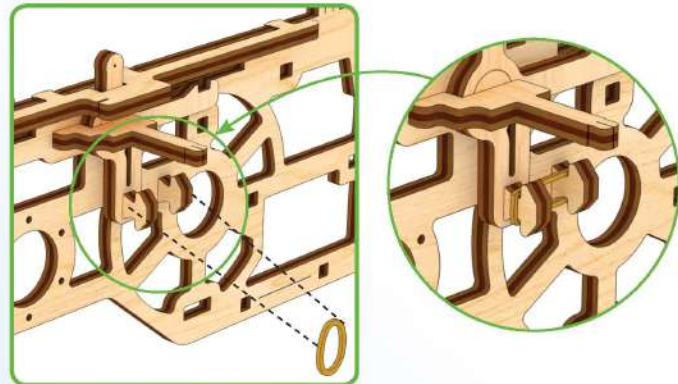
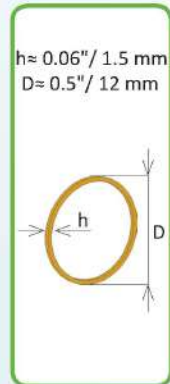

6

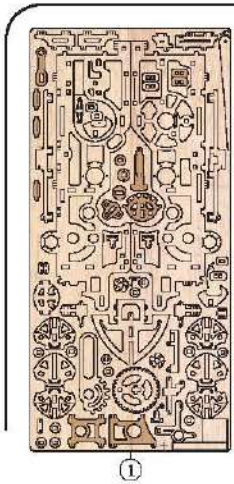

10

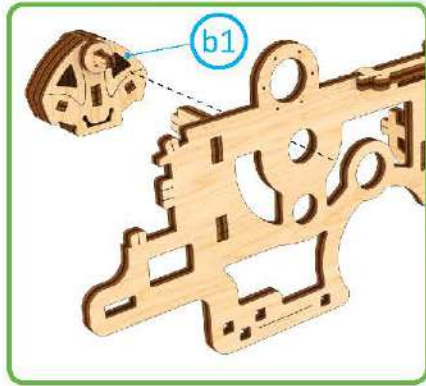

11

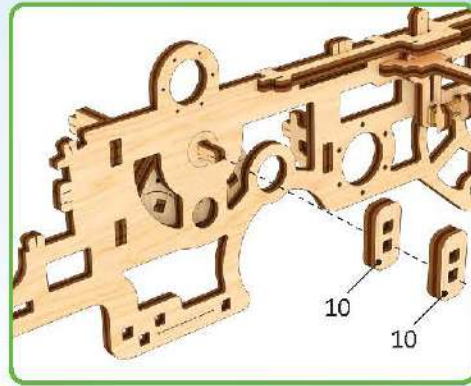

B

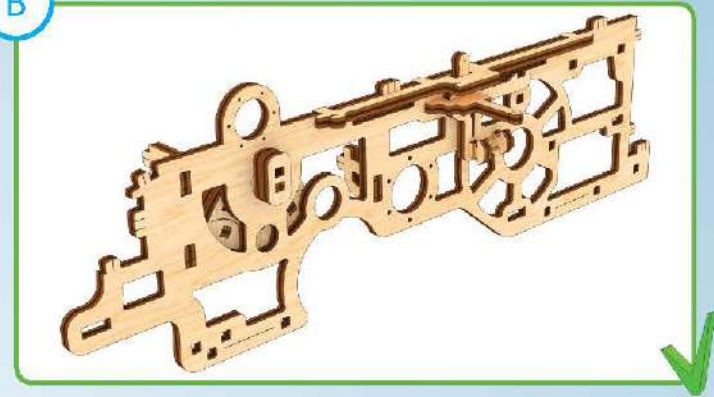

1

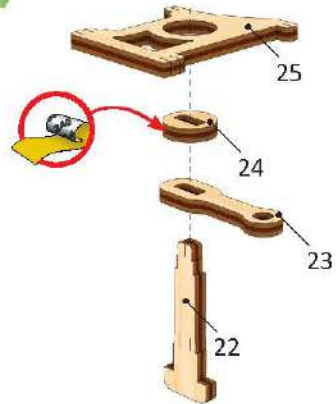

2

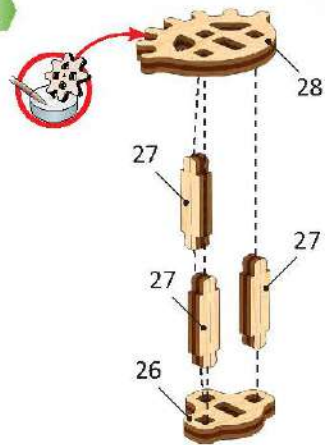

3

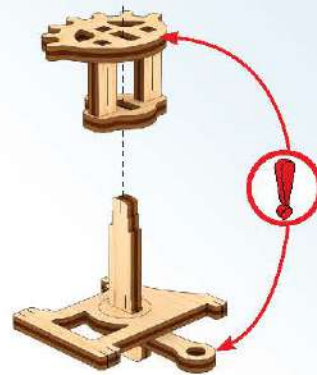

4

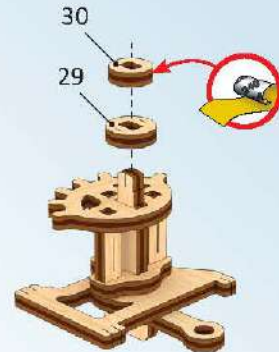

5



Mechanical models

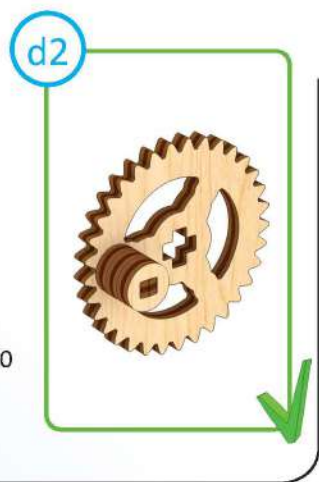
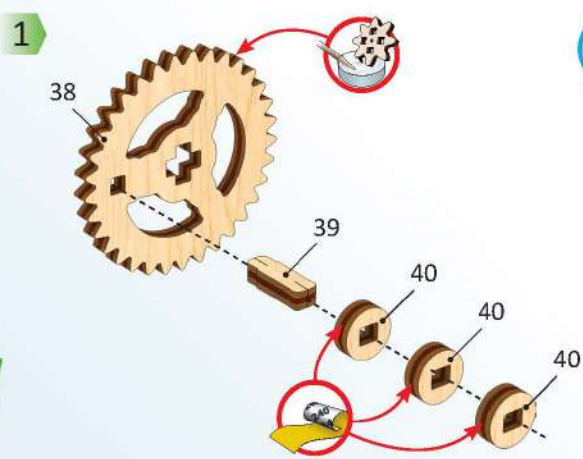
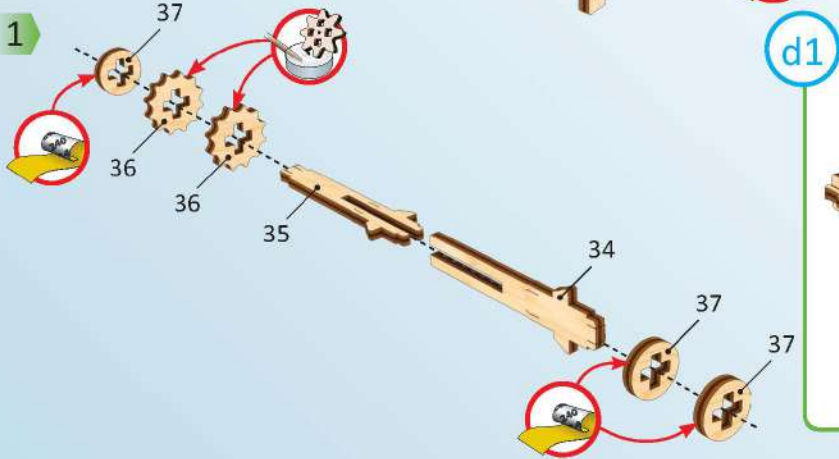
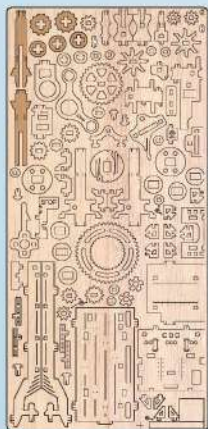
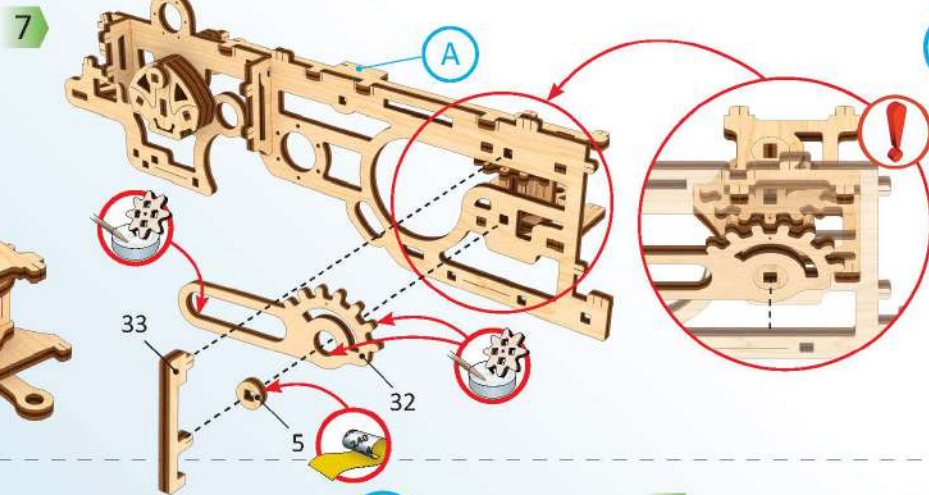
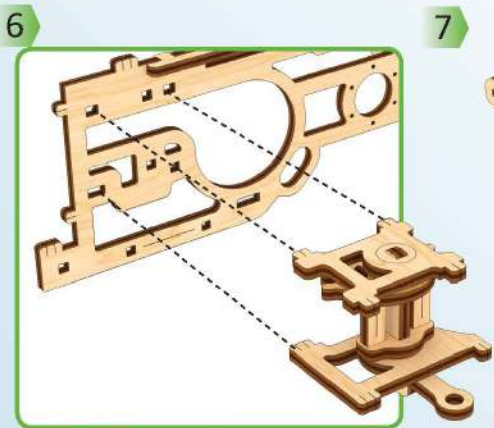
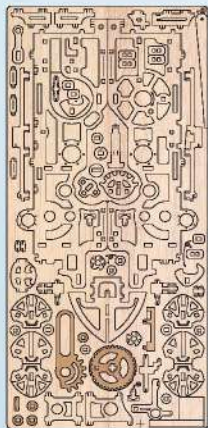

1



2

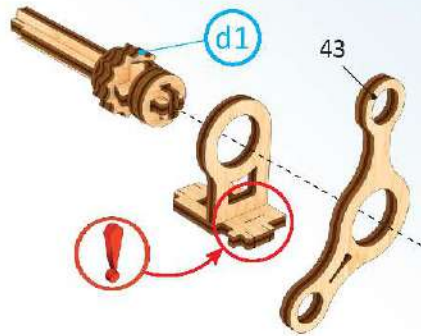

3



D

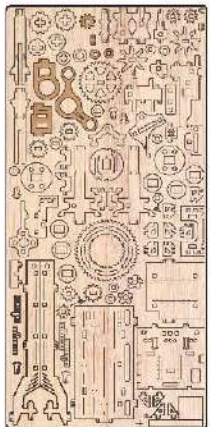

2

1

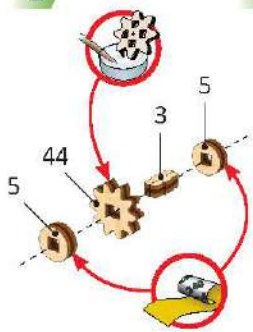

2

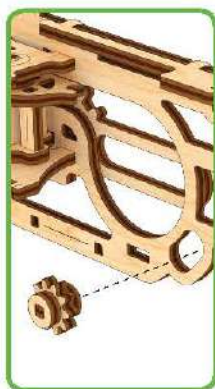

3

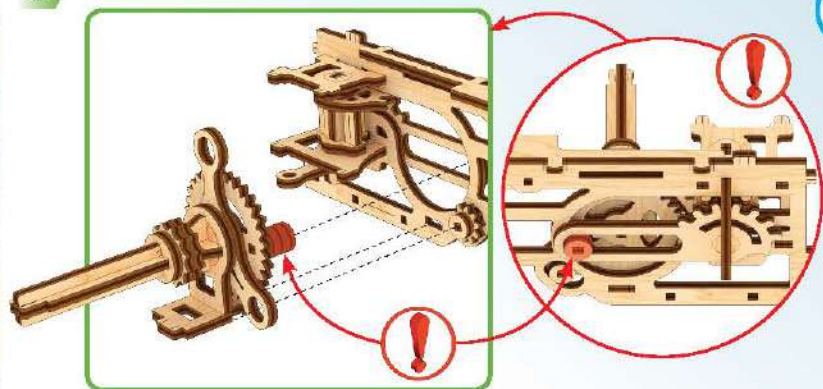

E

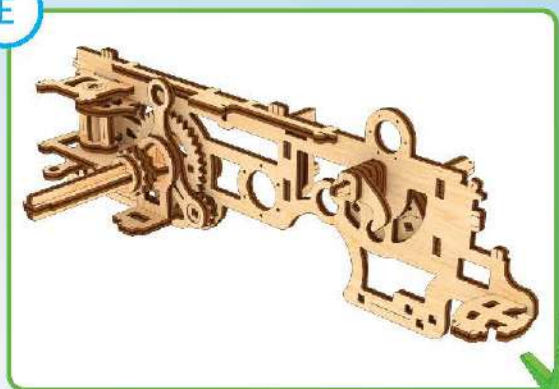

9

1

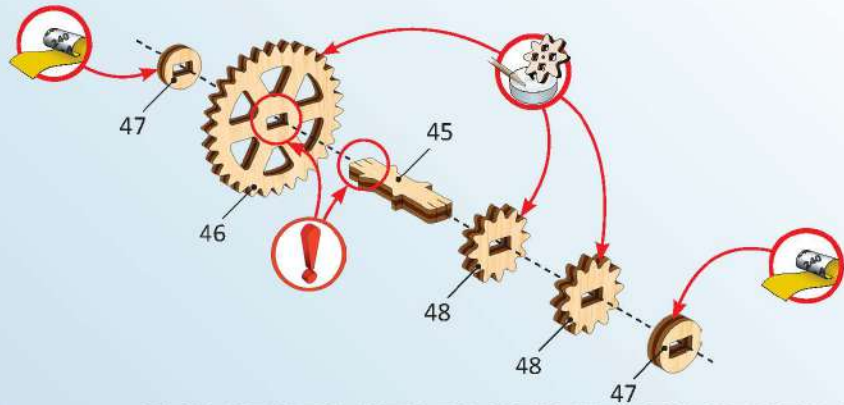

f1



1

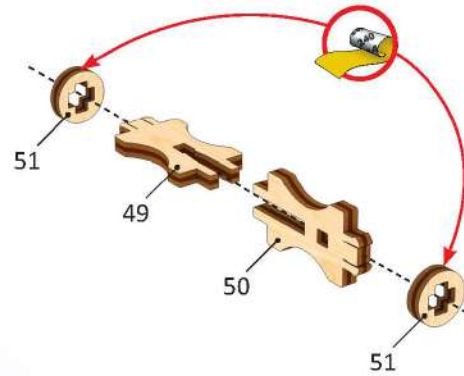

f2



1

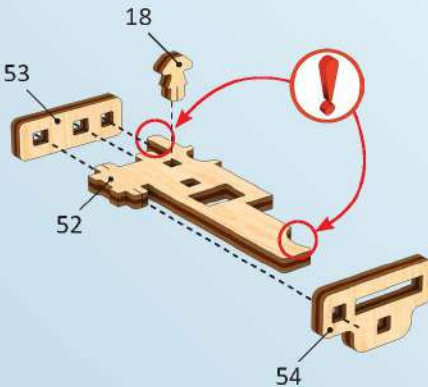

2

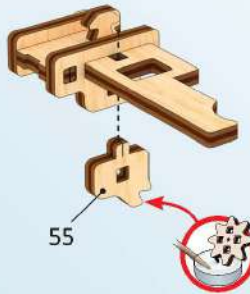

3

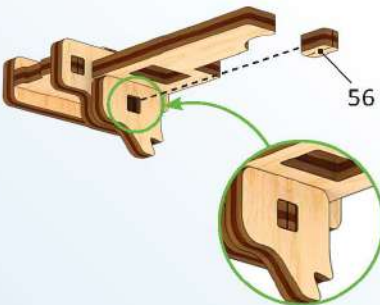

f3

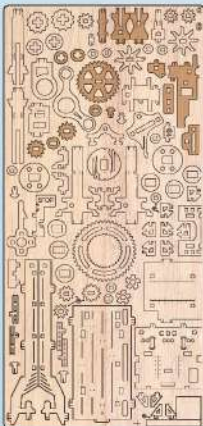

10

2

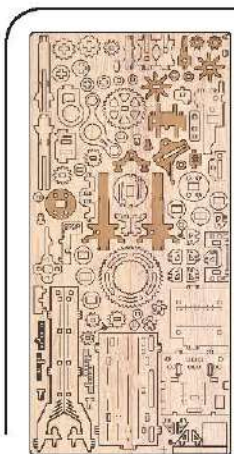

1

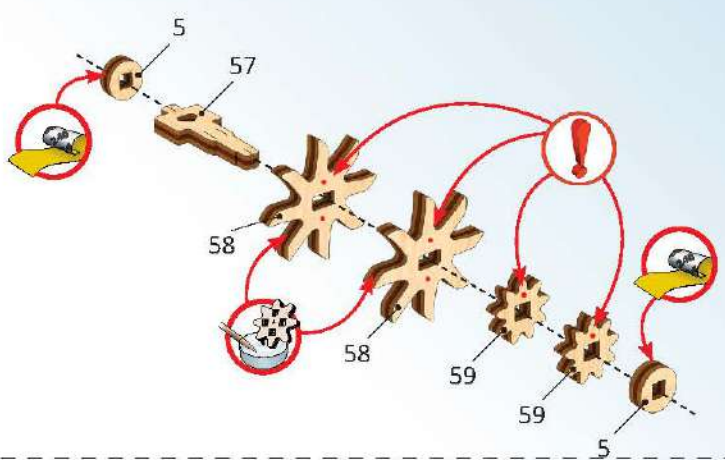

f4



1

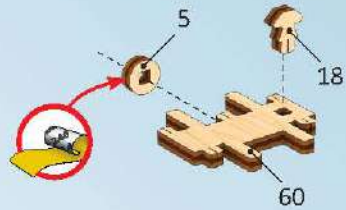

2

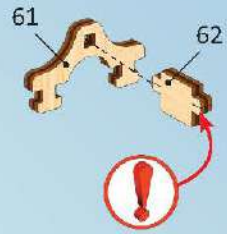

3

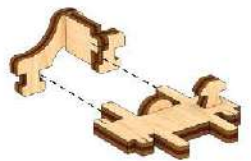

4

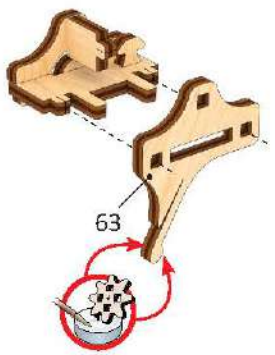

f5



1

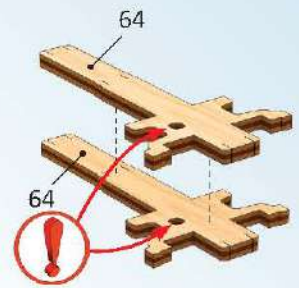

2

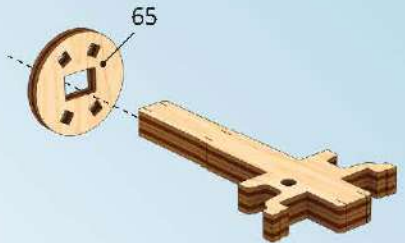

Nylon thread

$l \approx 7.9'' / 200 \text{ mm}$



$l \approx 3.1'' / 80 \text{ mm}$

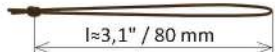

3



4

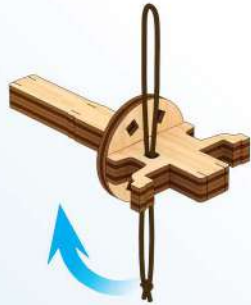

5

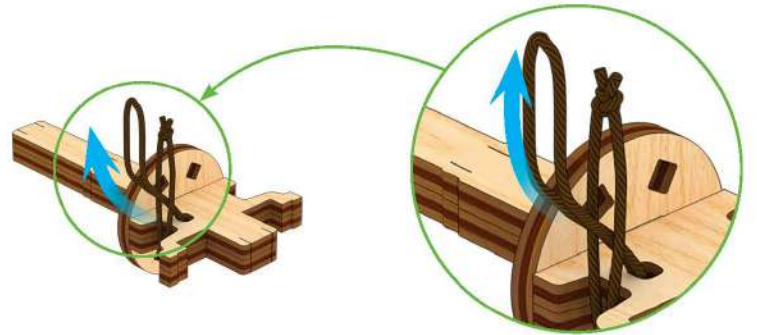

6

x2

$h \approx 0.2'' / 5 \text{ mm}$
 $D \approx 2.4'' / 60 \text{ mm}$

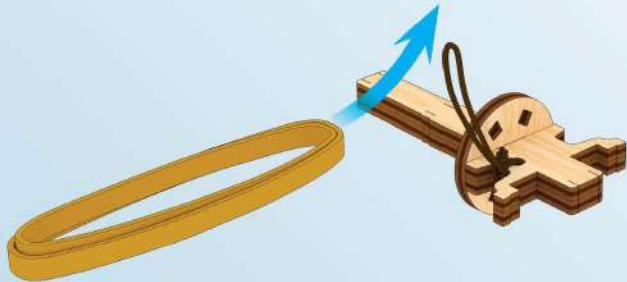
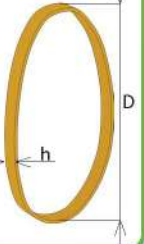

7

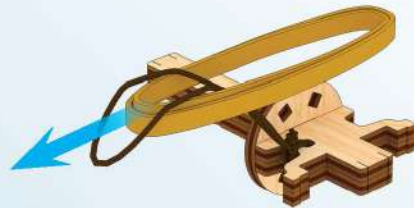

8



9

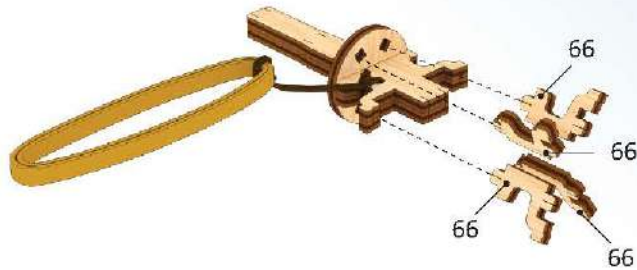

10

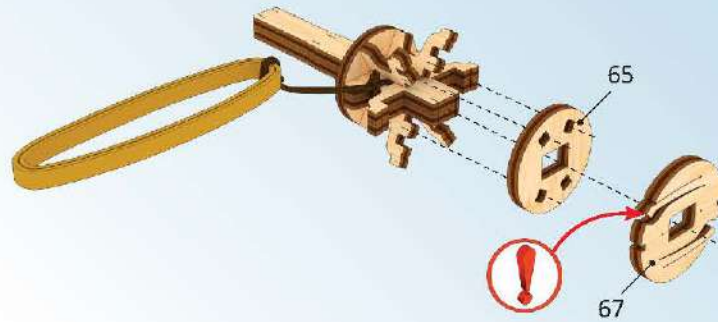

11

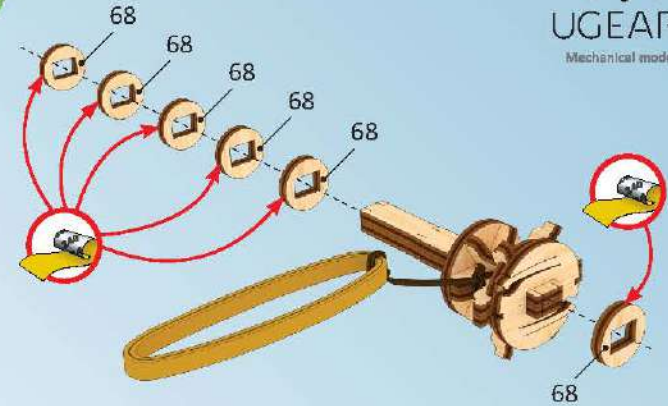

12

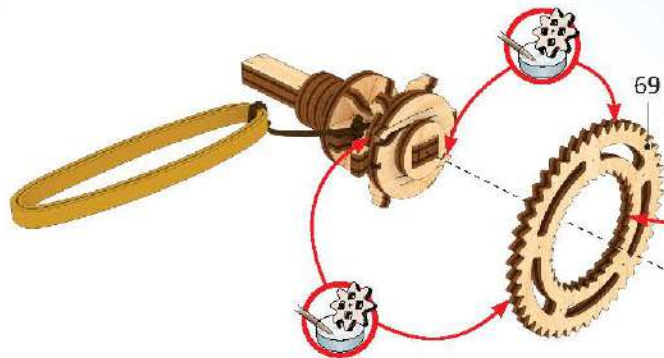

f6

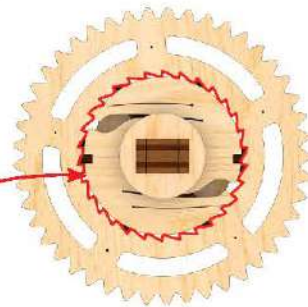

13

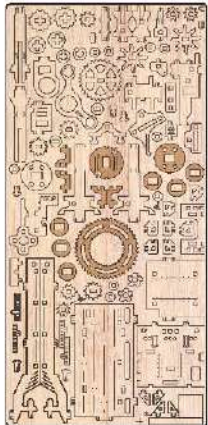

1

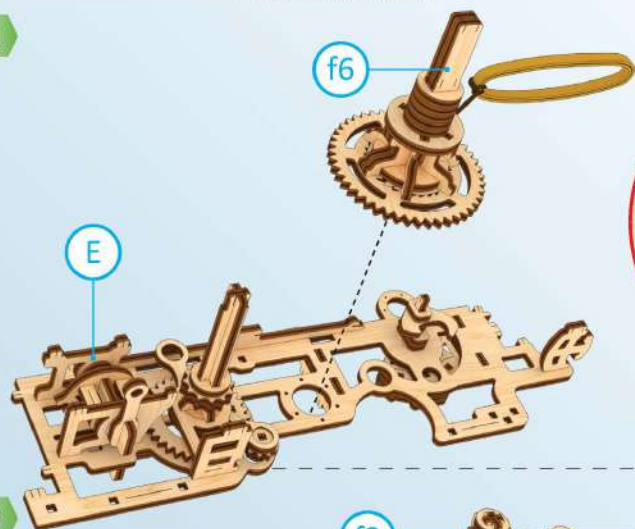

2

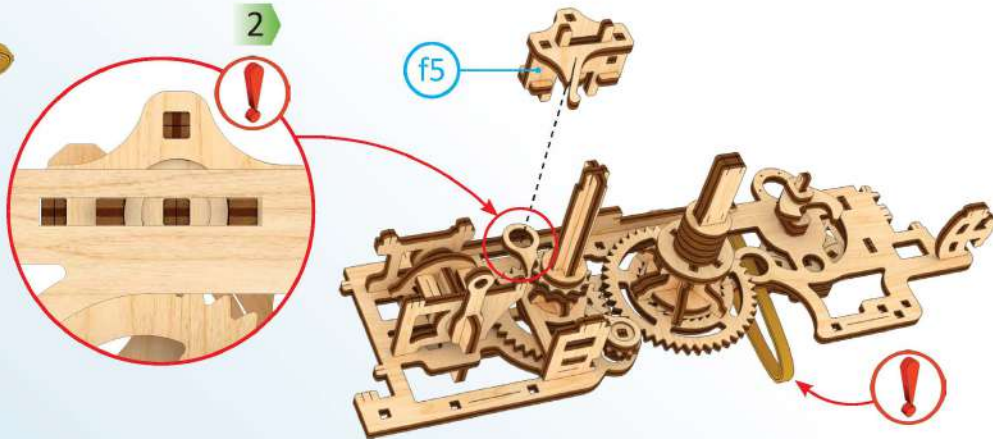

3

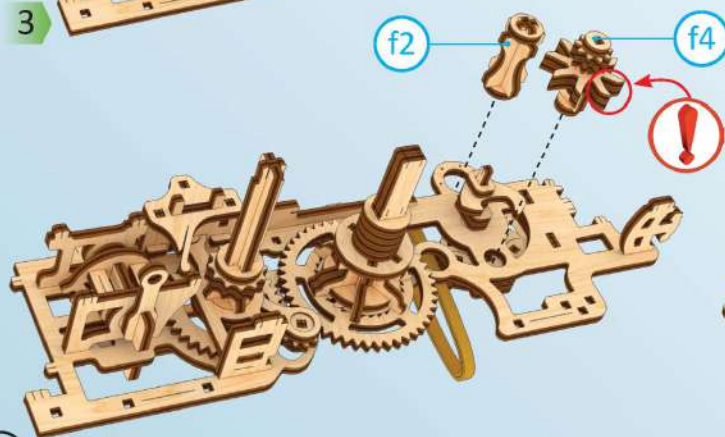

4

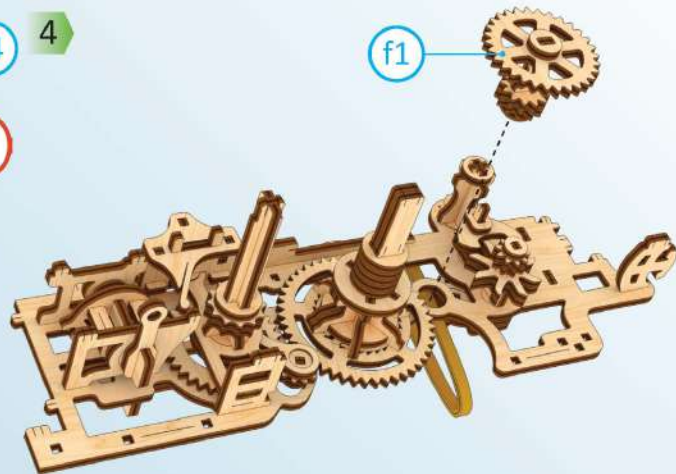

5

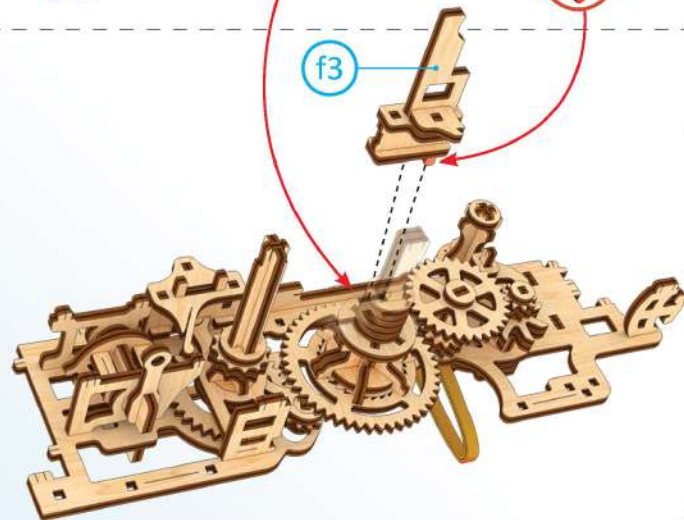

6

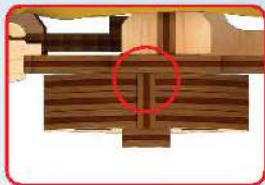
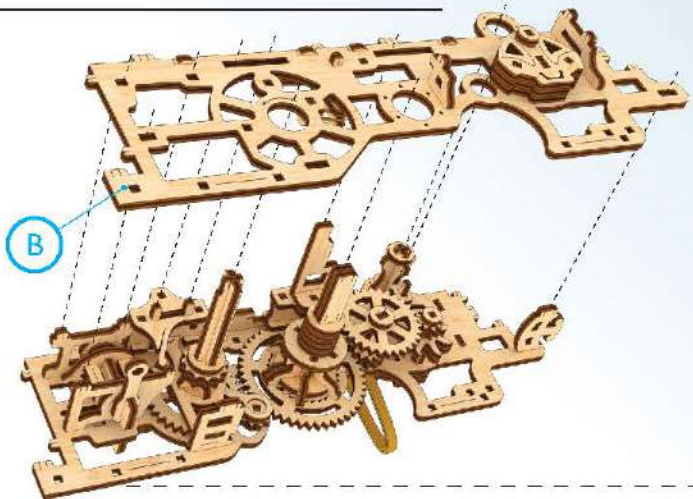

F

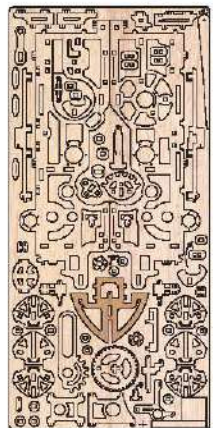

1

1



2

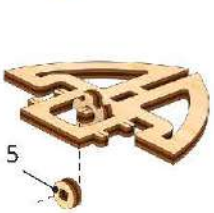

3

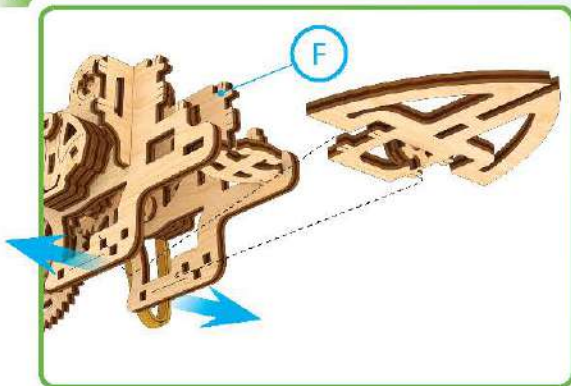

4



G

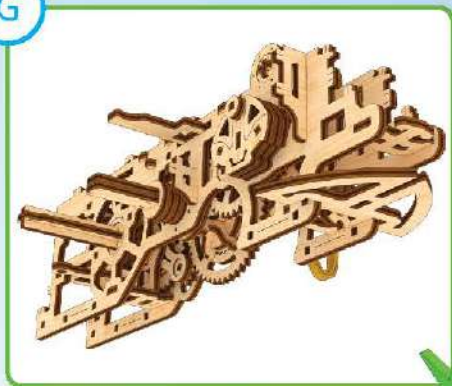

1

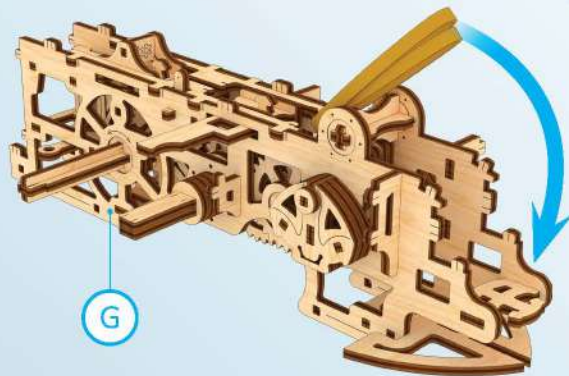

2

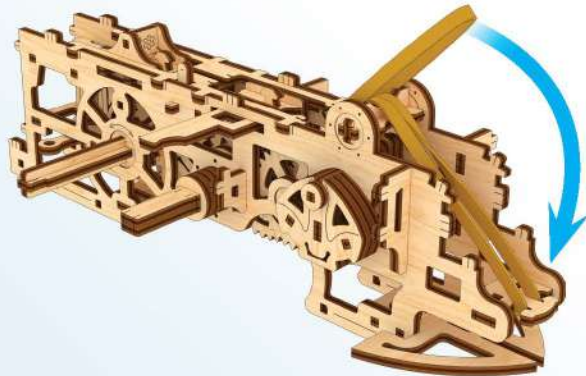

H

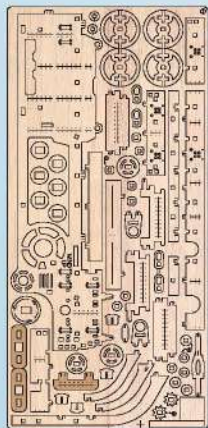
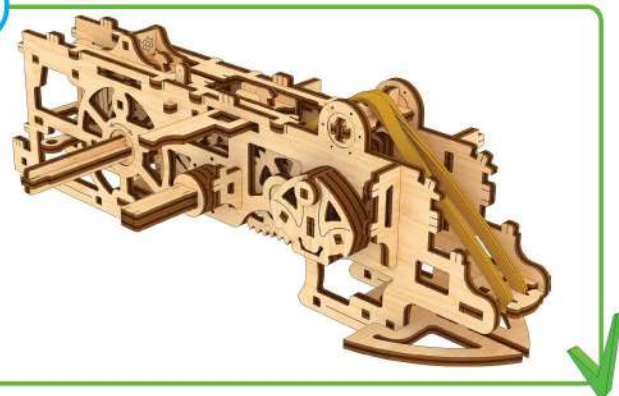

16

3

1

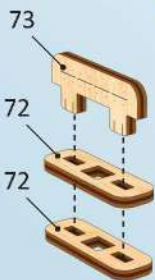

i



1

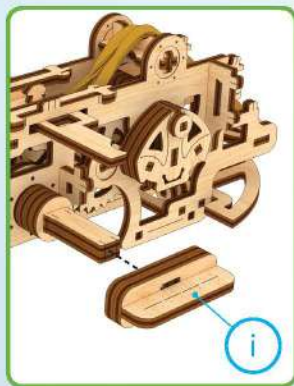

i



2

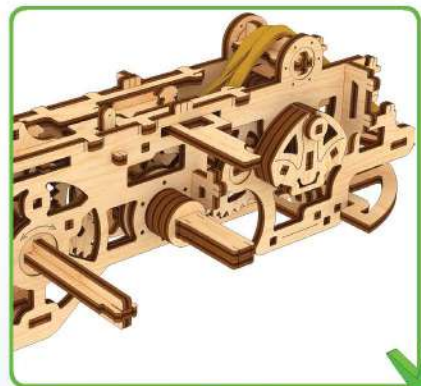
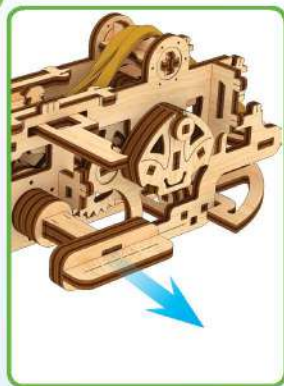

x2

$h = 0.06'' / 1,5 \text{ mm}$
 $D \approx 0.5'' / 12 \text{ mm}$

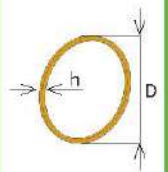

1

1



2



3



4



5



6



7



8

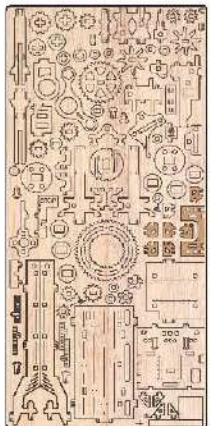

2

1

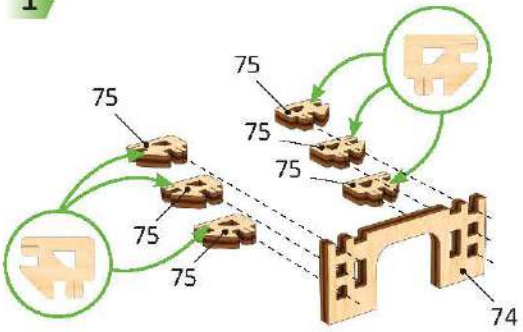

2

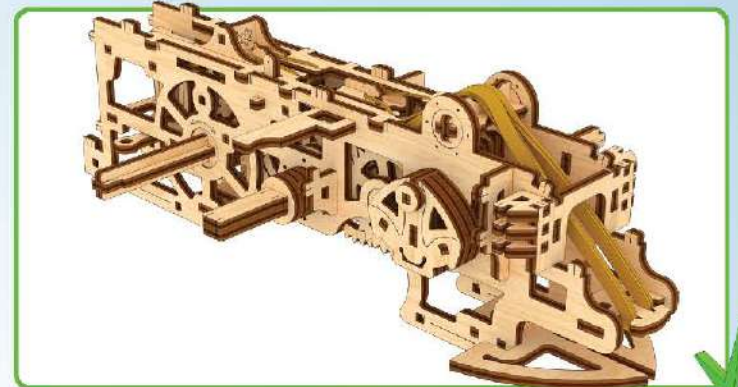
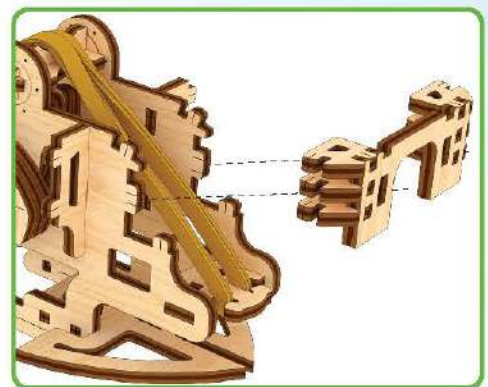

Mechanical models

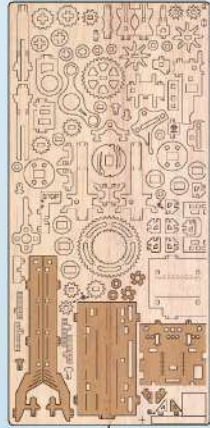

1

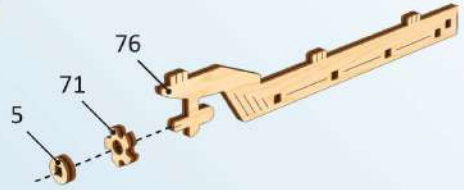

J



x2

2

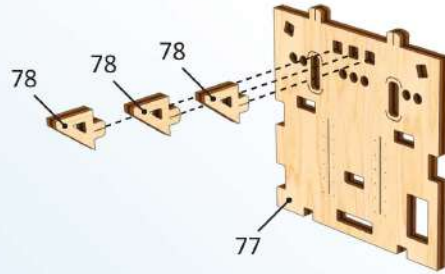

3

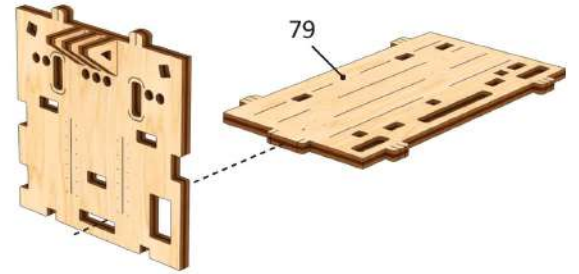

4

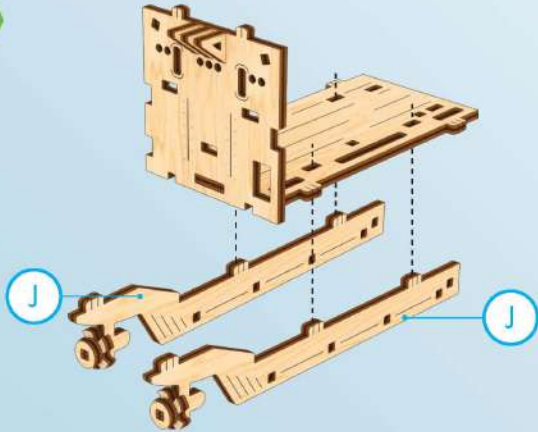

5

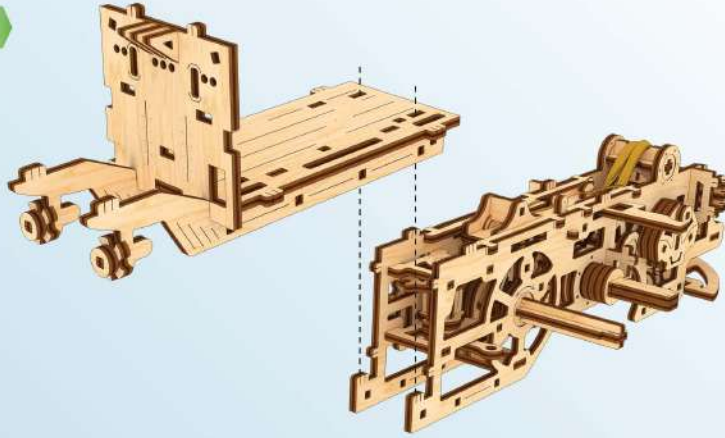

6

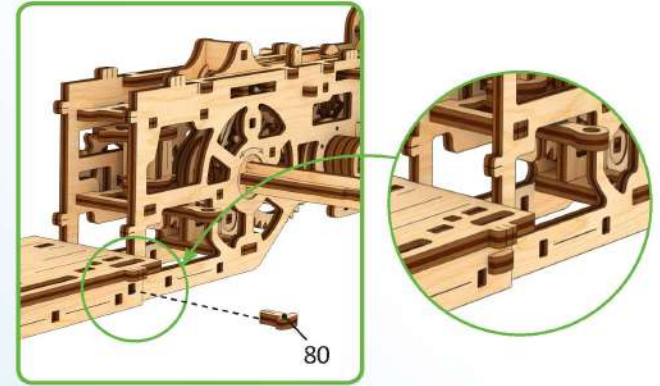

7

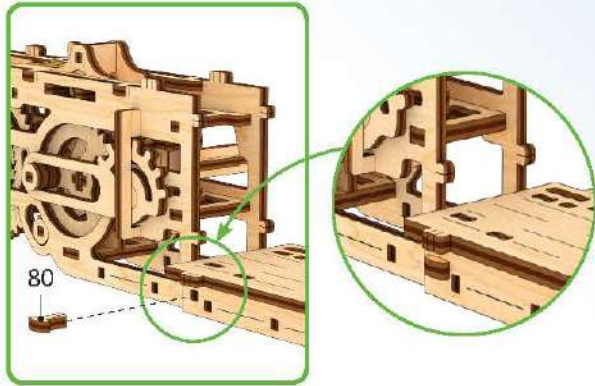

8

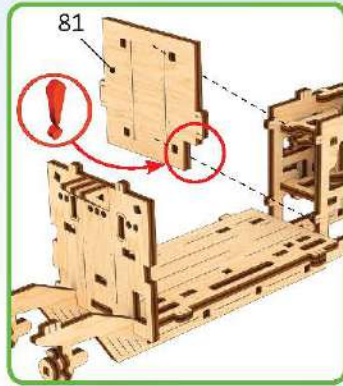

9

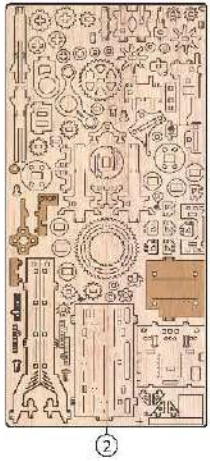
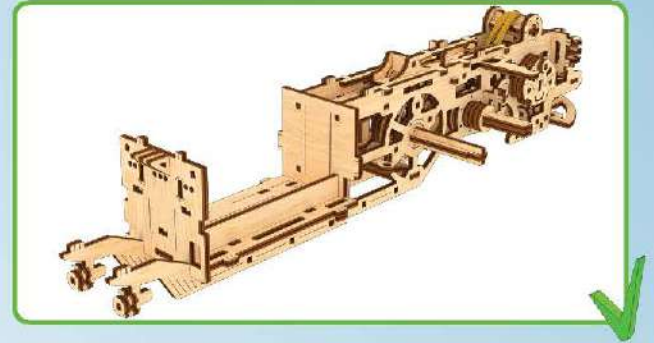
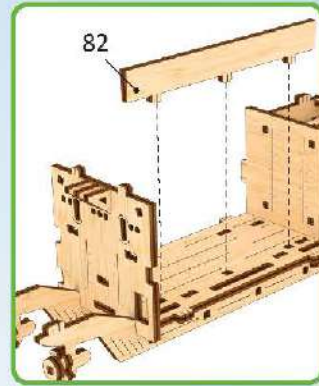

2

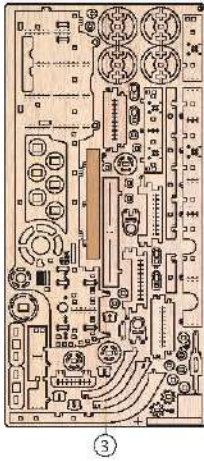

3

1

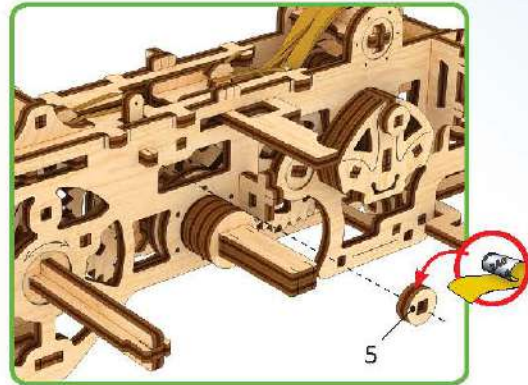

2

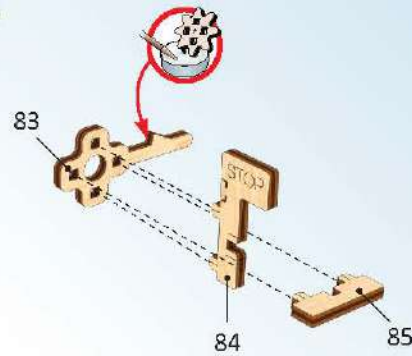

3

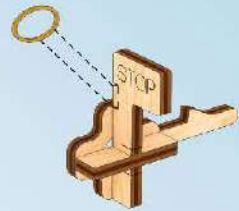
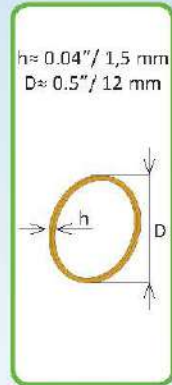

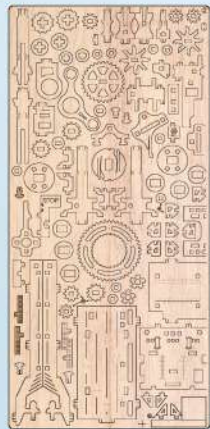

4

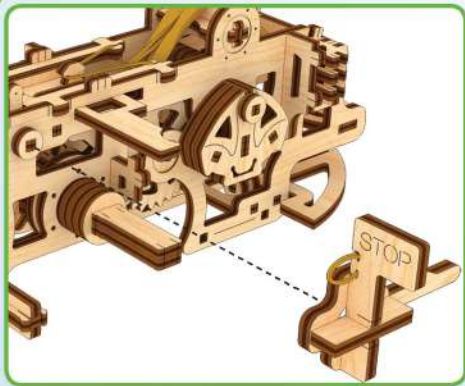

5



6



18

7

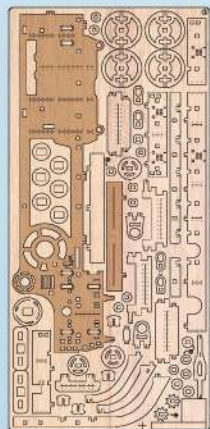
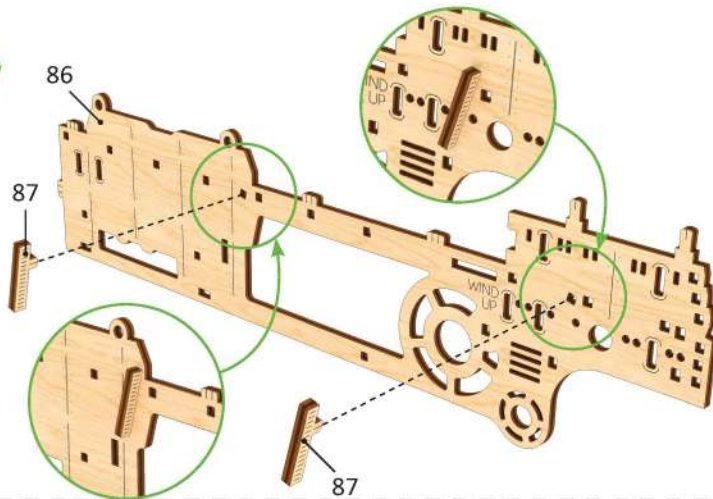

8

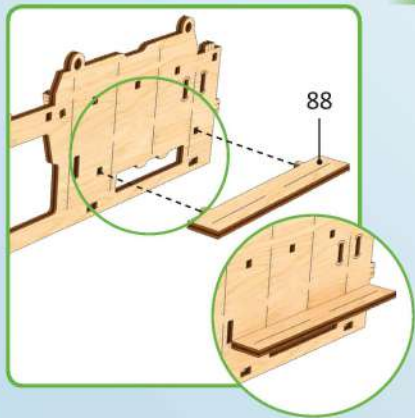

9

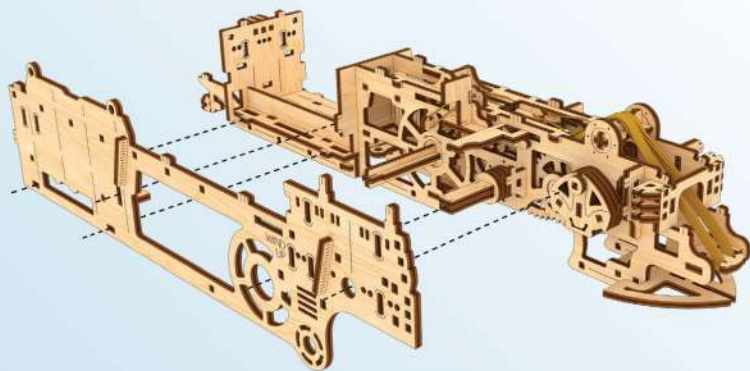

20

3

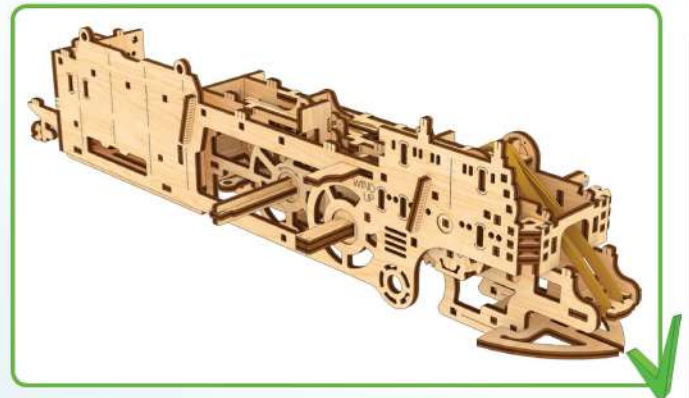

$h \approx 0.2" / 5 \text{ mm}$
 $D \approx 2.4" / 60 \text{ mm}$

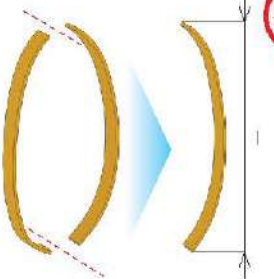
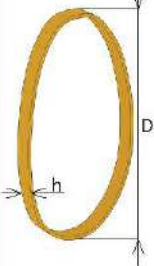

$l \approx 2.2" / 55 \text{ mm}$

x2



1

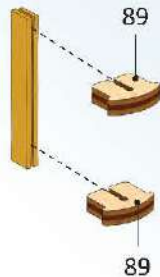

2

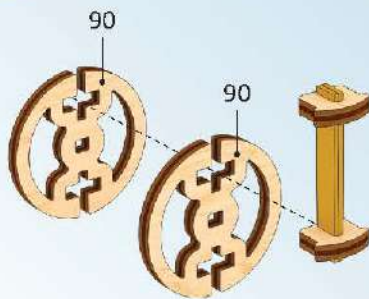

3

1

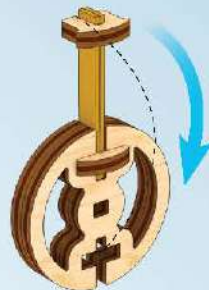

2



3



x2

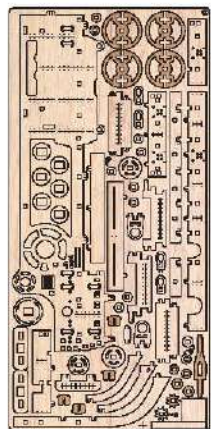

3

4

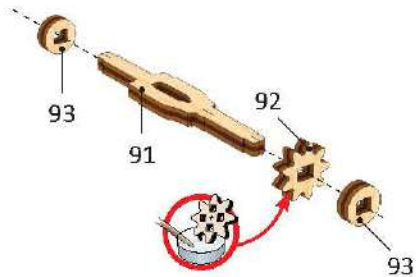

5

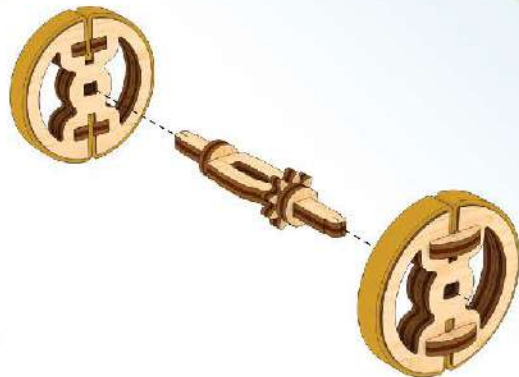

6

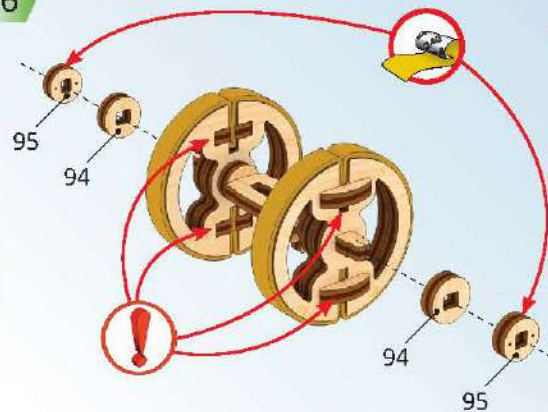

K



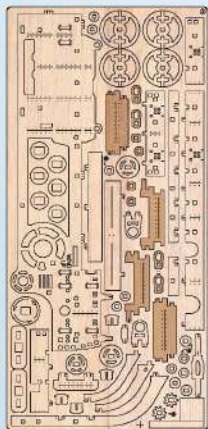

1



2

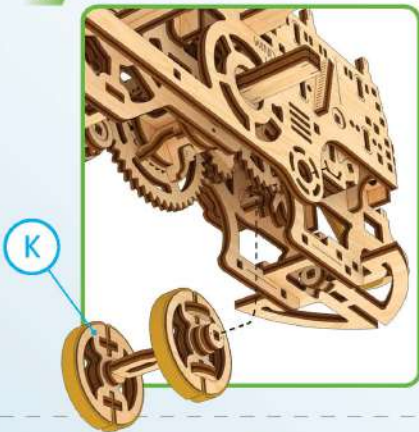

3

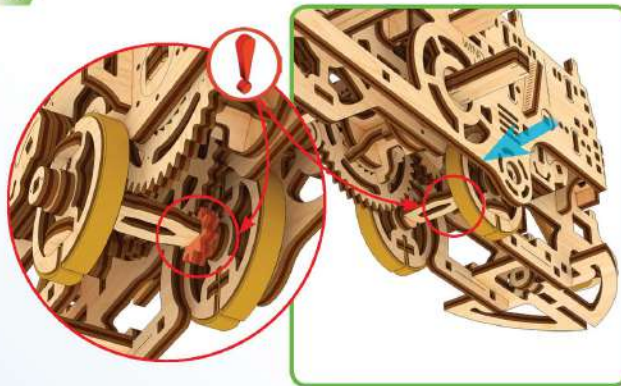

1

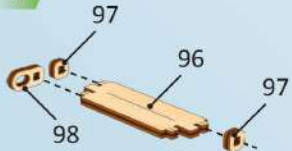

2

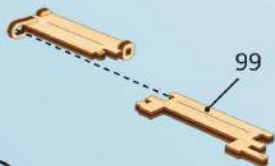

3



4



5

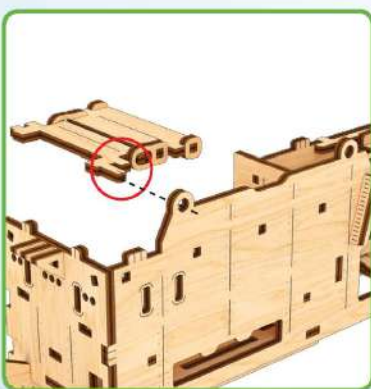

6

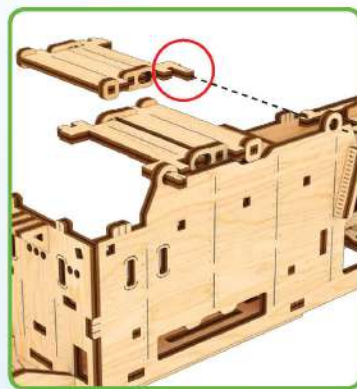

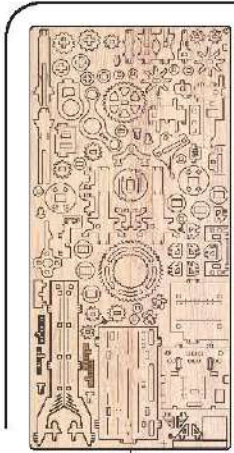

1

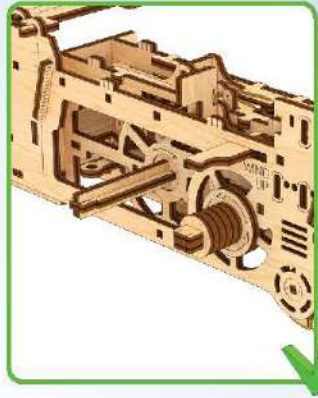
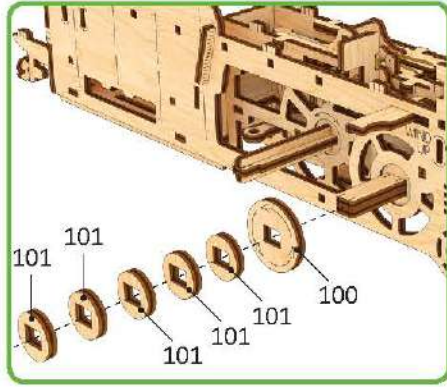

1

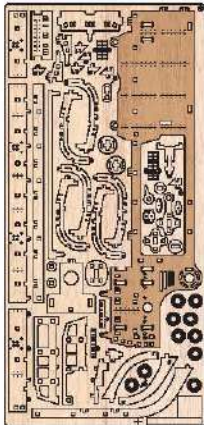
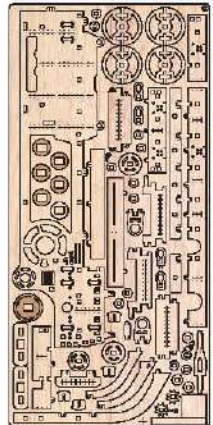
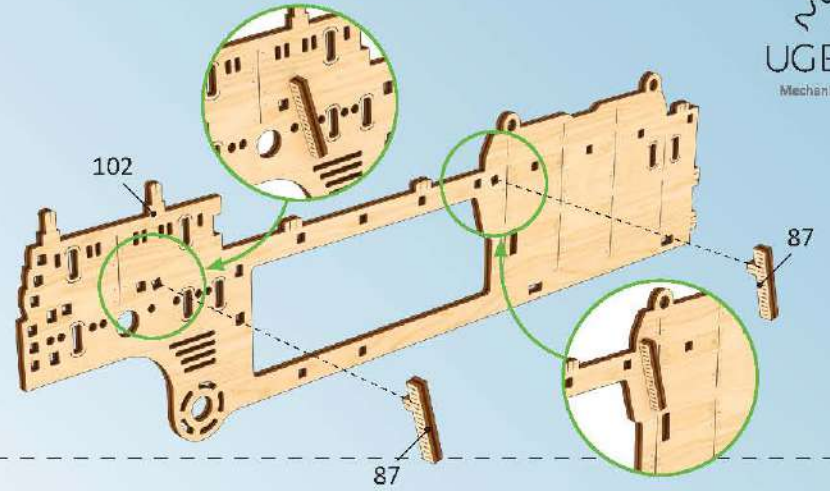

2

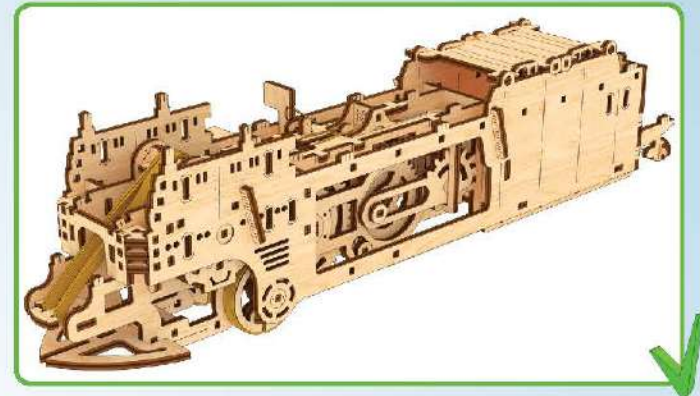
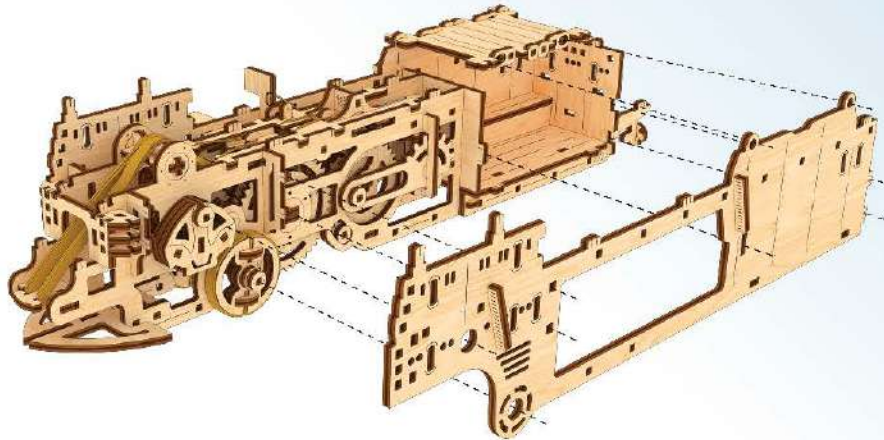

1

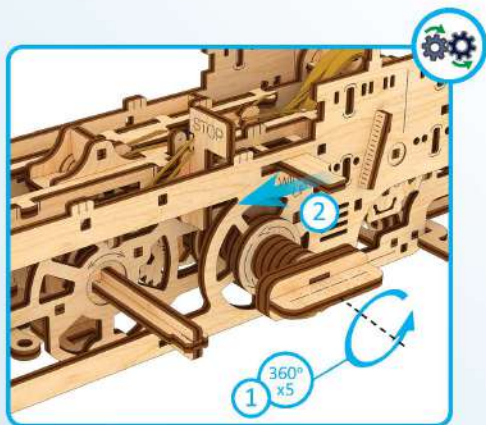
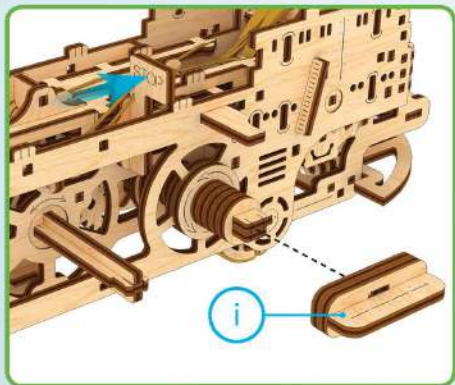

2

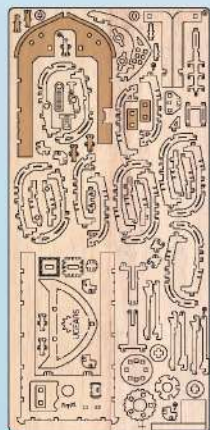
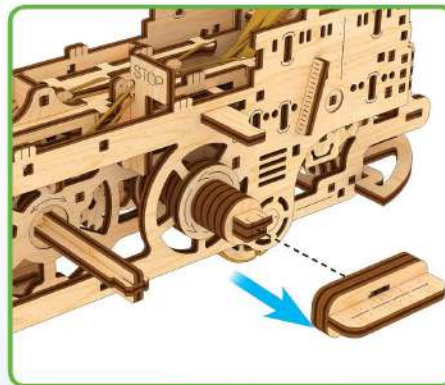

24

5

1

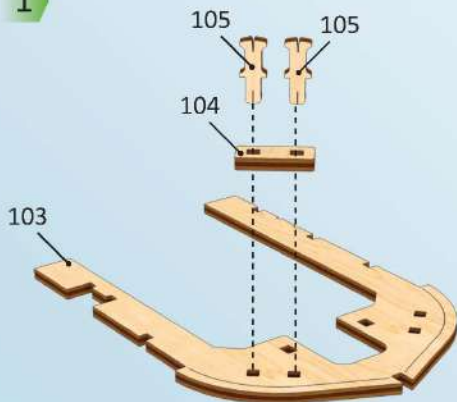

2

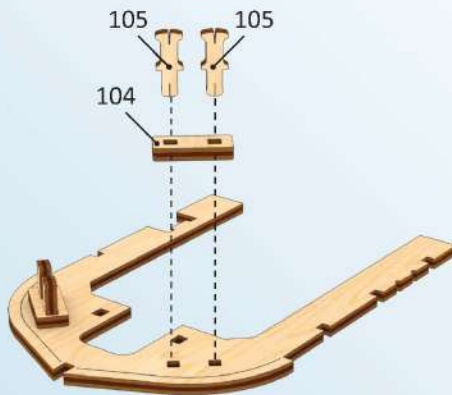

1

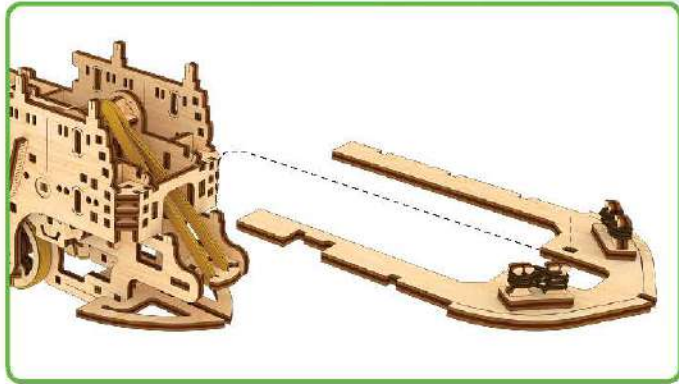

2

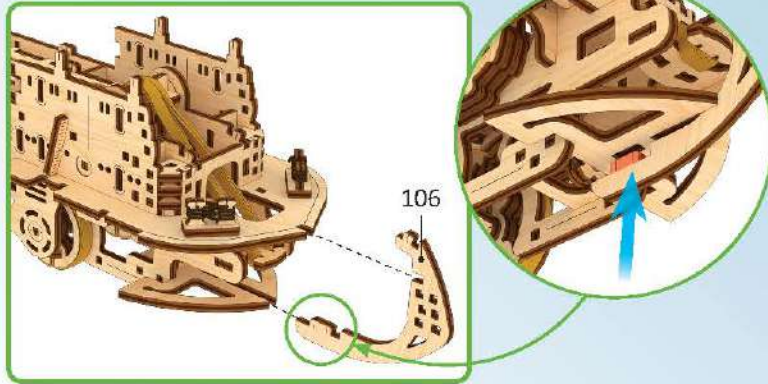

3

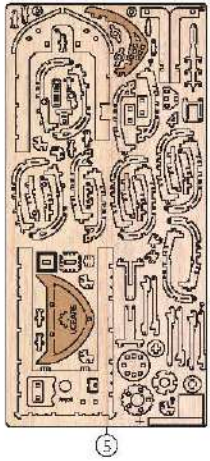
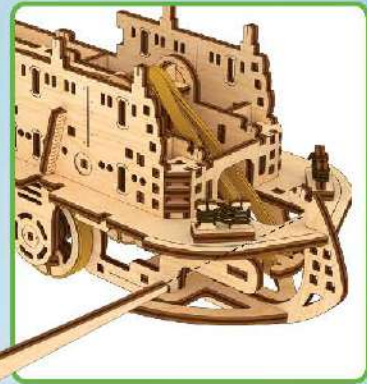

4

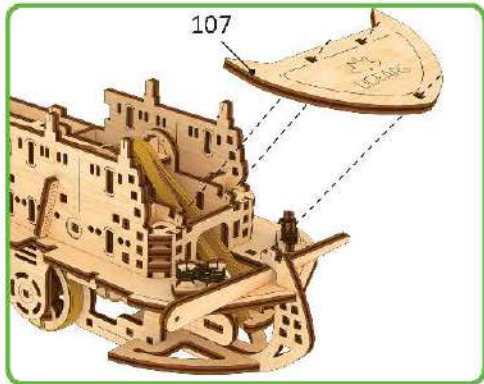

5

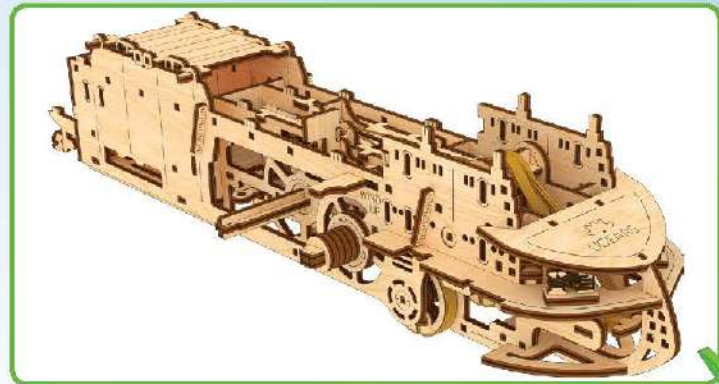
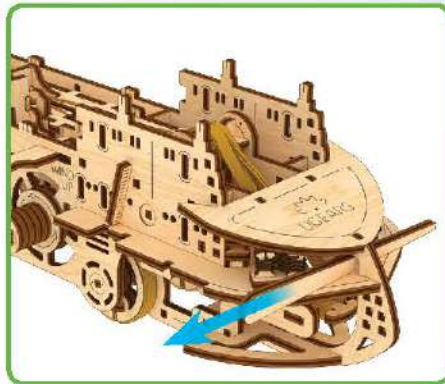

Mechanical models

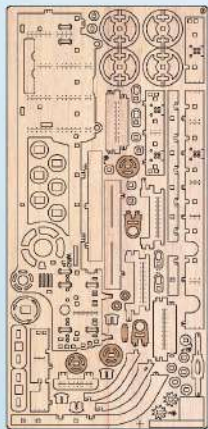

3

1

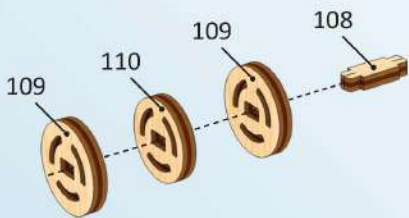

2

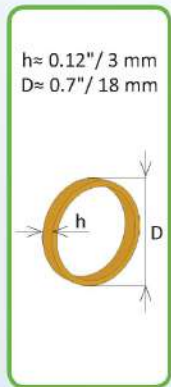

3

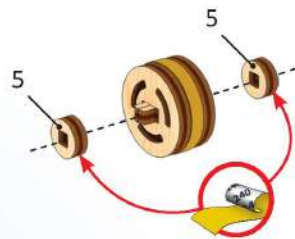
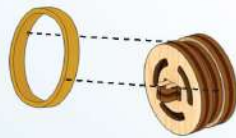

4

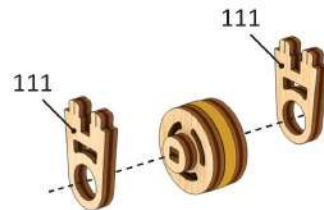

5

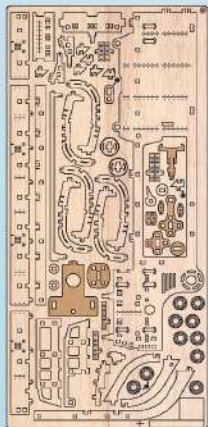
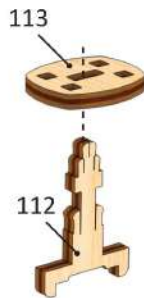

26

4

6



7

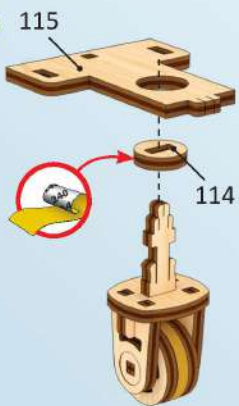

8

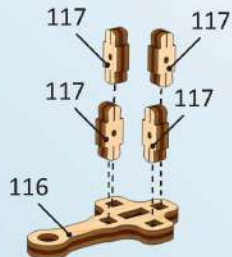

9

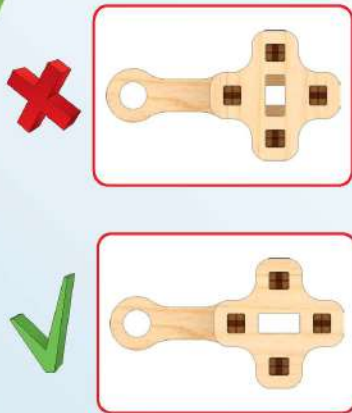

10

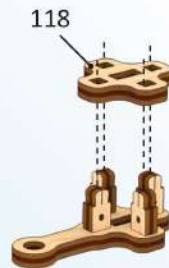

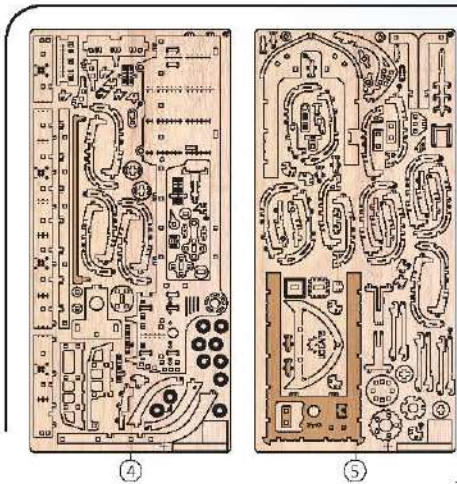

1

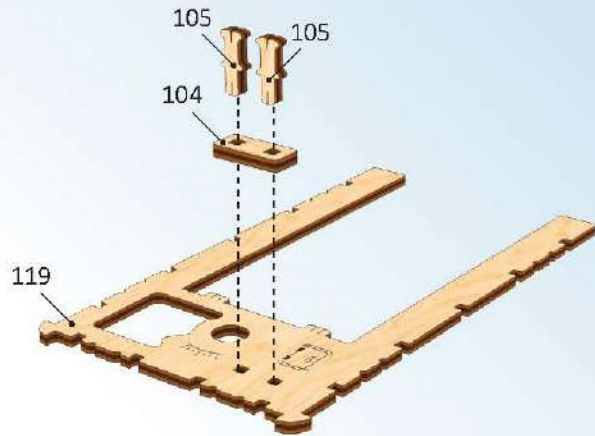

L

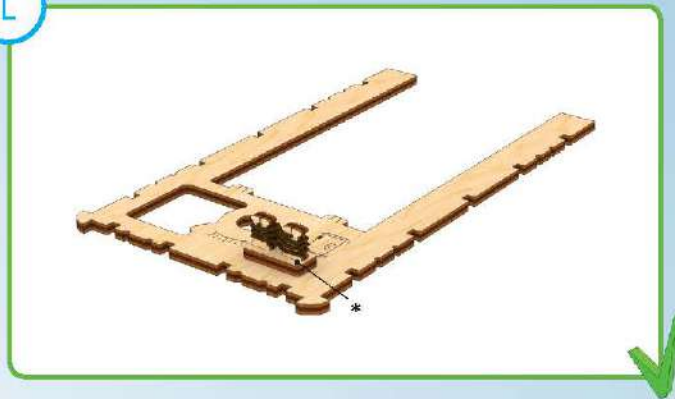

1

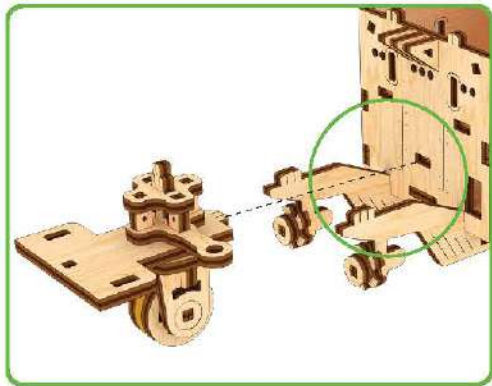

2

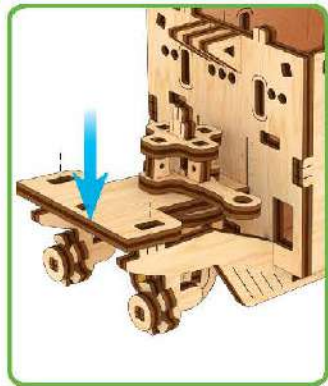

3

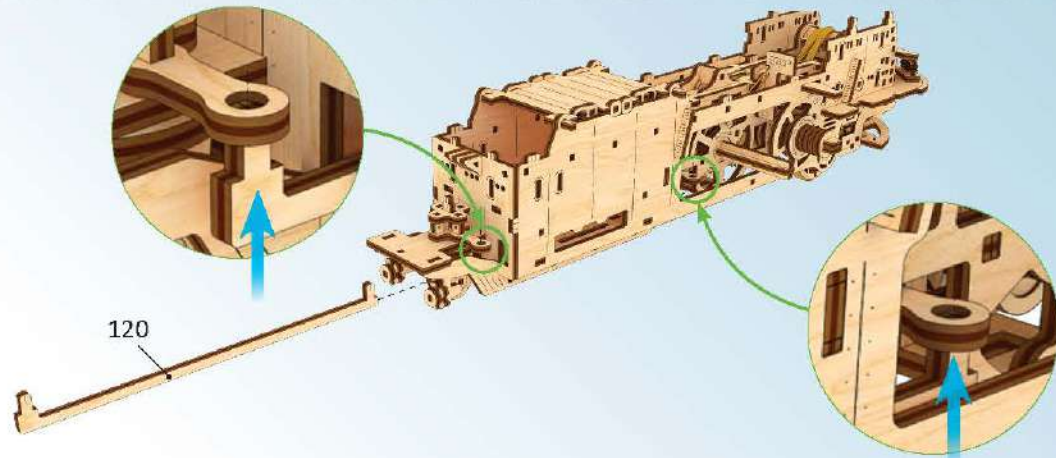

Mechanical models

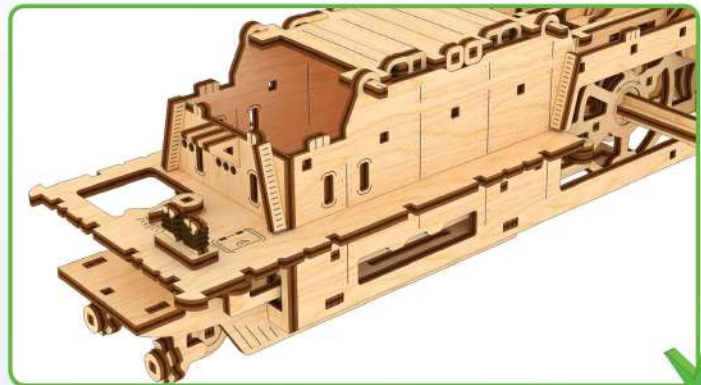
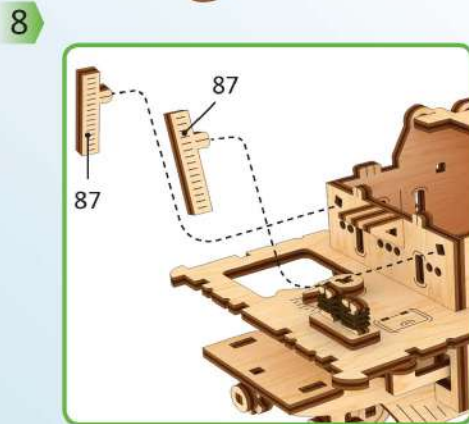
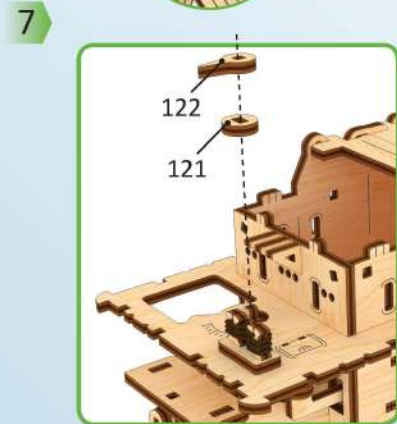
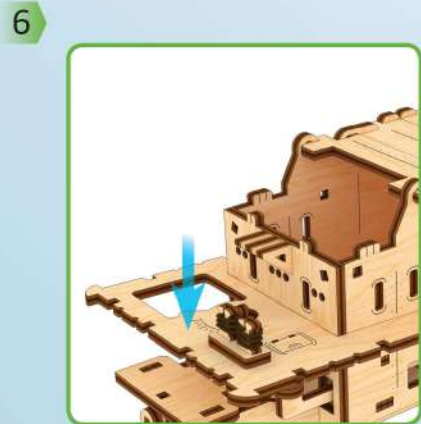
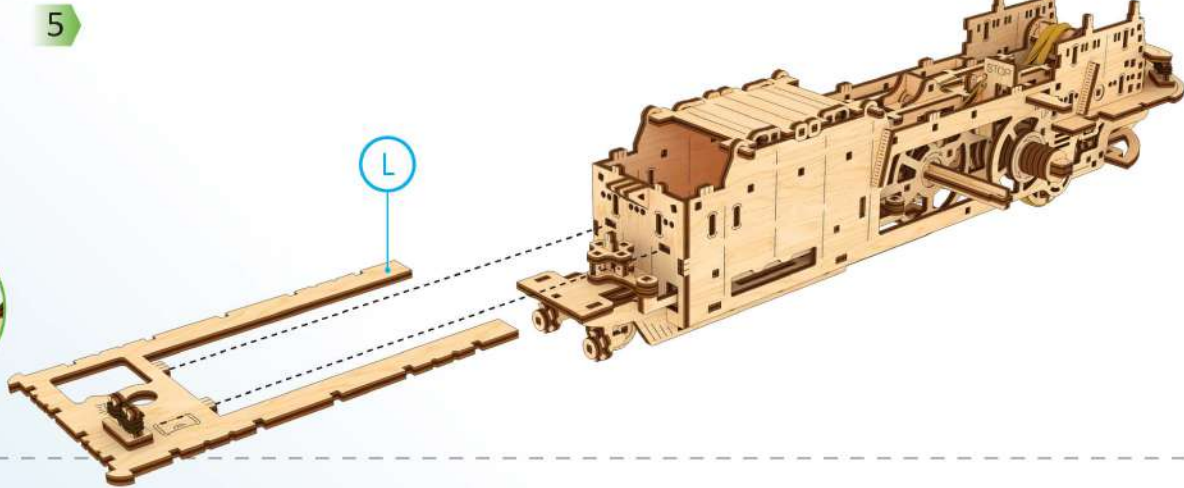
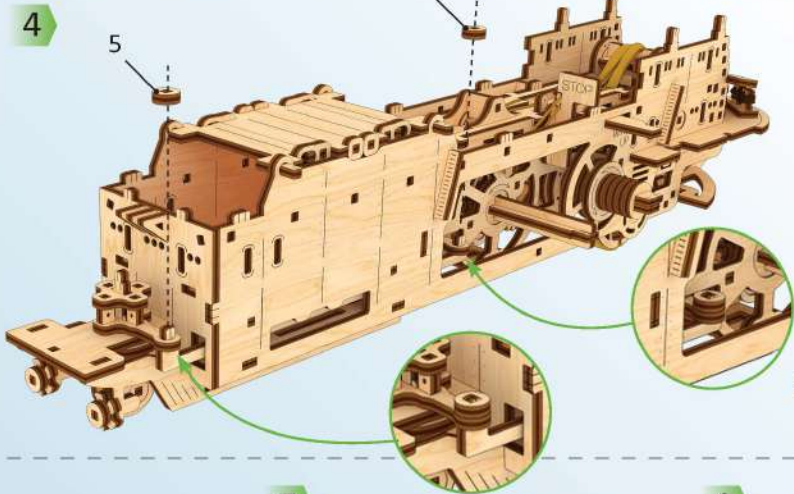
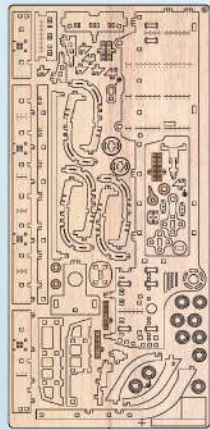

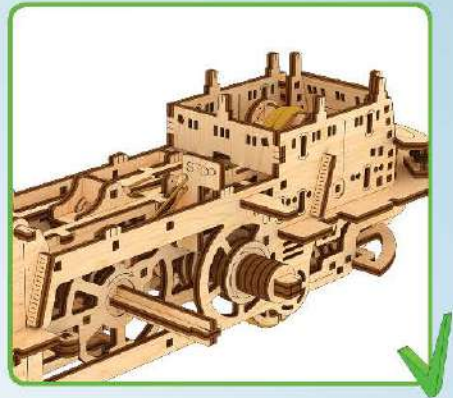
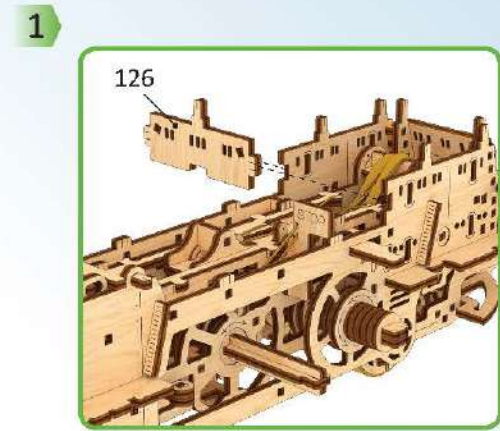
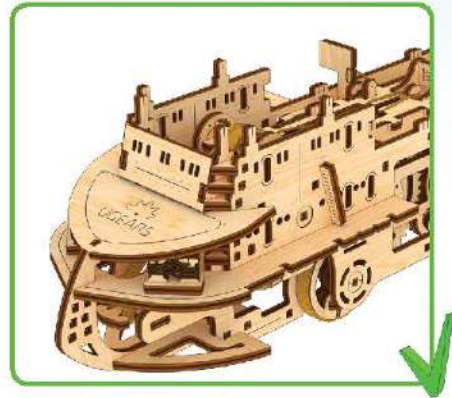
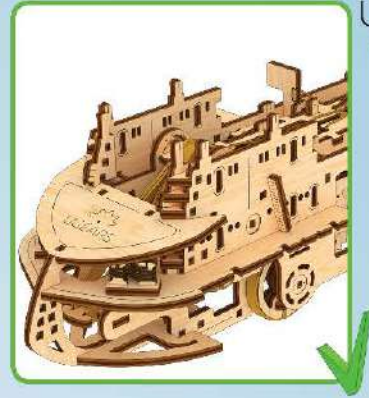
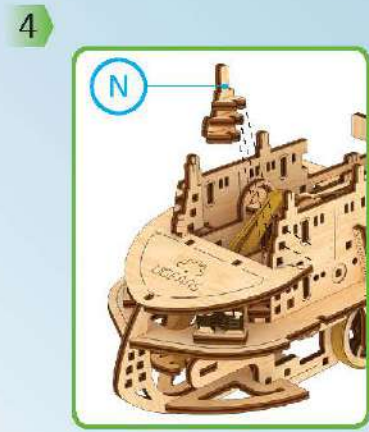
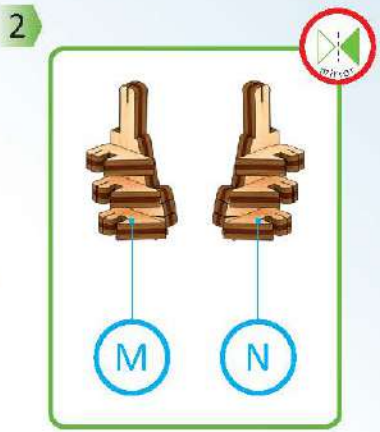
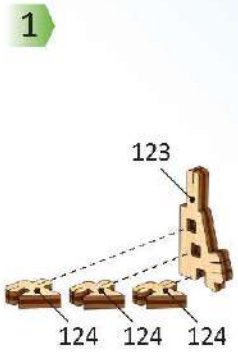
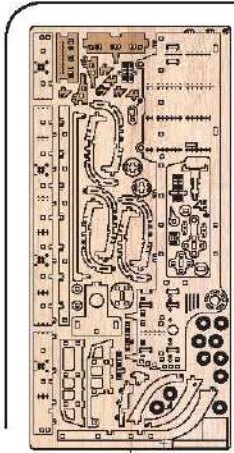

Mechanical models

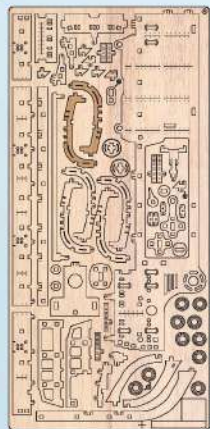

4

1

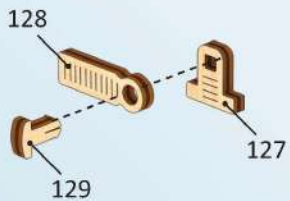

2

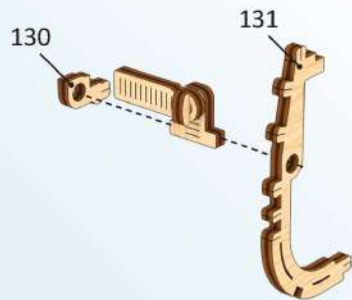

3

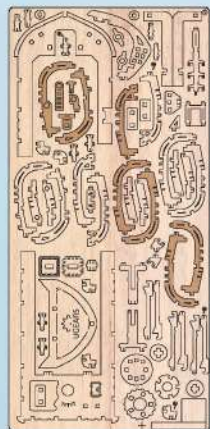
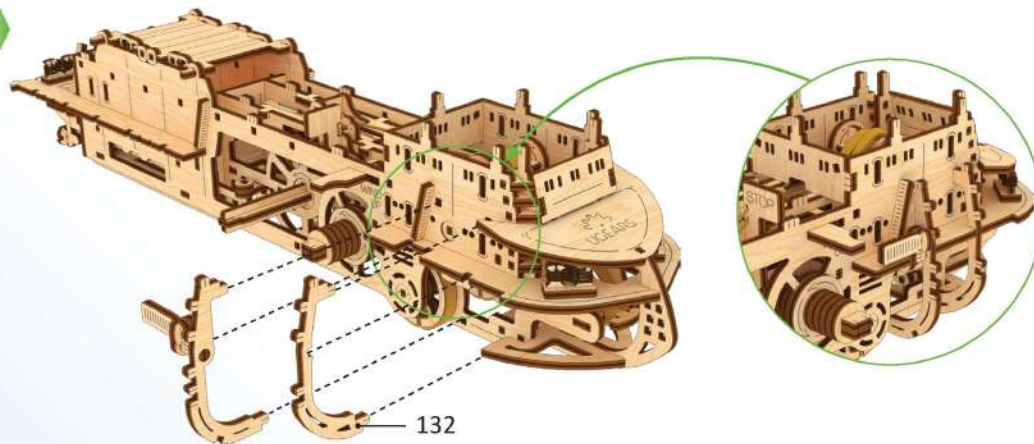

30

5

4

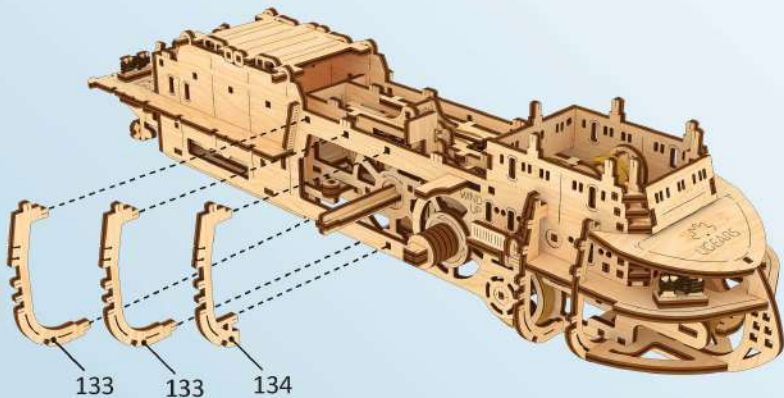

5

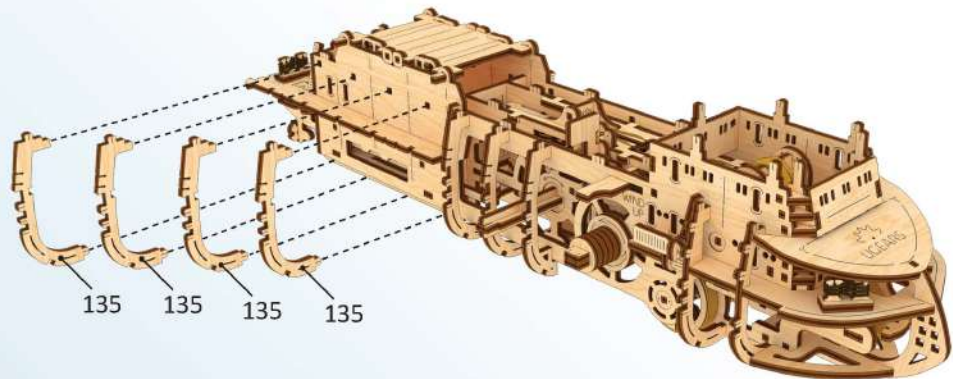

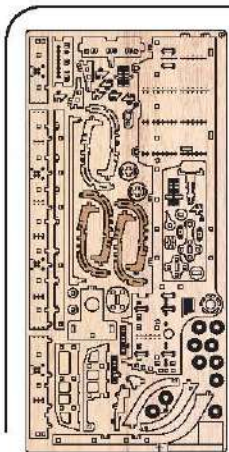

4

6

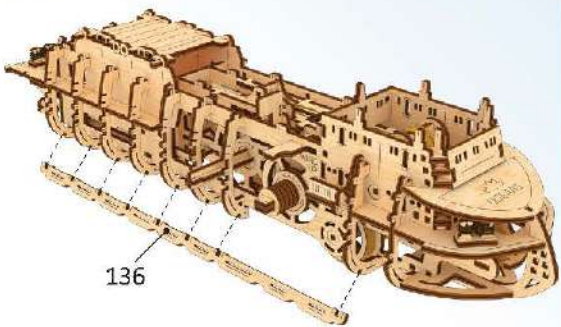

136

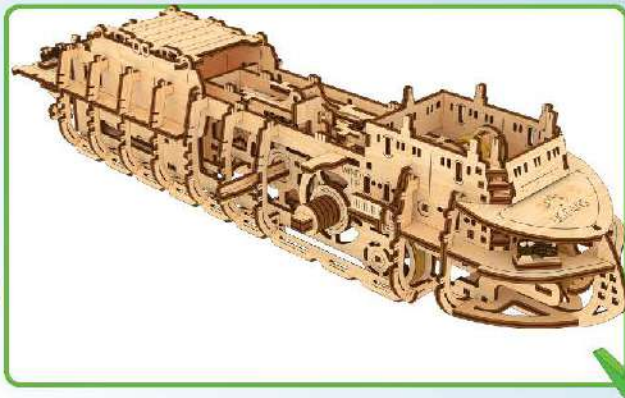

1

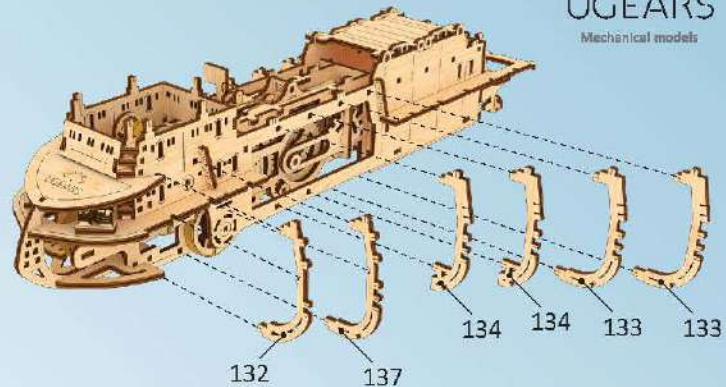

132

137

134

134

133

133

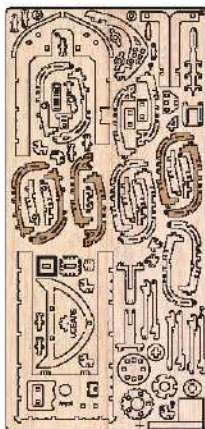

5

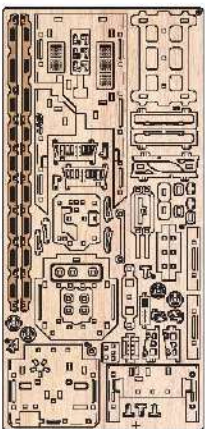

6

2

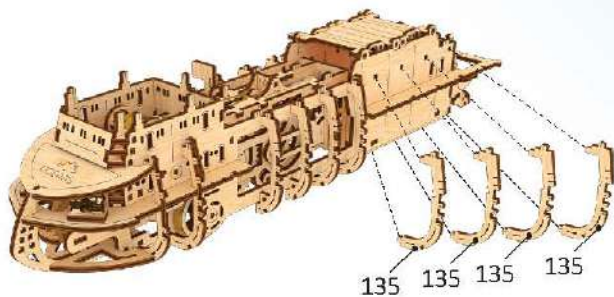

135

135

135

135

3

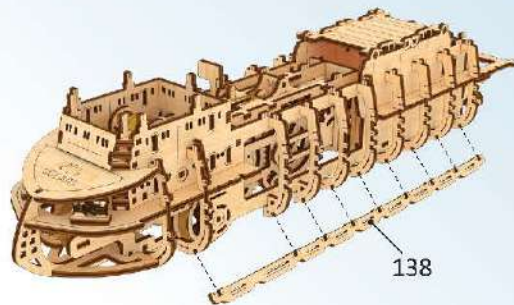

138

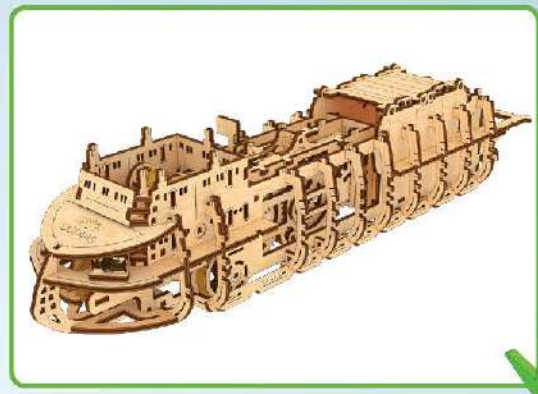

31

Mechanical models

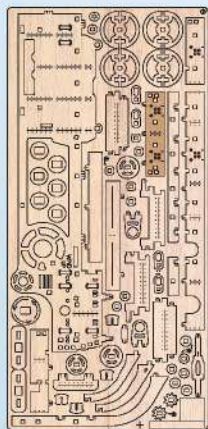

3

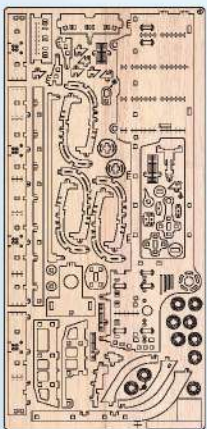

4

1

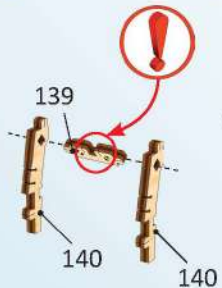

2

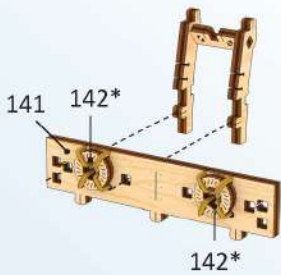

3

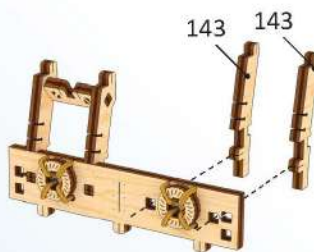

4

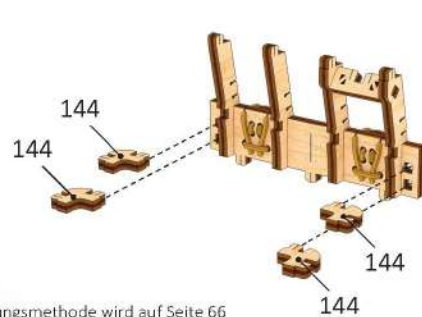

* **ENG** The fastening method is described on page 66. **UKR** Спосіб зав'язування вказаний на стр. 66. **DEU** Die Befestigungsmethode wird auf Seite 66 beschrieben. **FRA** Vous trouverez une description de la méthode d'union à la page 66. **POL** Sposób wiązania jest opisany na stronie 66-tej. **SPA** El método de sujeción se describe en la página 66. **ITA** Il metodo di fissaggio è descritto a pagina 66. **RUS** Способ завязывания указан на стр.66. **JAP** 締め方は 66 ページに記載されています。 **KOR** 고정 방법은 66페이지에 설명되어 있습니다. **CHI** 固定方法请参见第66页

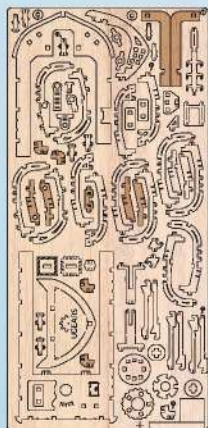

32

5

5

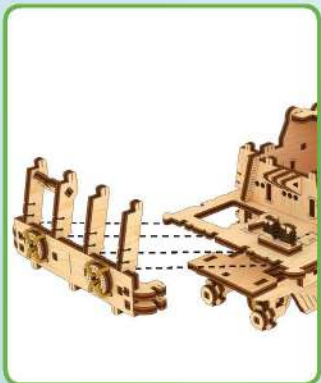

6

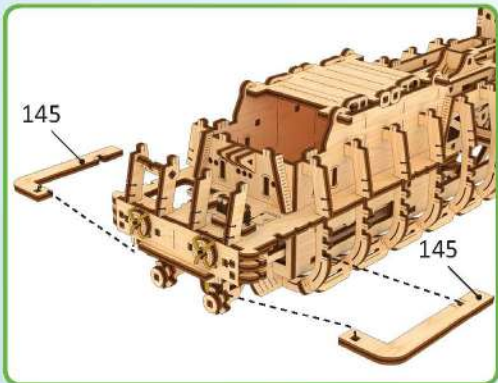

7

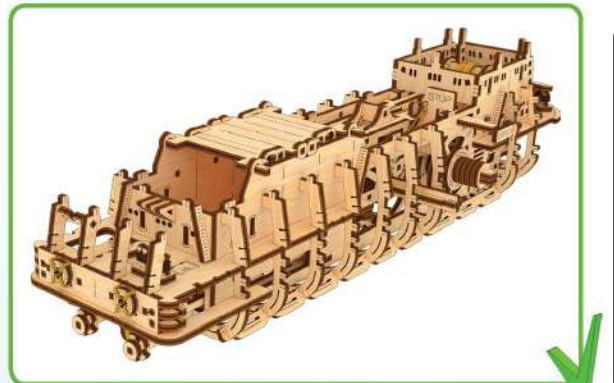
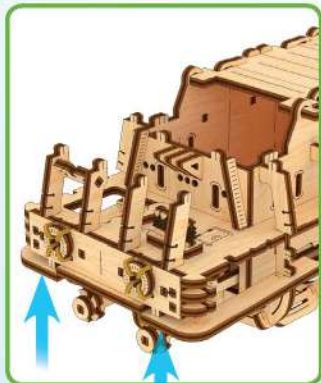

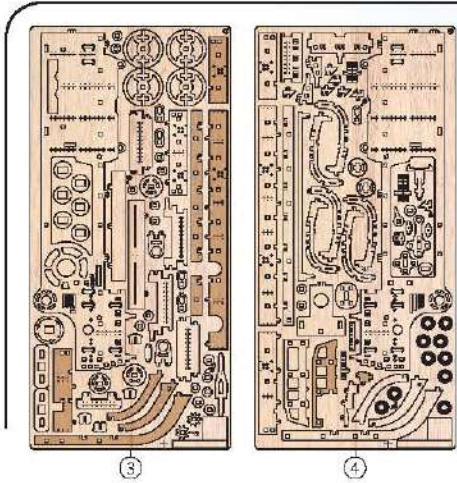

1

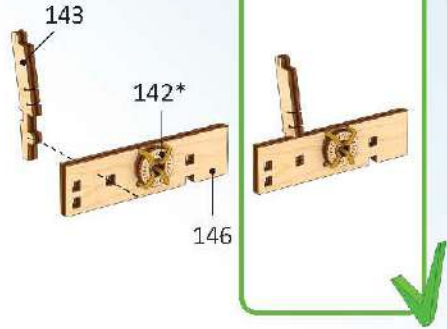

1

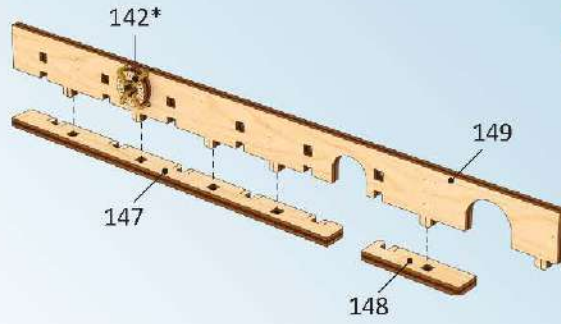

o2

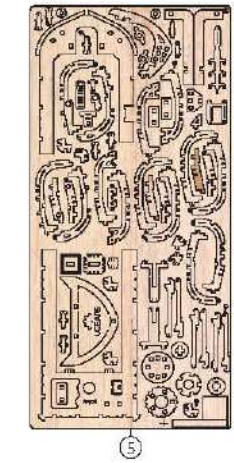
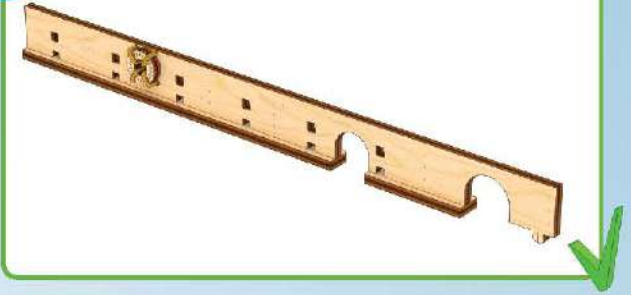

1

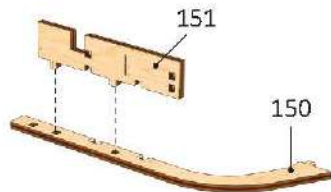

2

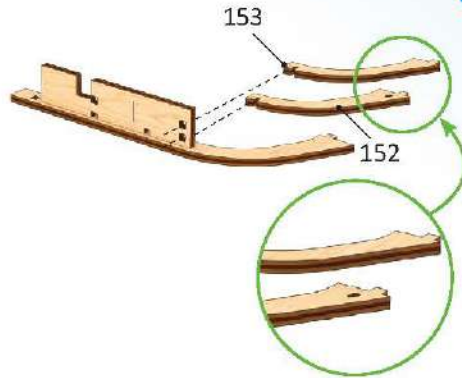

o3



1

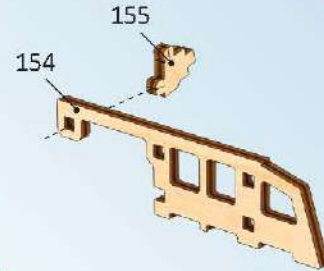

o4

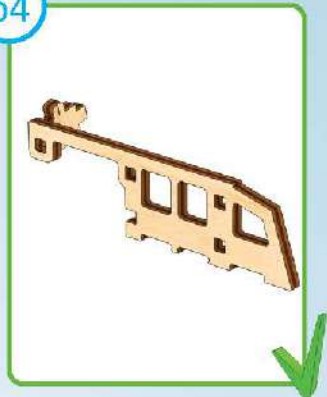

Mechanical models

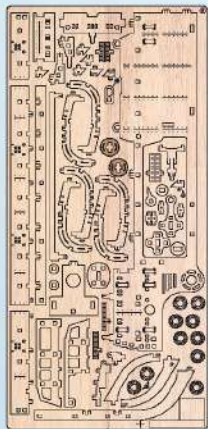

4

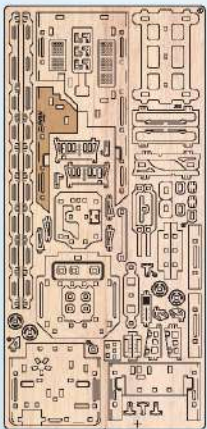

6

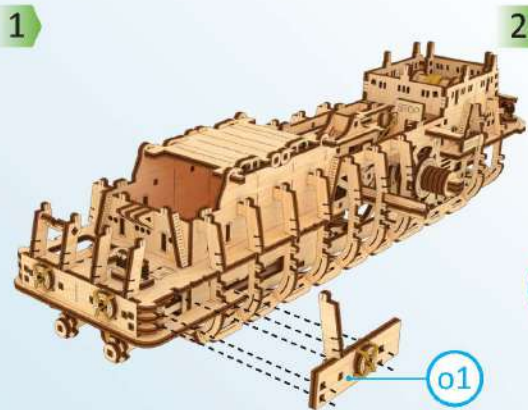

1

2

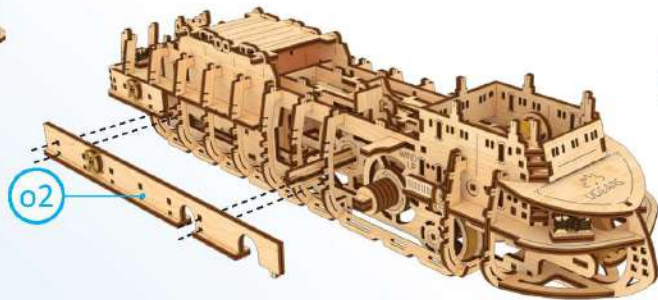

02

01

3

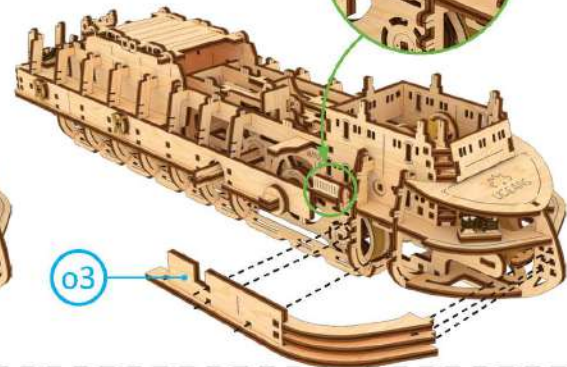

03

4

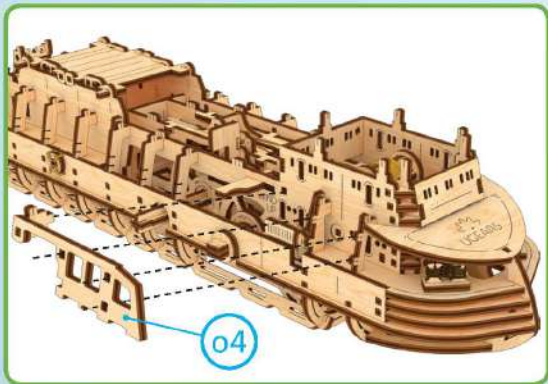

04

5

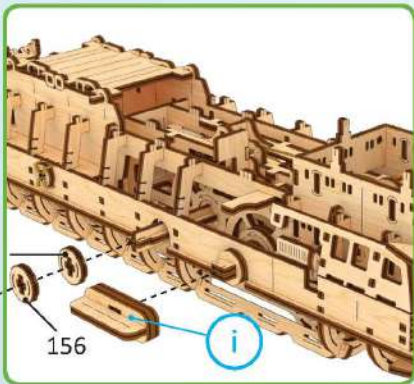

156

156

i

6

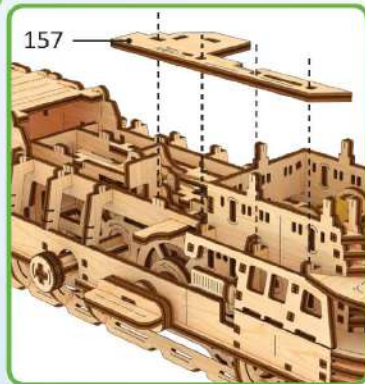

157

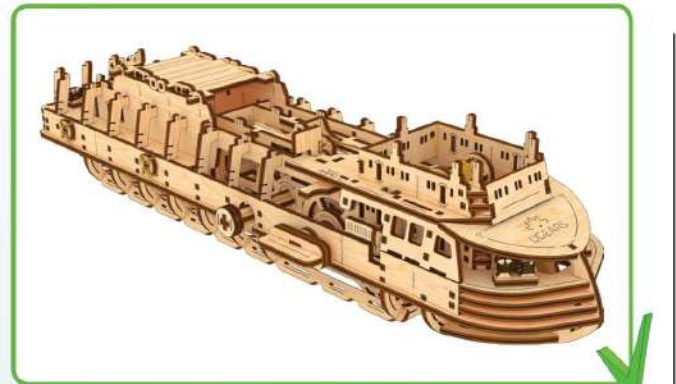

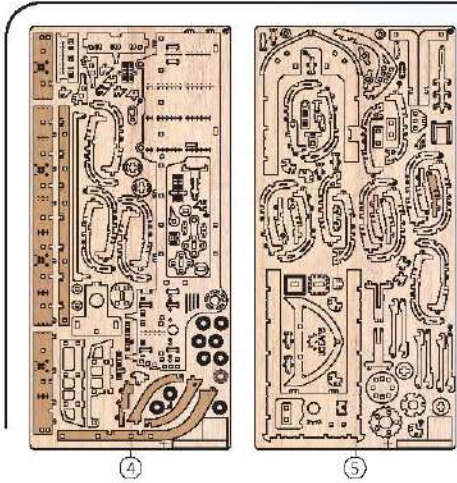

1



p1



1

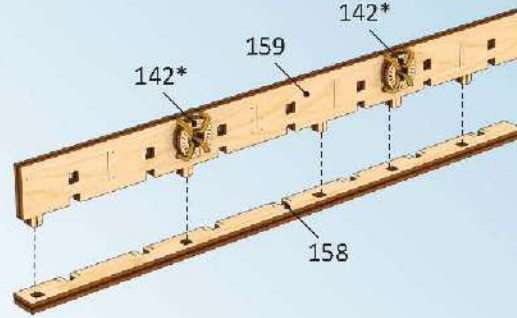

p2

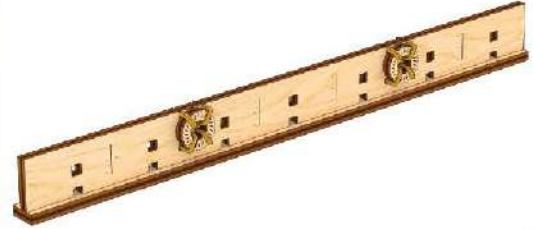

1

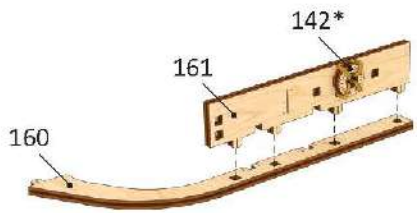

2

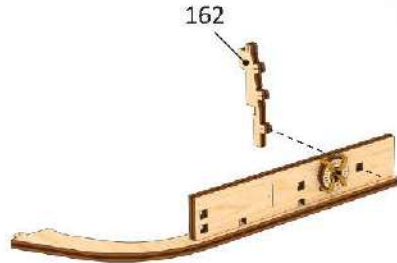

3

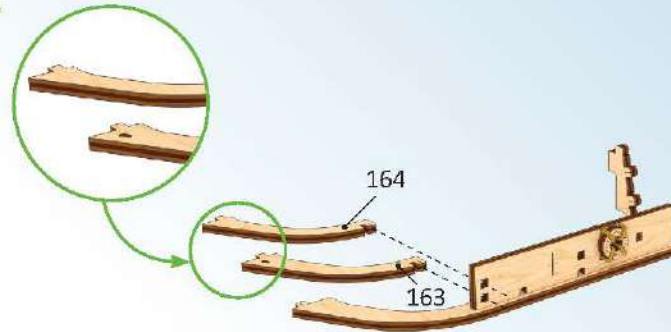

p3

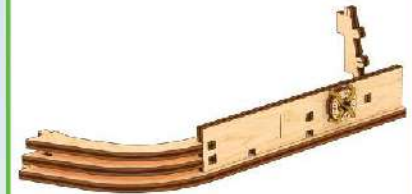

Mechanical models

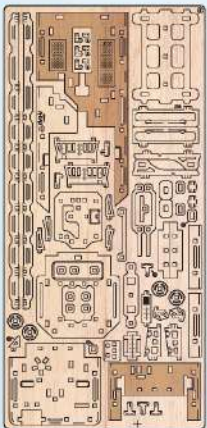
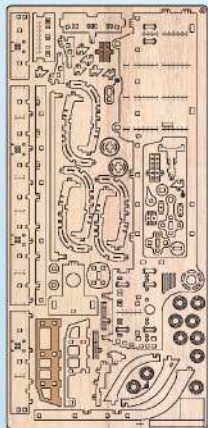

1

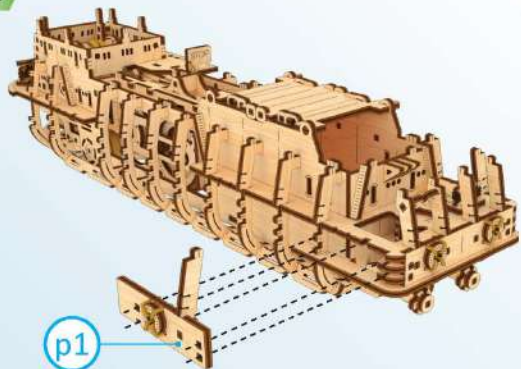

2

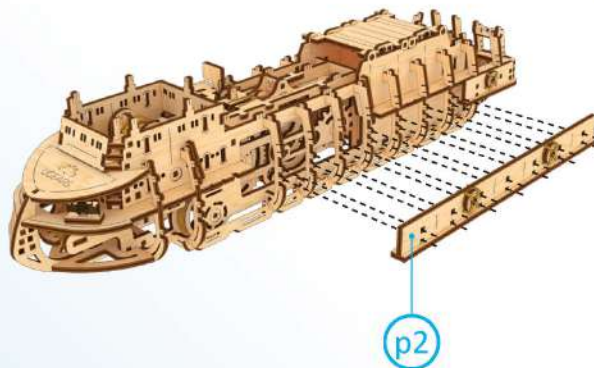

3

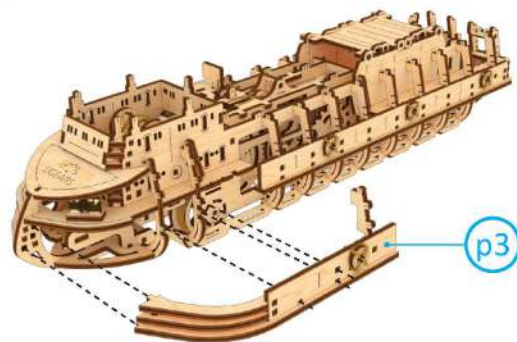

4

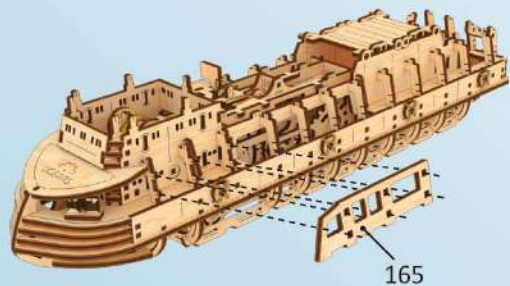

5

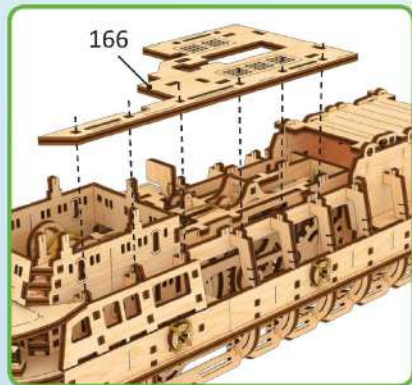

6

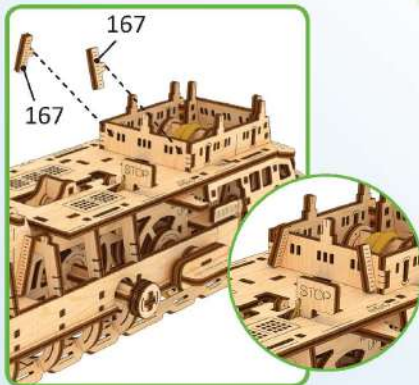

7

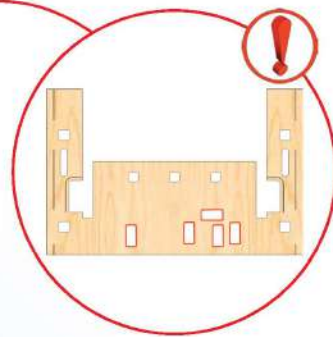
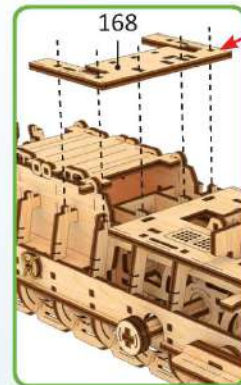

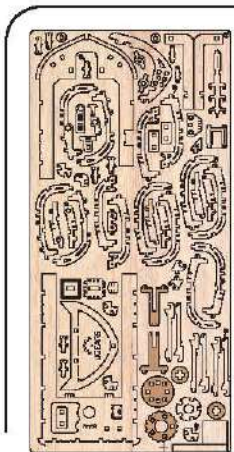

5

8

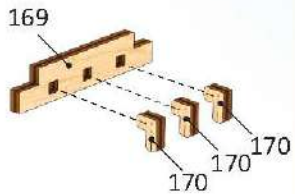

9



10

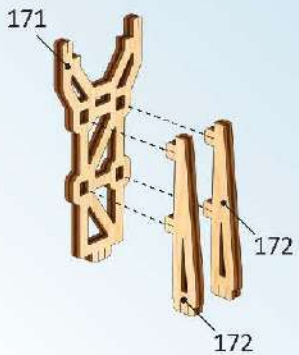

11

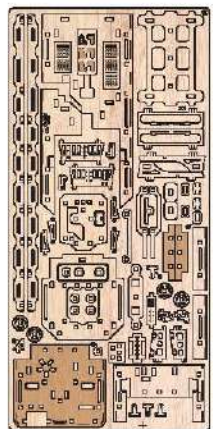
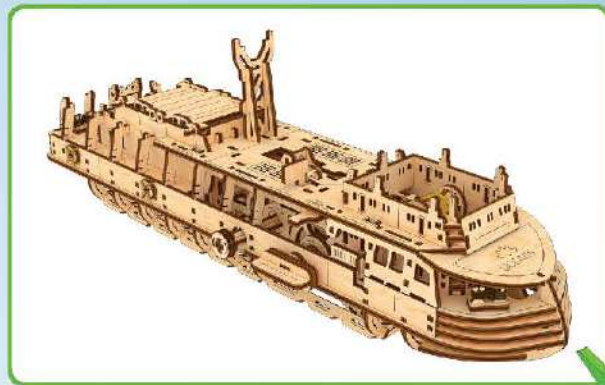
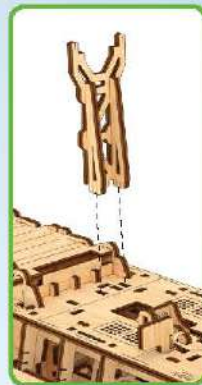

6

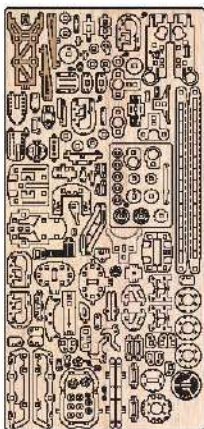

7

1

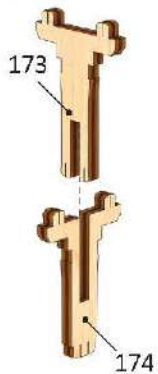

2

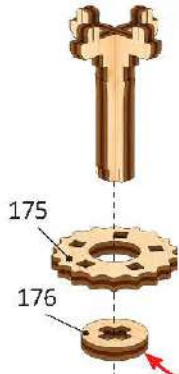

3



q1



1

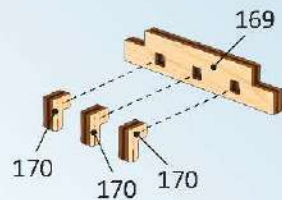

2

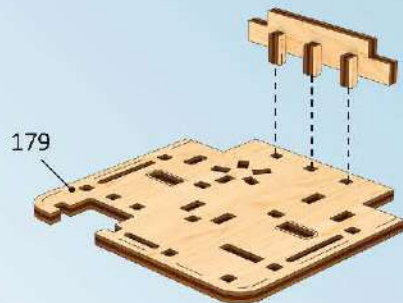

6

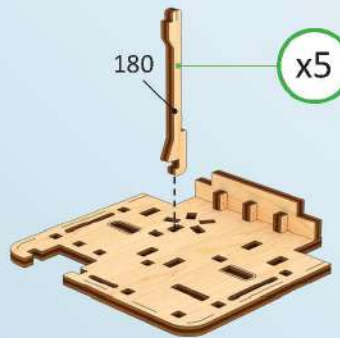

7

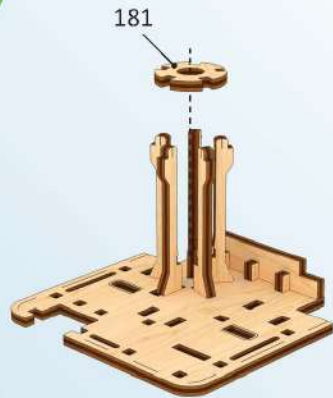

8



9

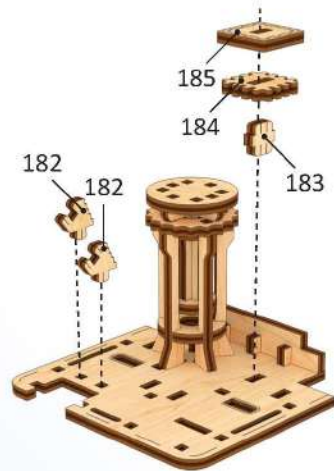

q2

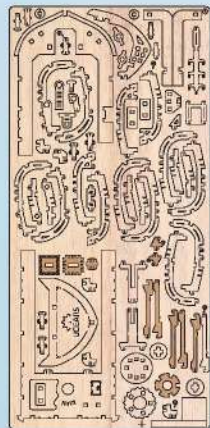

38

5

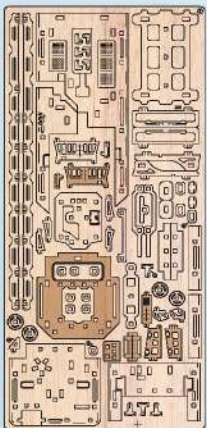

6

1

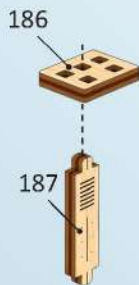

2

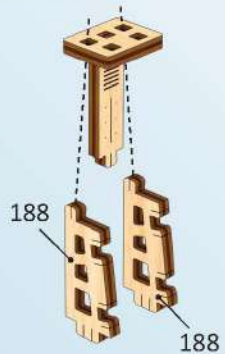

3

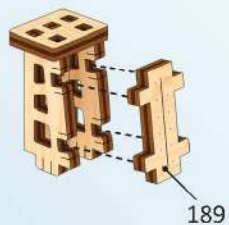

q3



1



2

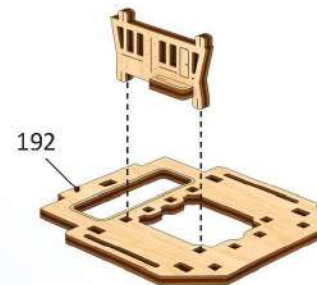

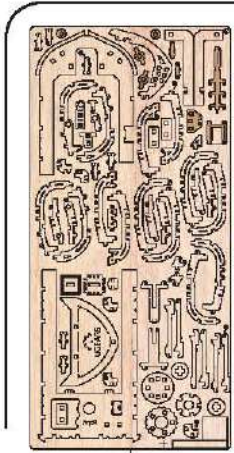

5

3

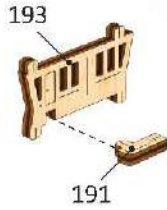

4

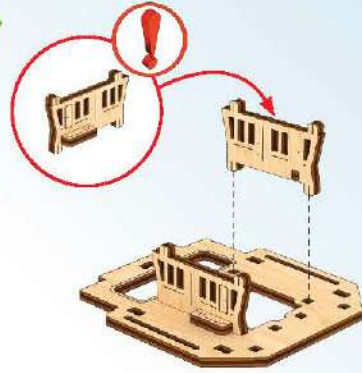

5

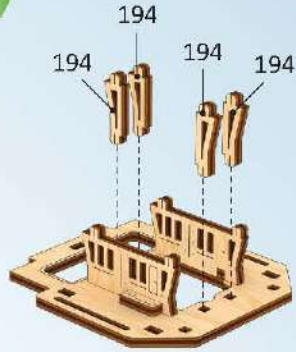

6

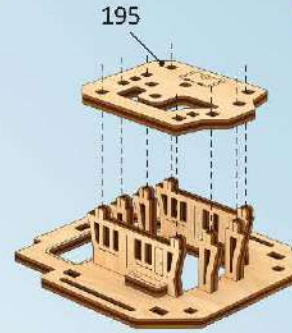

q4

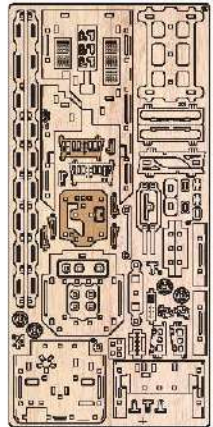

6

1

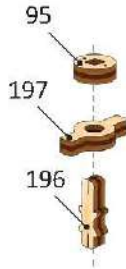

q5

x2



1

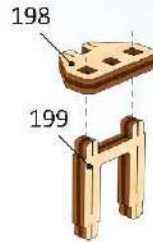

2

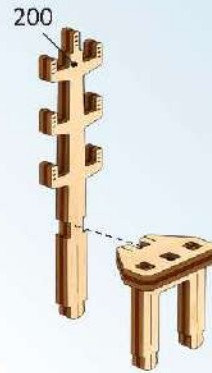

3

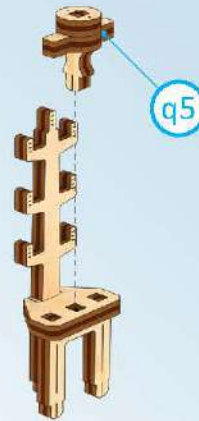

q5

q6



Mechanical models

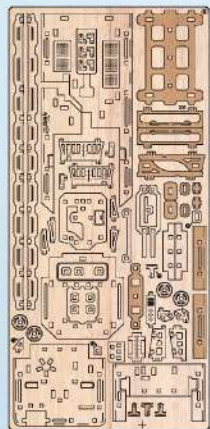

1

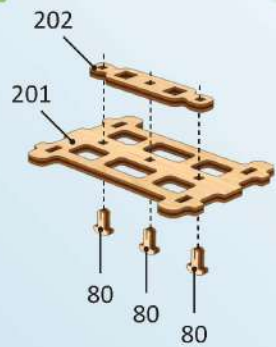

2

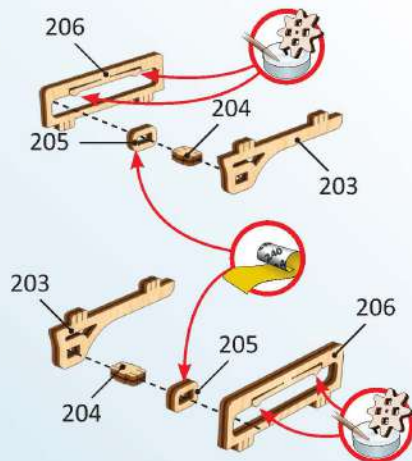

3

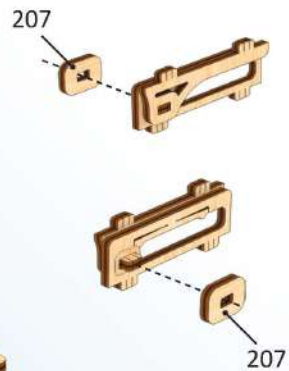

4

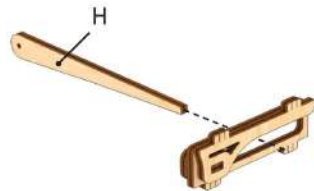

5

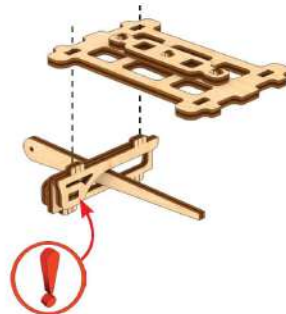

6

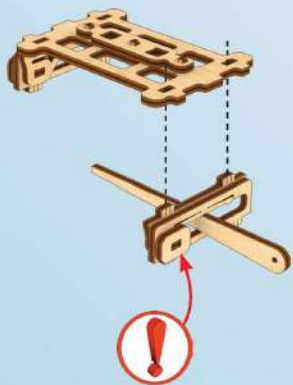

q7



1

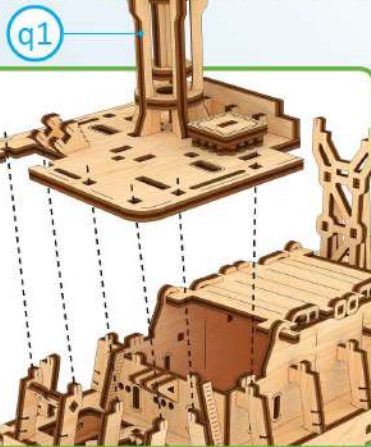

2

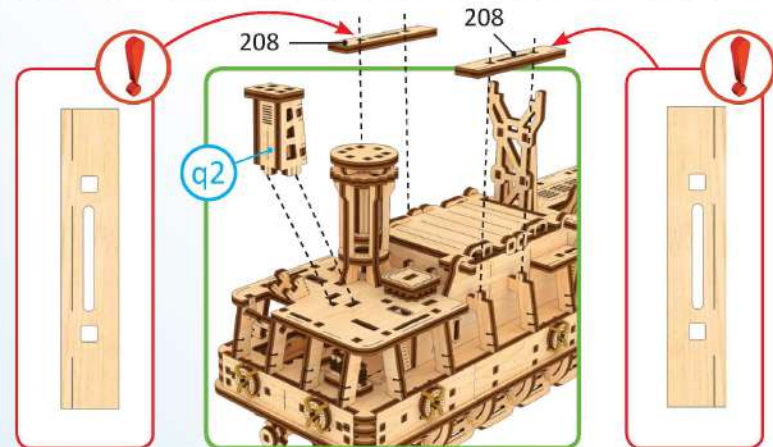

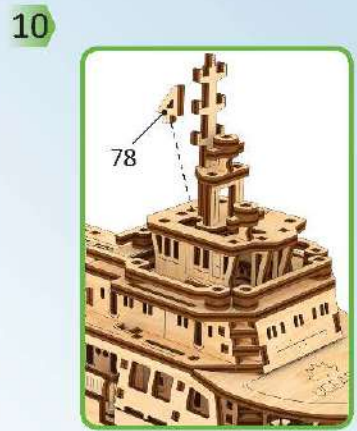
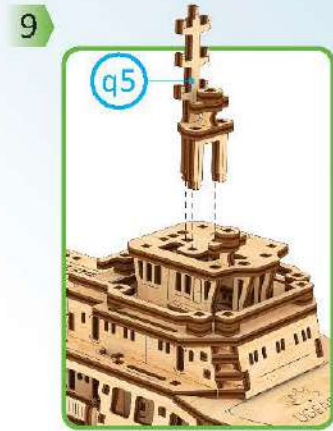
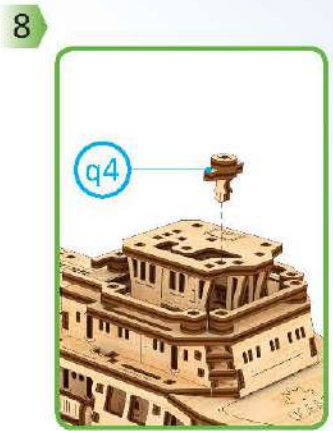
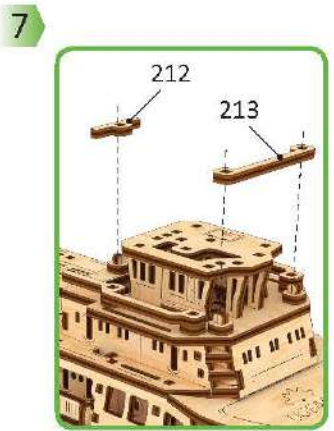
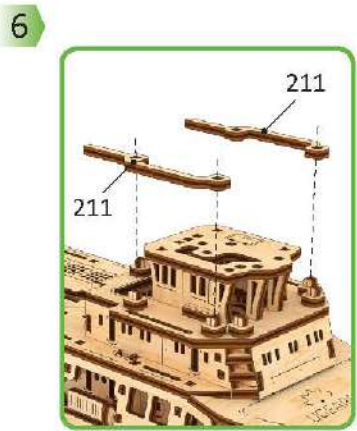
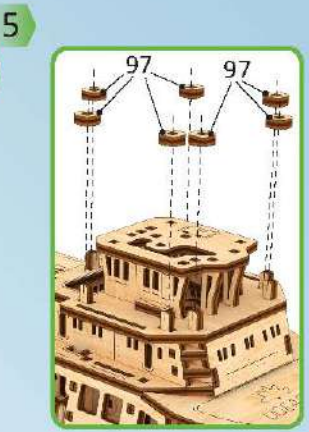
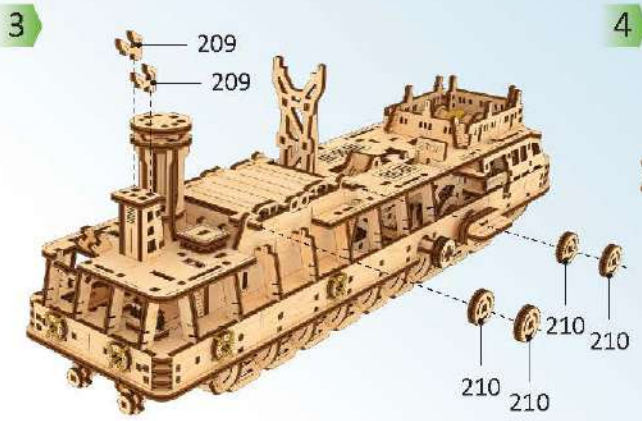
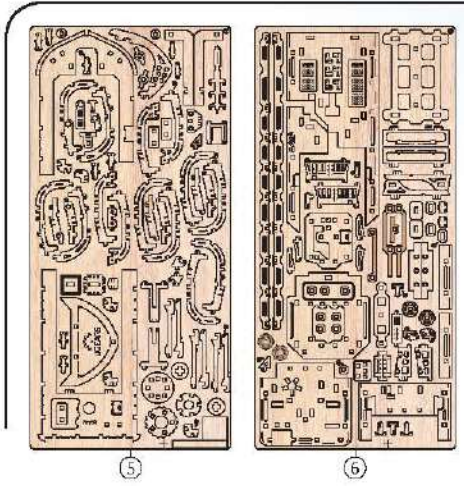

11

q6

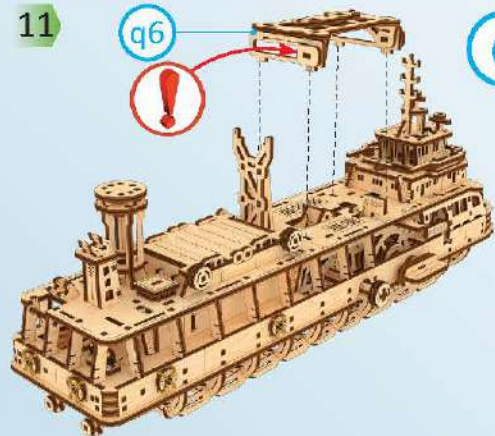

Q

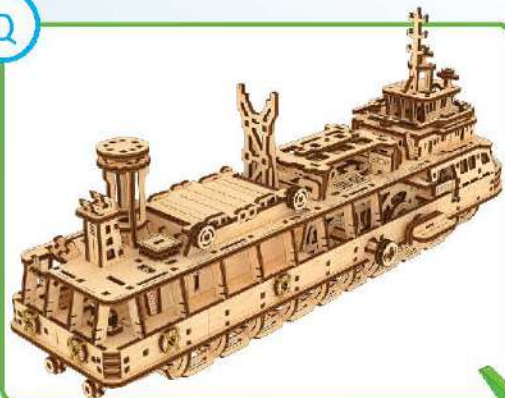

Nylon thread



1



l≈9.8"/
250mm

Q

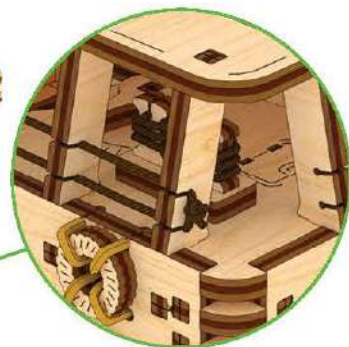
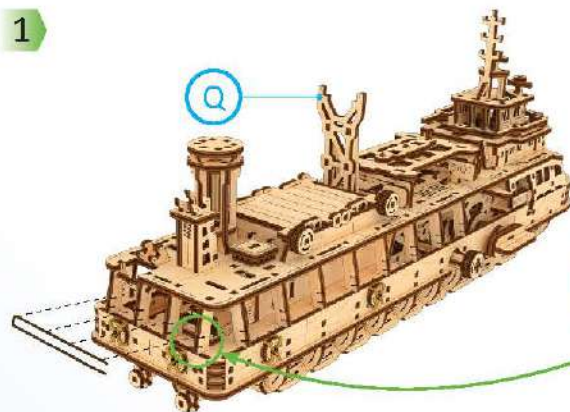

2

Nylon thread



l≈21.6"/
550mm

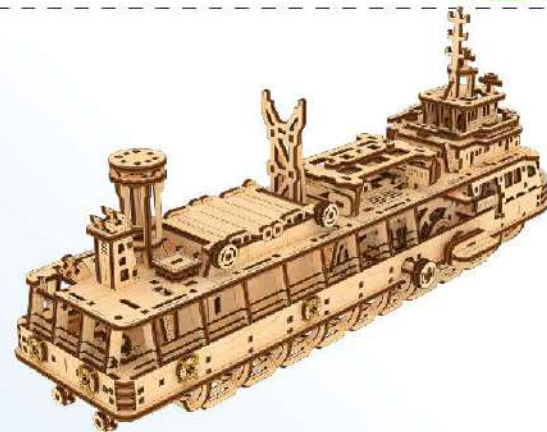
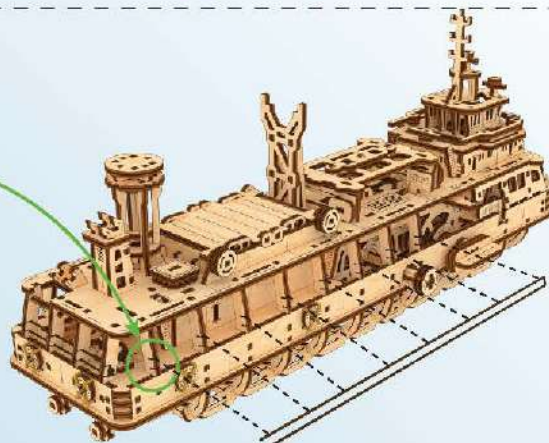

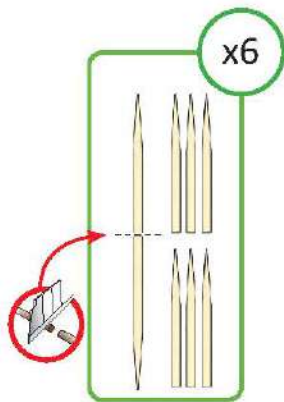
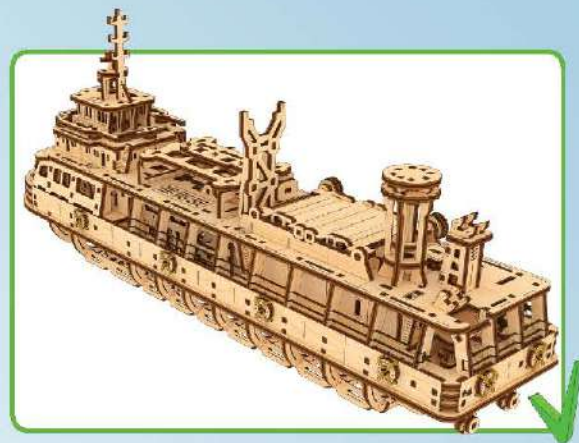
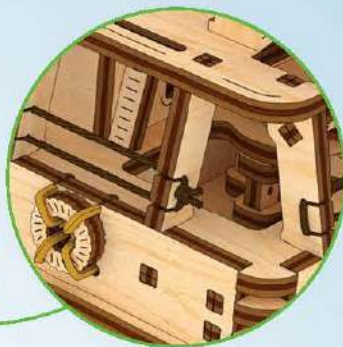
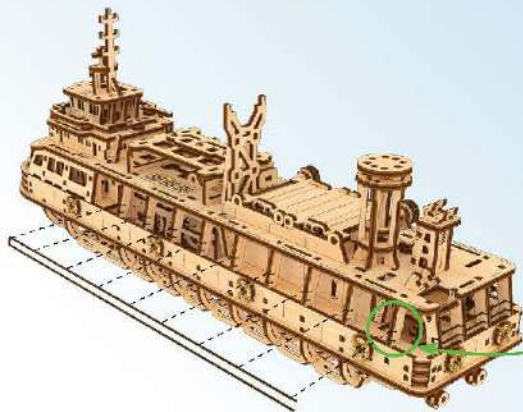
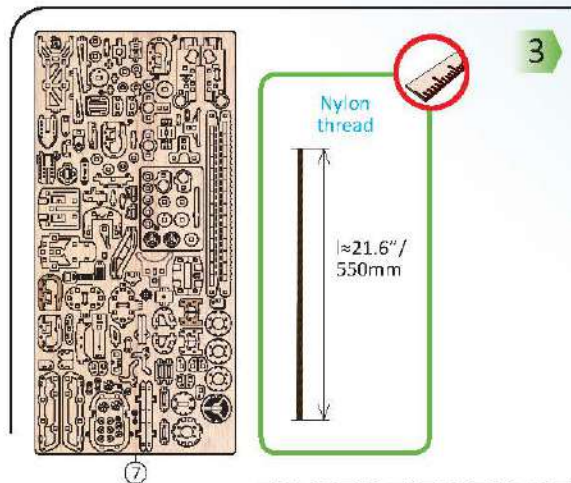

1

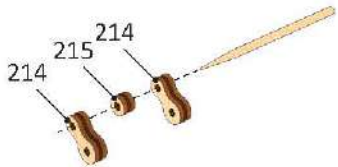

2

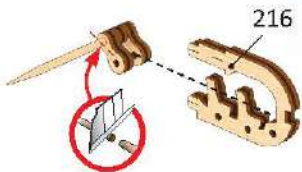

3



4

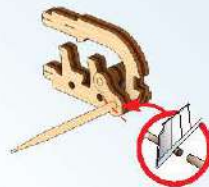

5

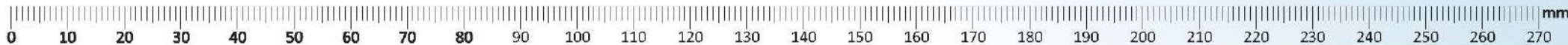
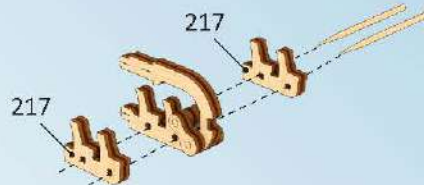

6

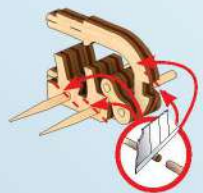

r1



1

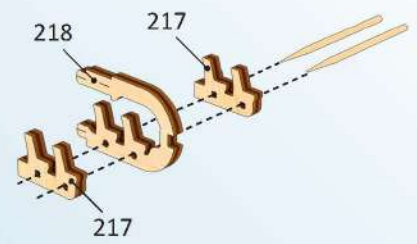

2

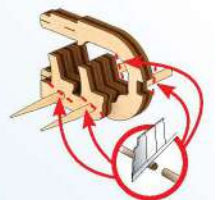

r2



1

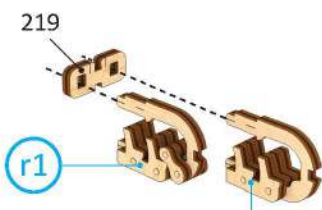

r1

r2

2

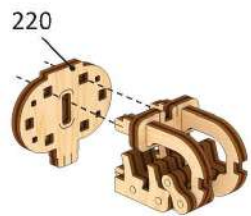

3

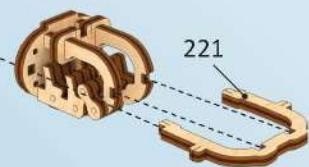

R



x7

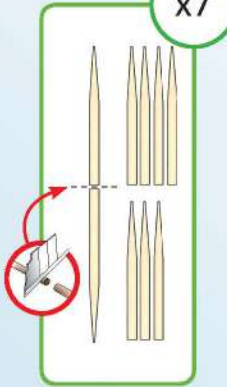

1

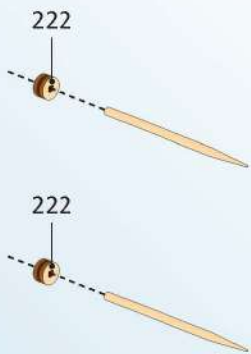

2

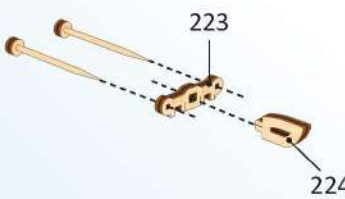

3

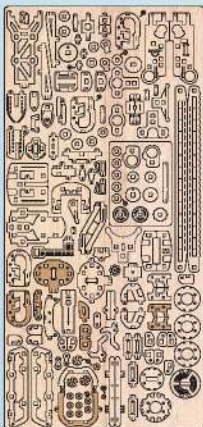
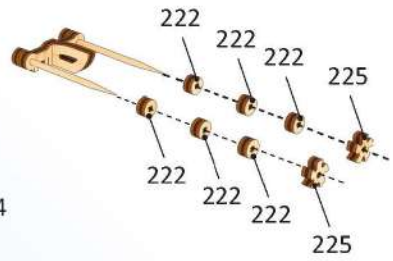

44

7

4

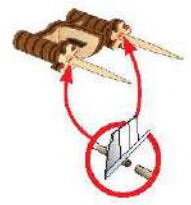

5

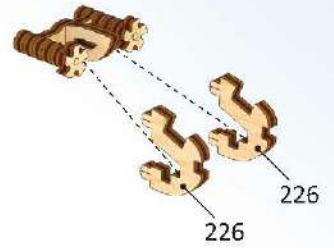

6

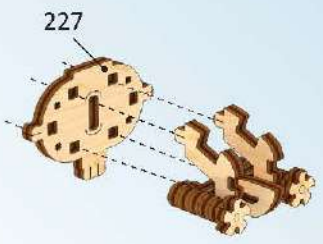

7

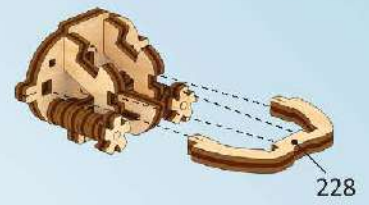

8

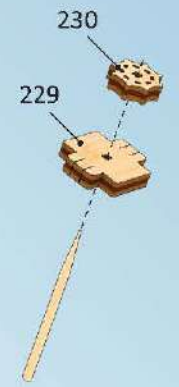

9



10



11

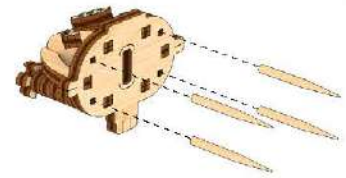

12

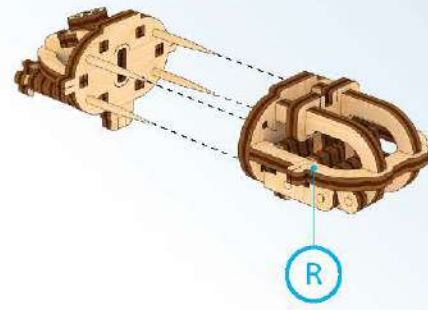

13

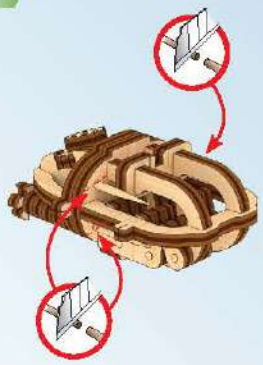

S

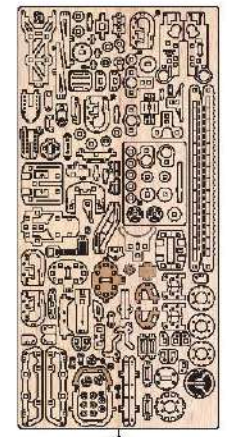

Mechanical models

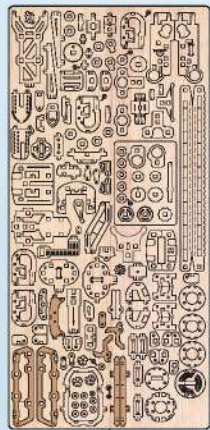

7

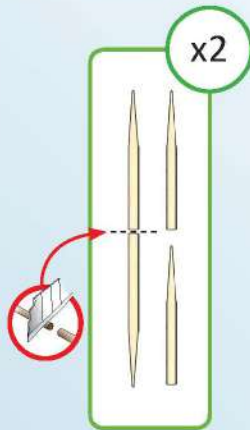

1

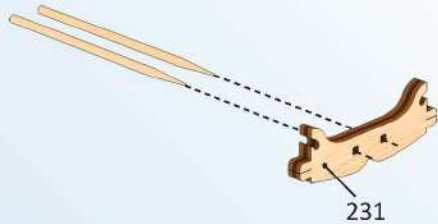

2

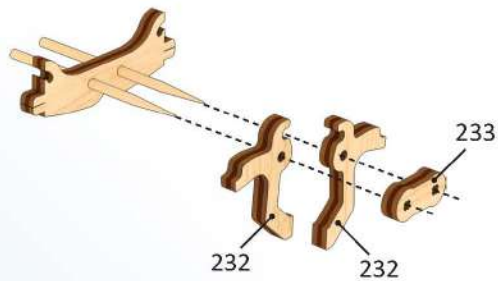

3



4

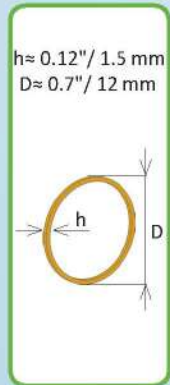

1

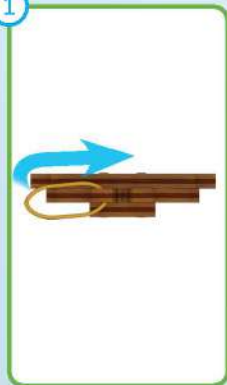

2



3



4



5

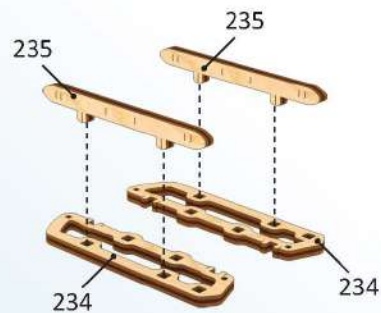

6



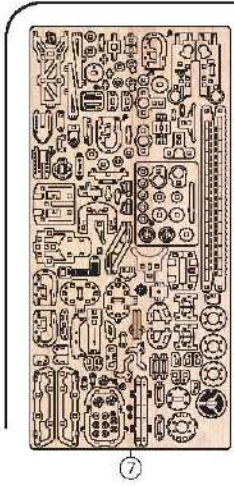

7

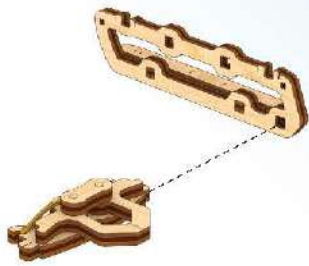

8

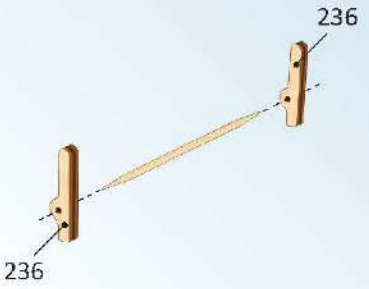

9

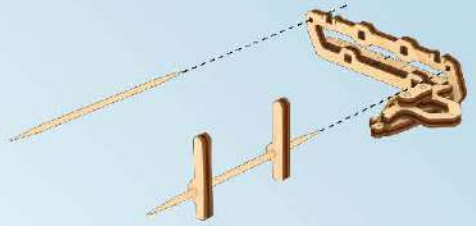

10



11

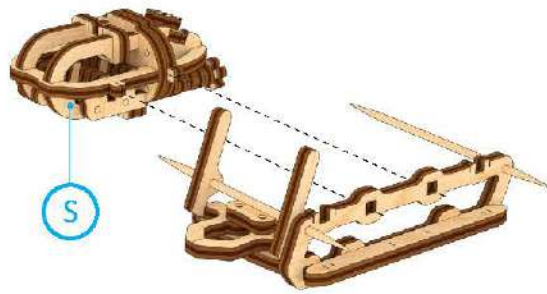

12

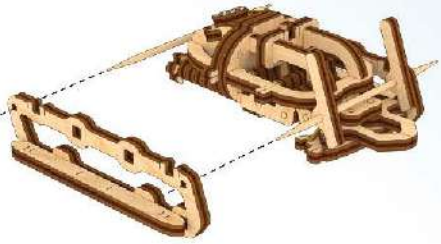

13

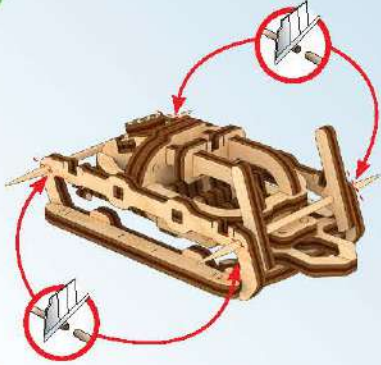

T



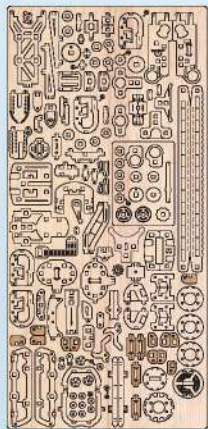

1

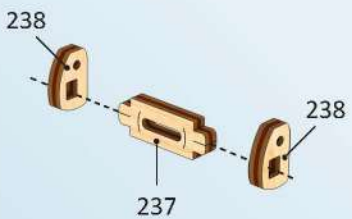

2



3



4

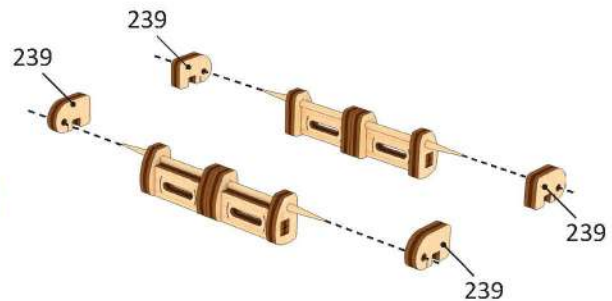

5

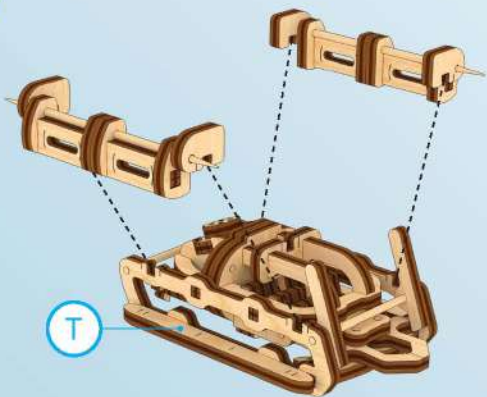

6

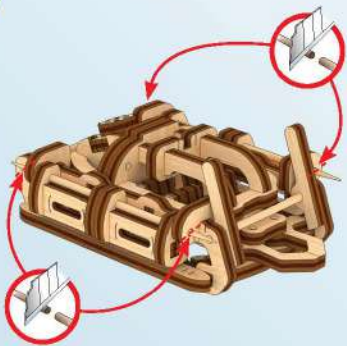

7

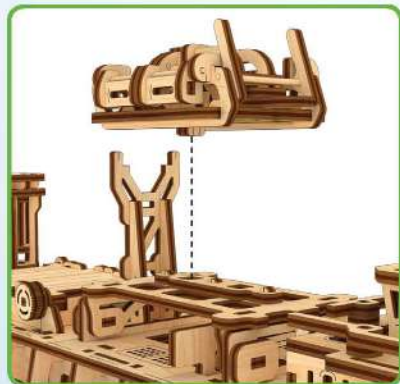

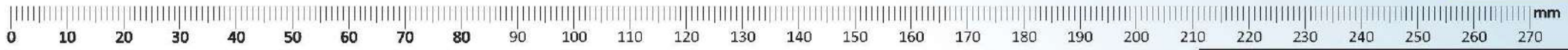
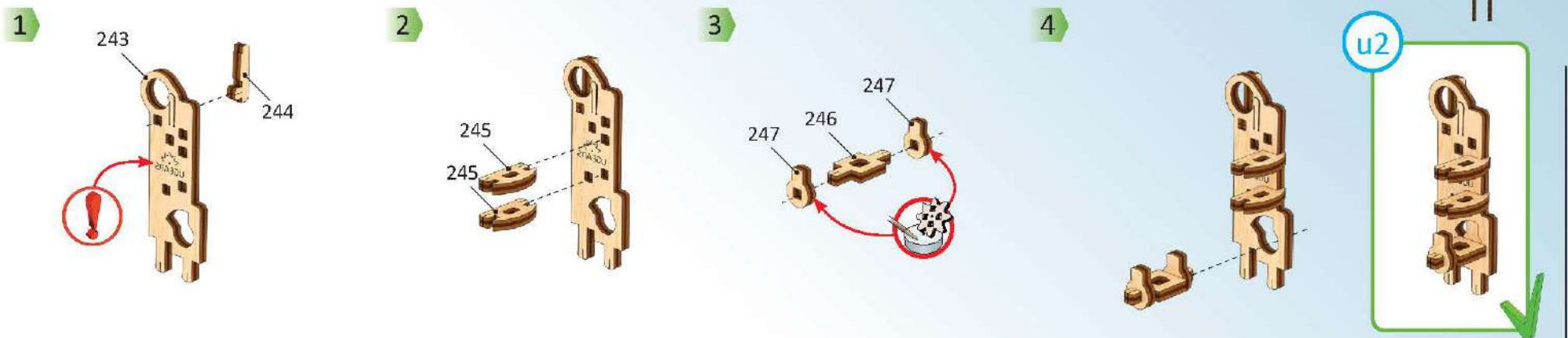
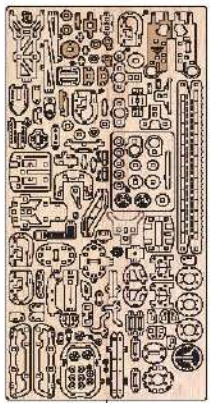
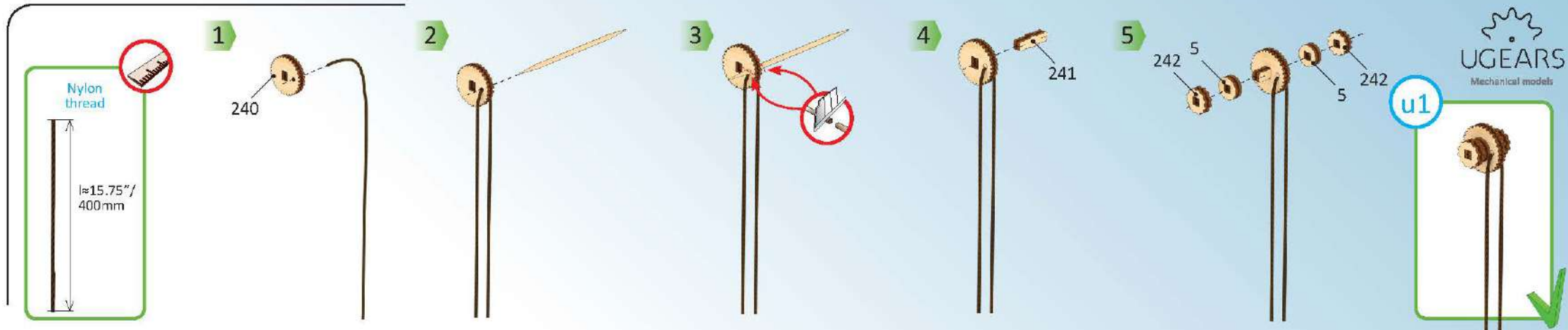

Mechanical models

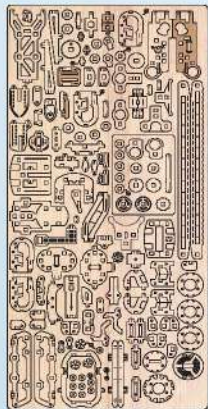

1

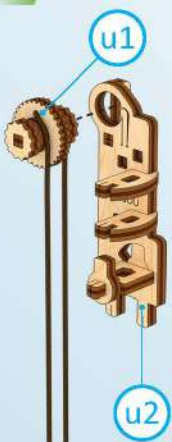

2

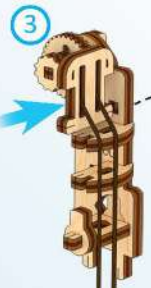
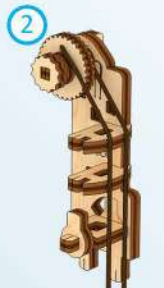

3

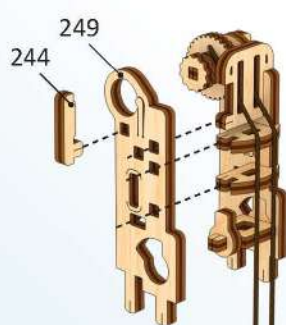

4

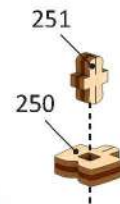

x2

5

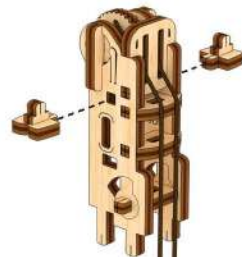

u3



248

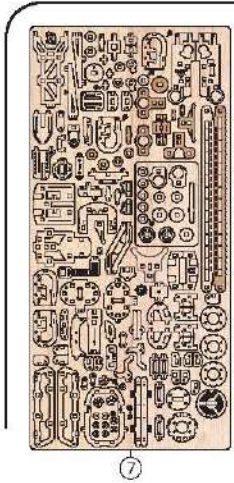

1

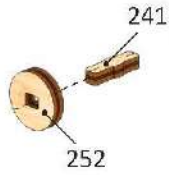

2

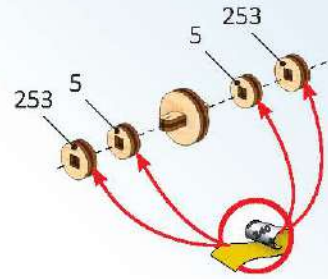

3

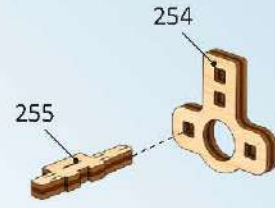

4

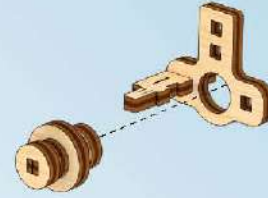

5

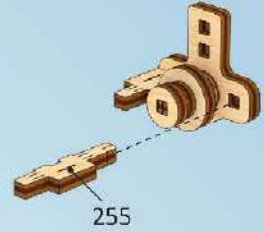

6

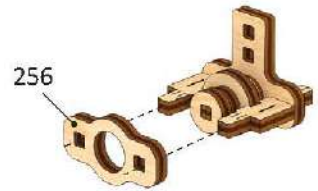

7

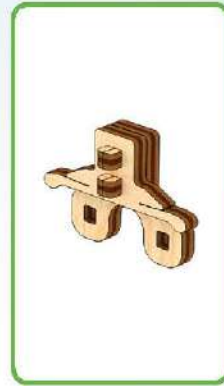
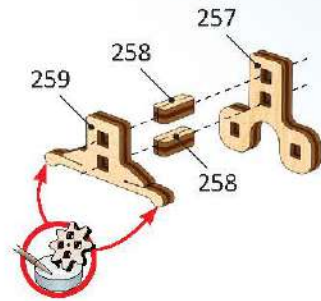

8

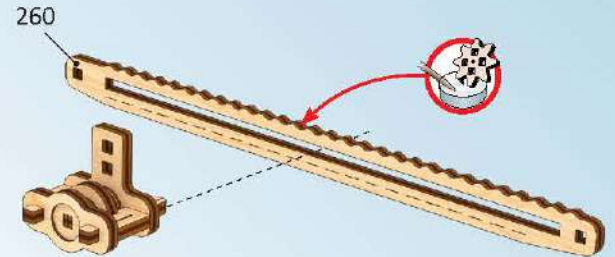

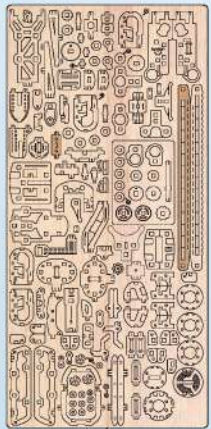

9

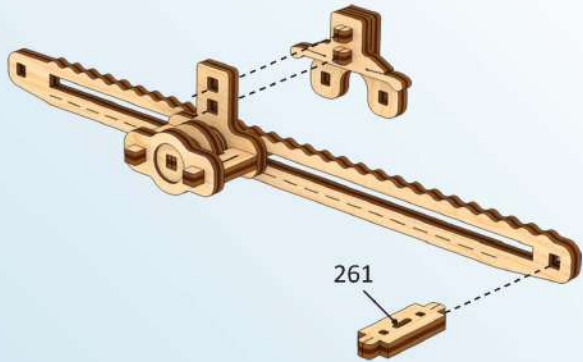

10

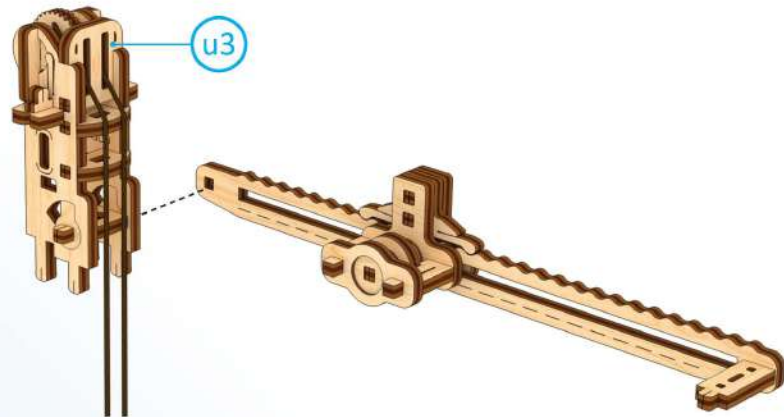

11

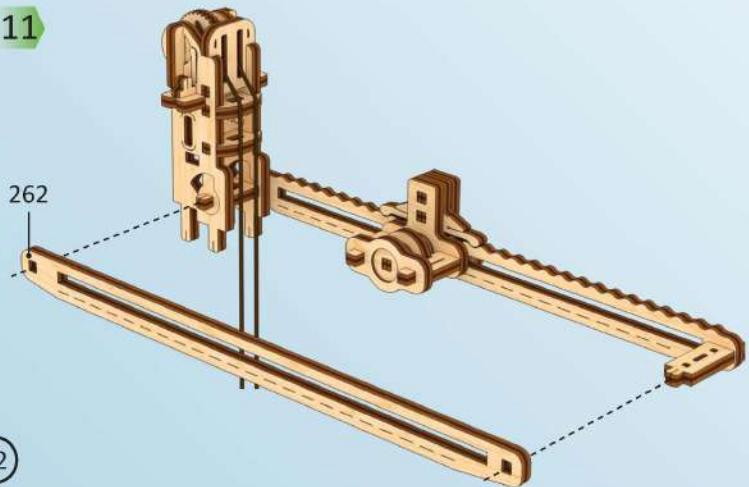

12

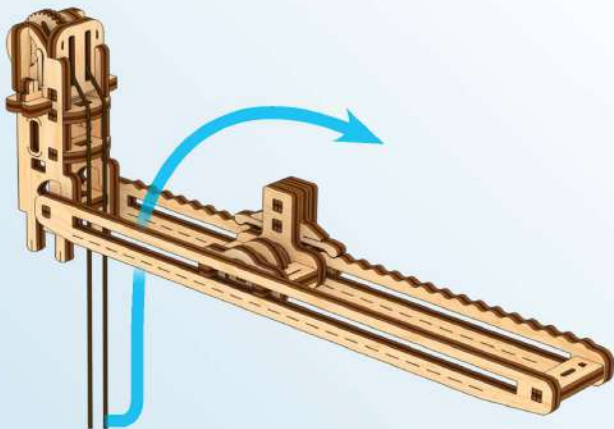

13

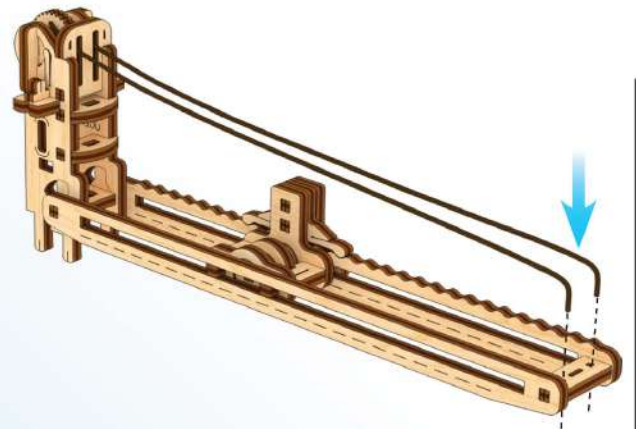

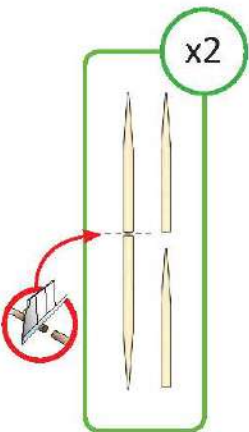

14

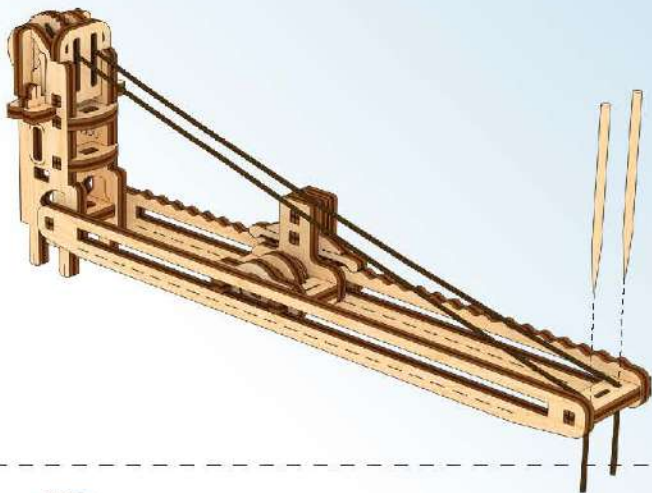

15



16

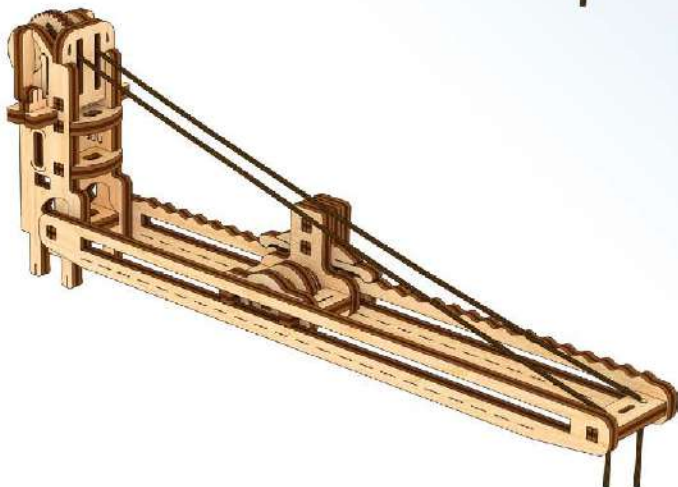

u4



Mechanical models

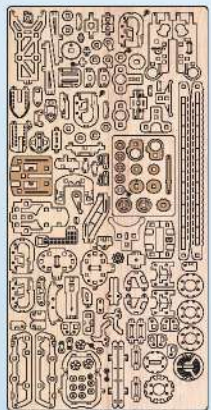

Nylon thread

$l \approx 18.9'' / 480\text{mm}$

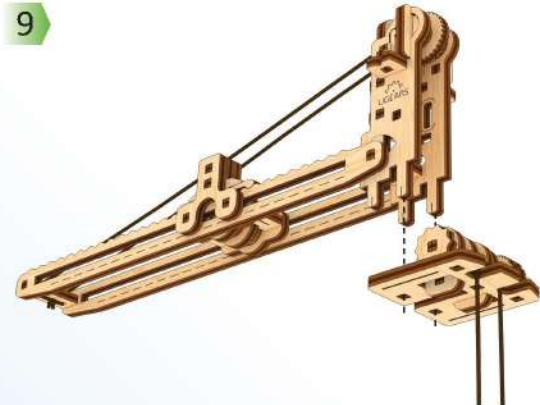
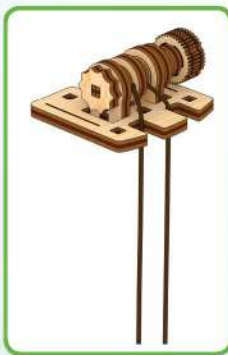
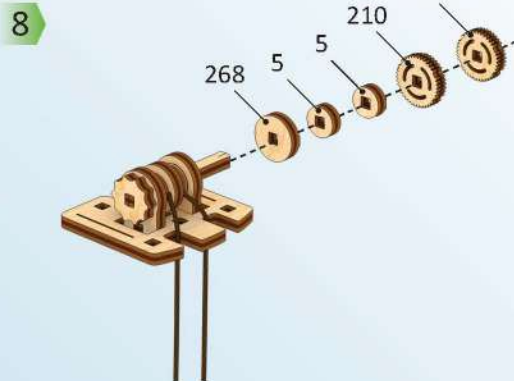
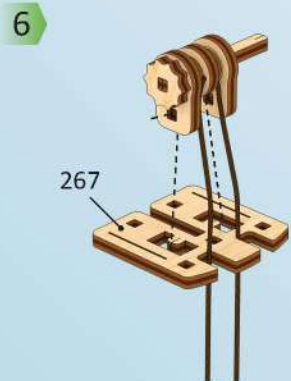
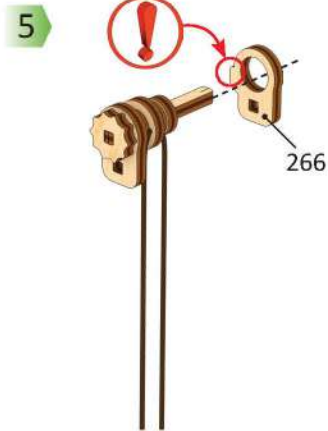
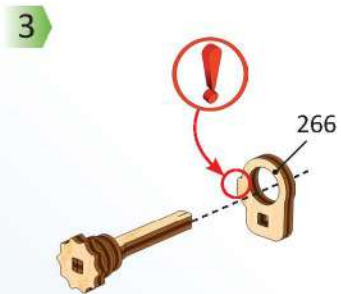
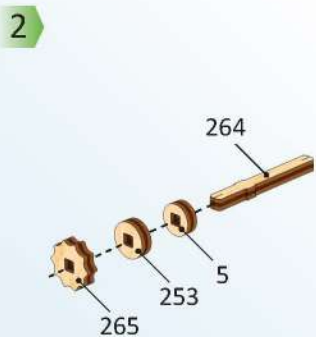

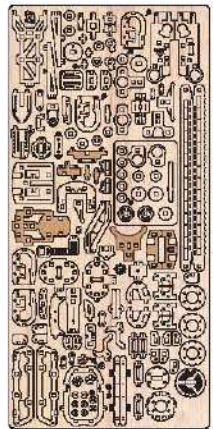

10

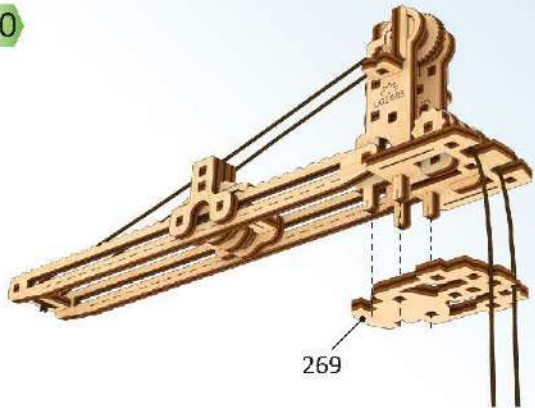

269

11

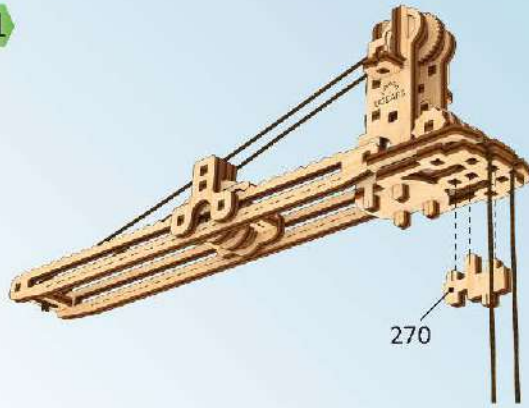

270

12

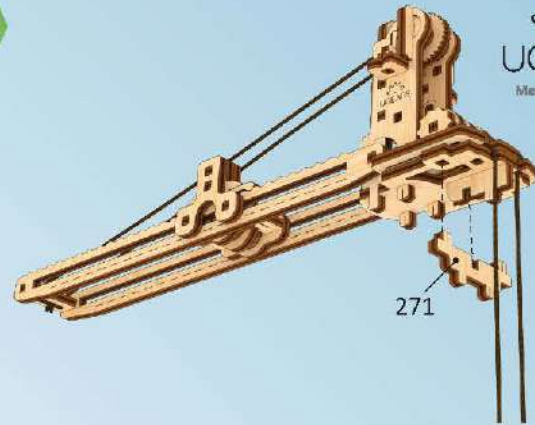

271

13

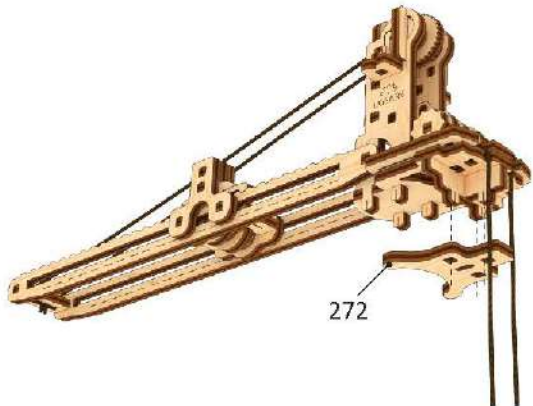

272

u5

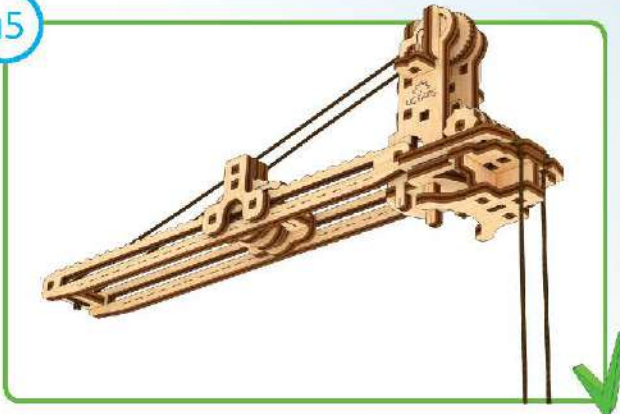

1

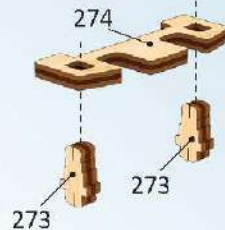

274

273

2

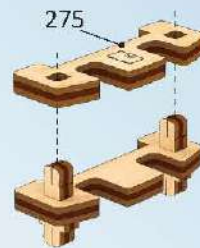

275

u6



1

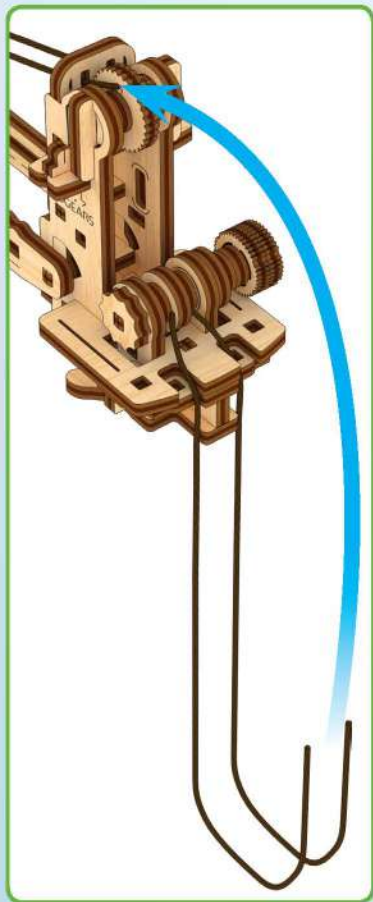

2

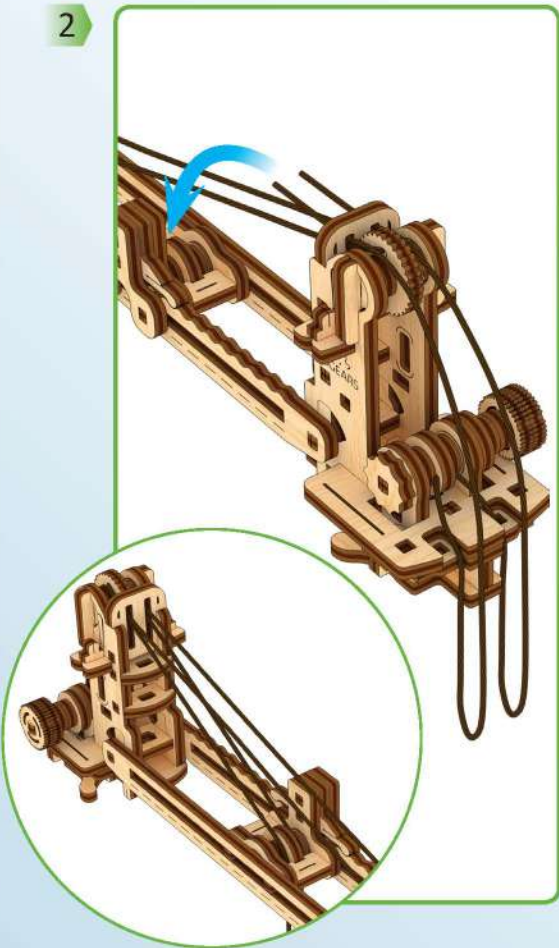

3

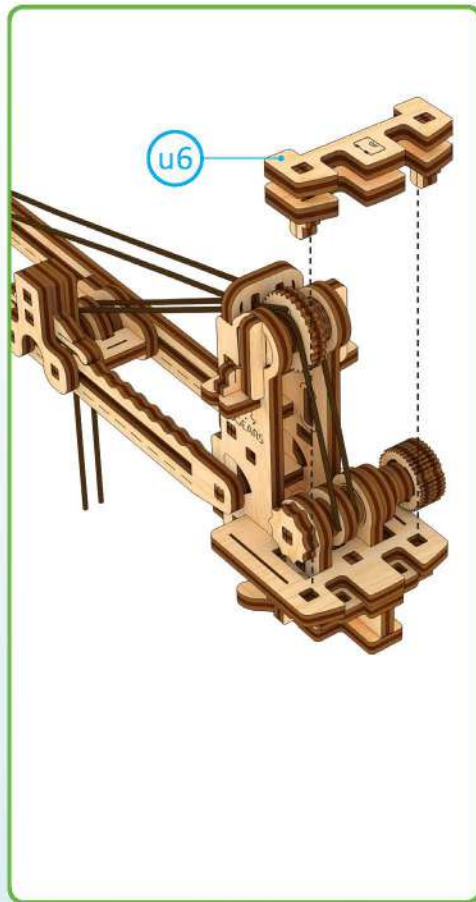

4

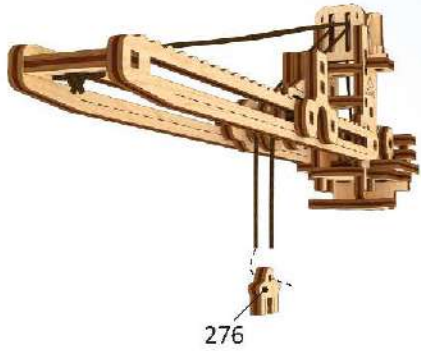

5

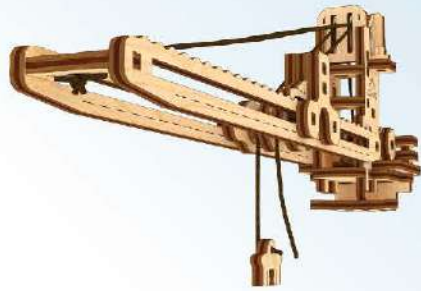

6

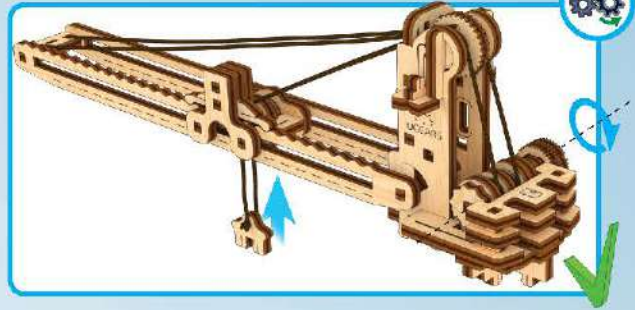
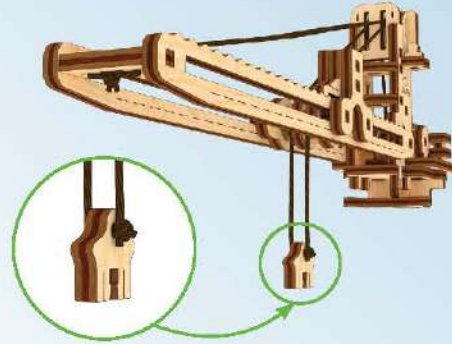

1

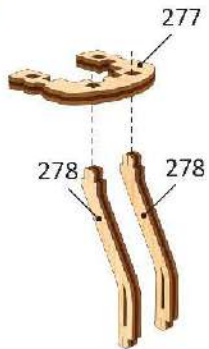

2

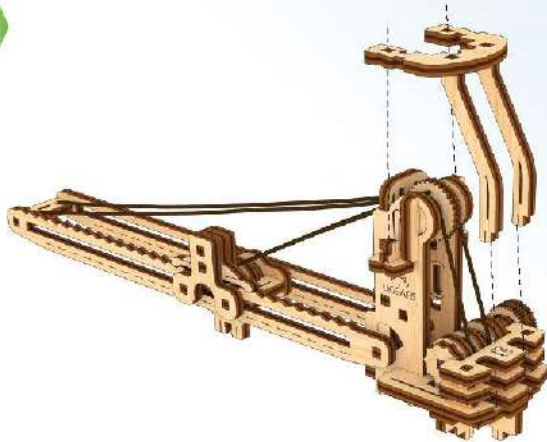

3

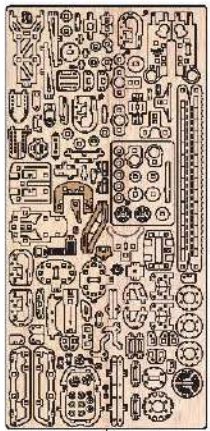
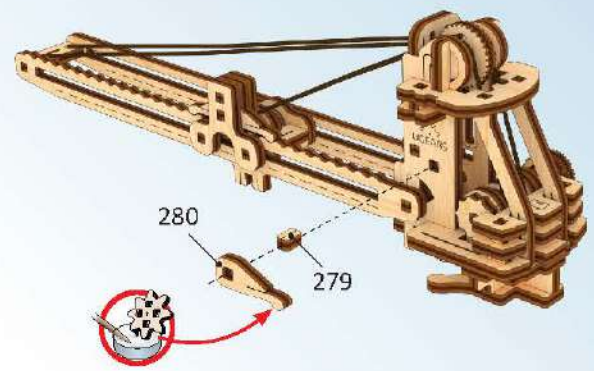

7

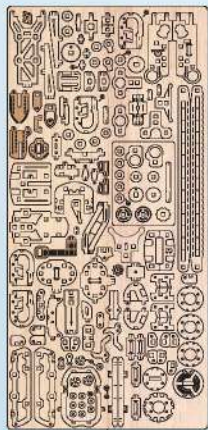

4

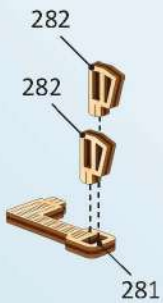

5

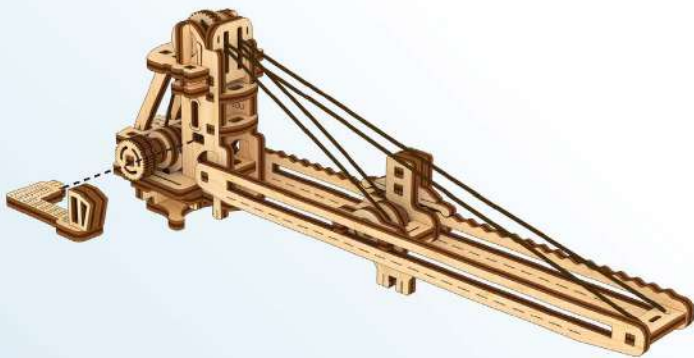

U

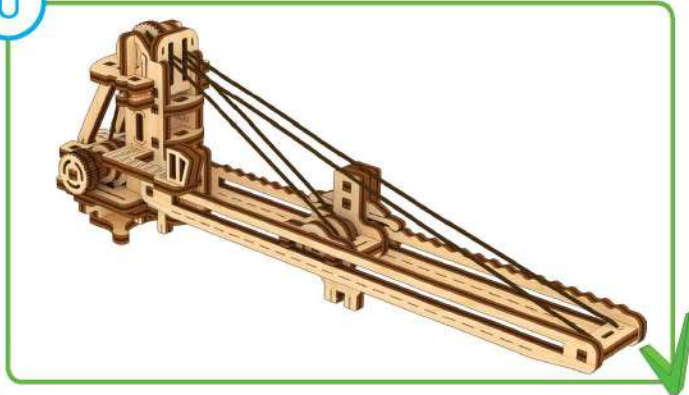

x1

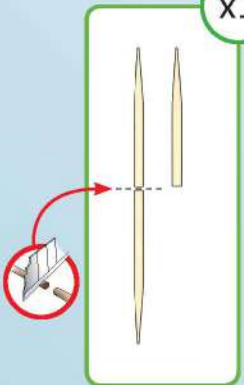

1



2



3



4



v1



1

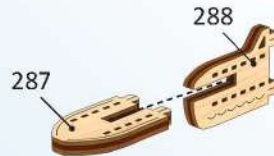

2

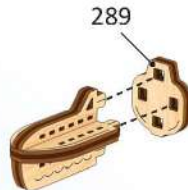

v2

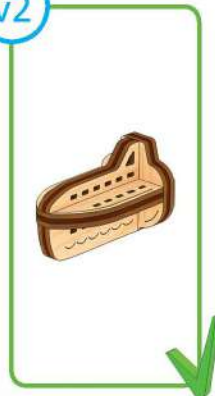

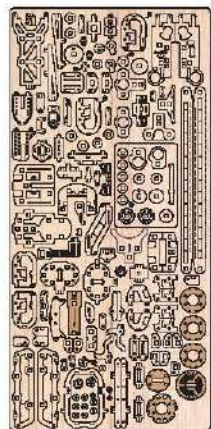
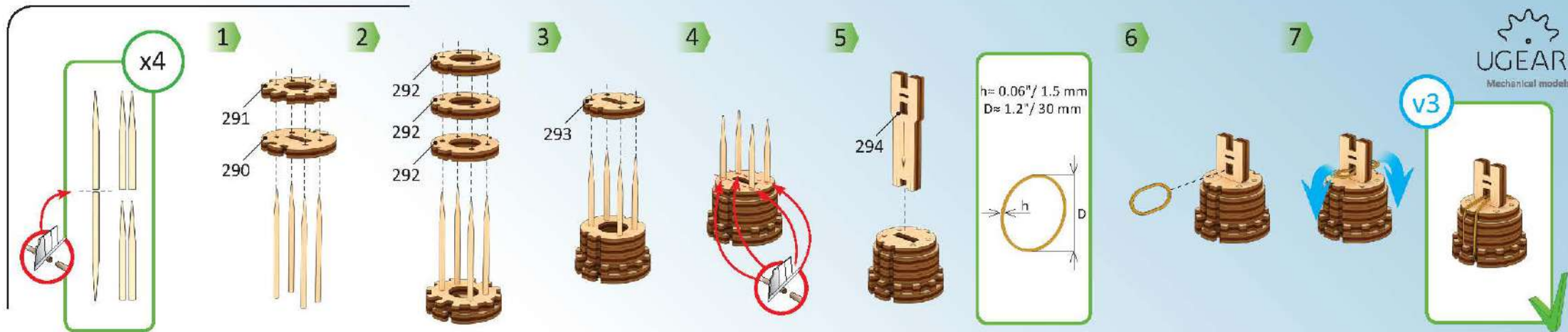

7

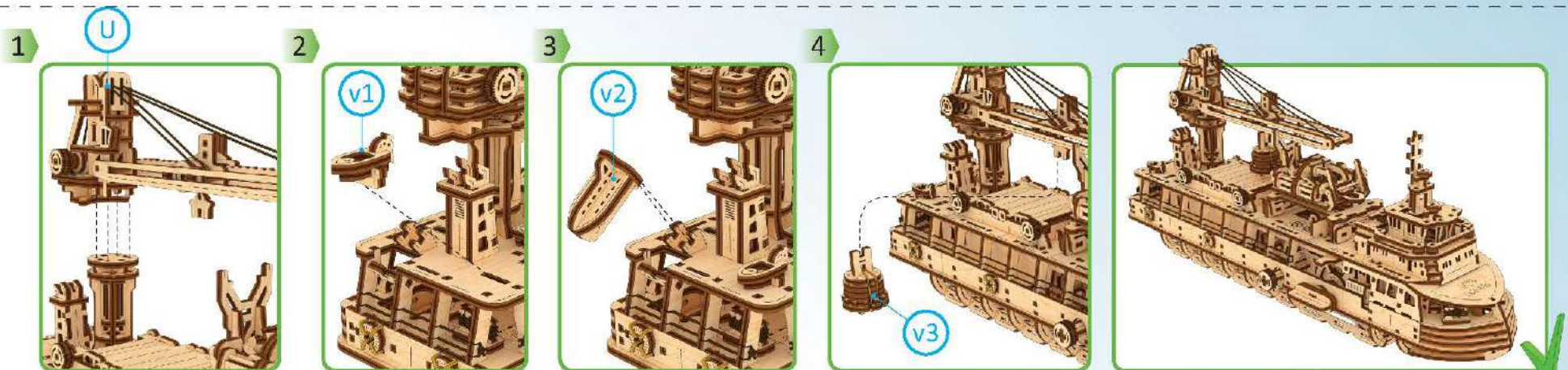

1

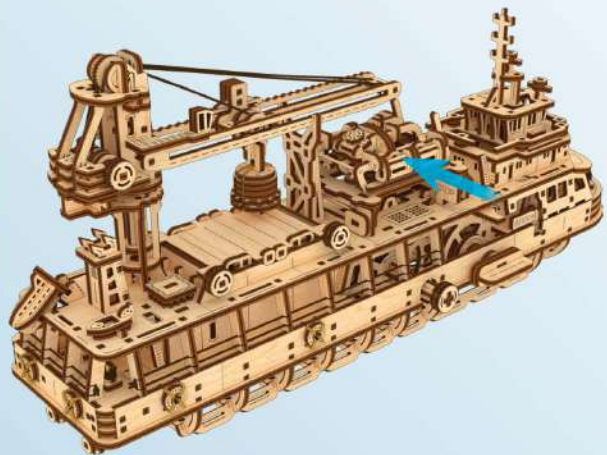

2

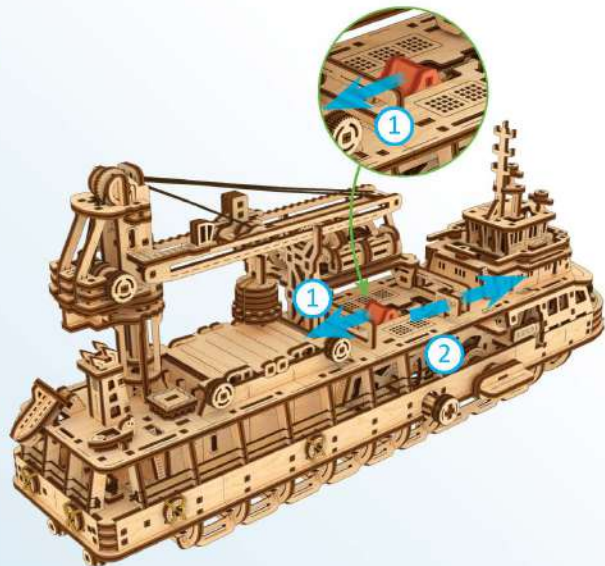

3

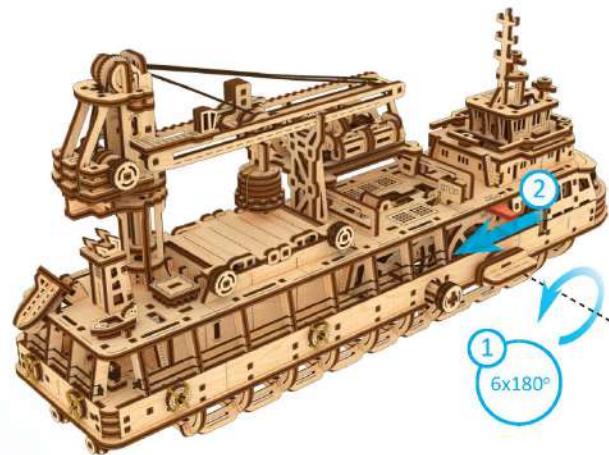

4

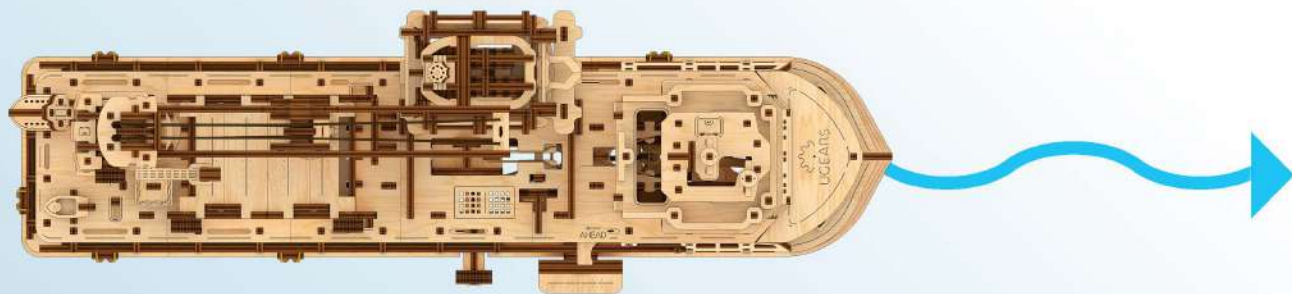

1

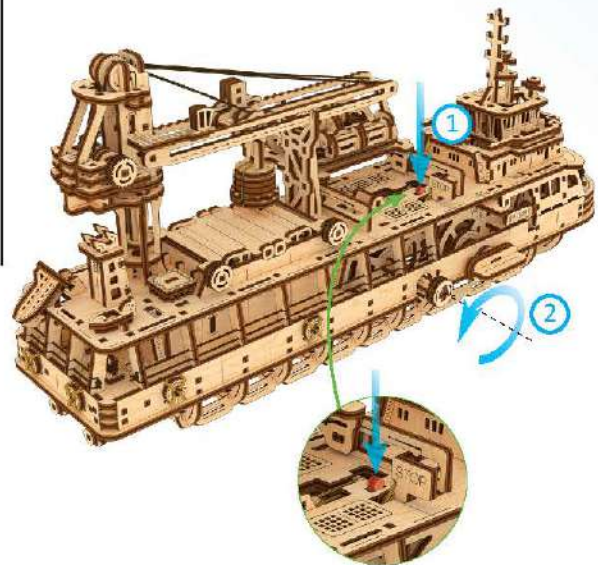

2



2

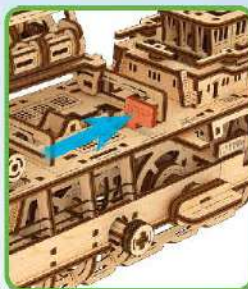

3



4

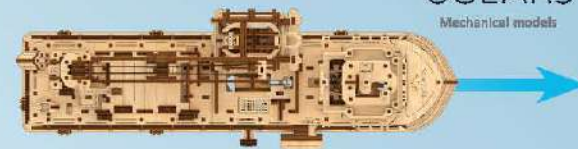

2



2



3

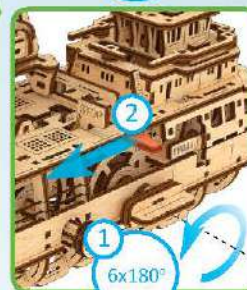

4



2



2



3

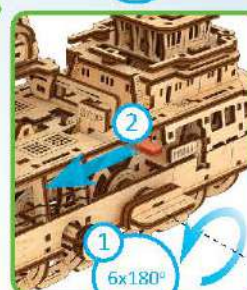

4



1

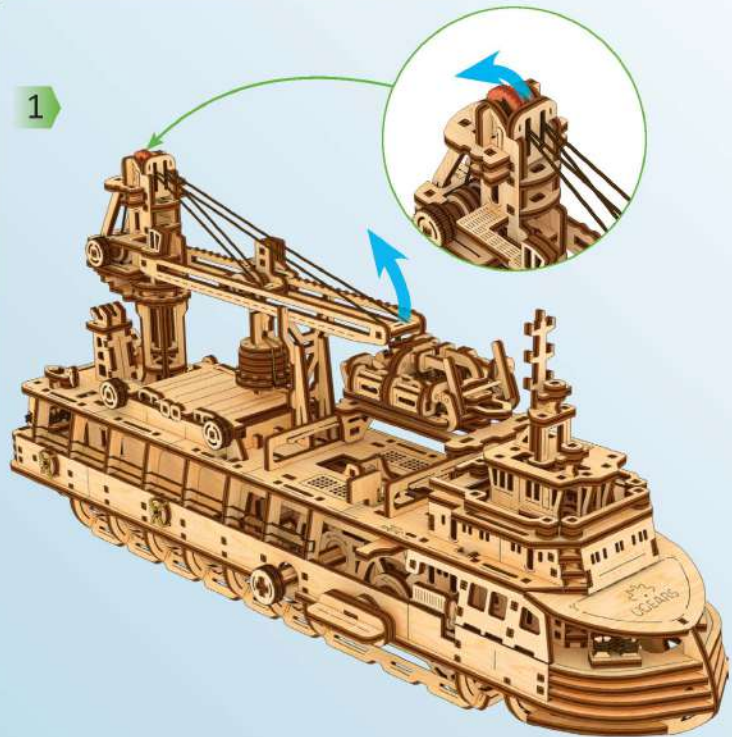

2

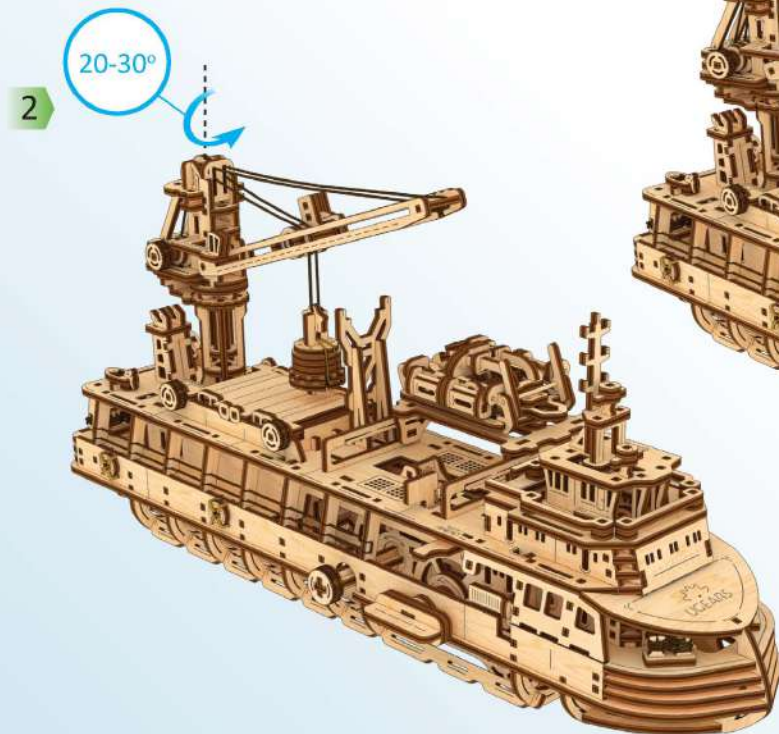

3

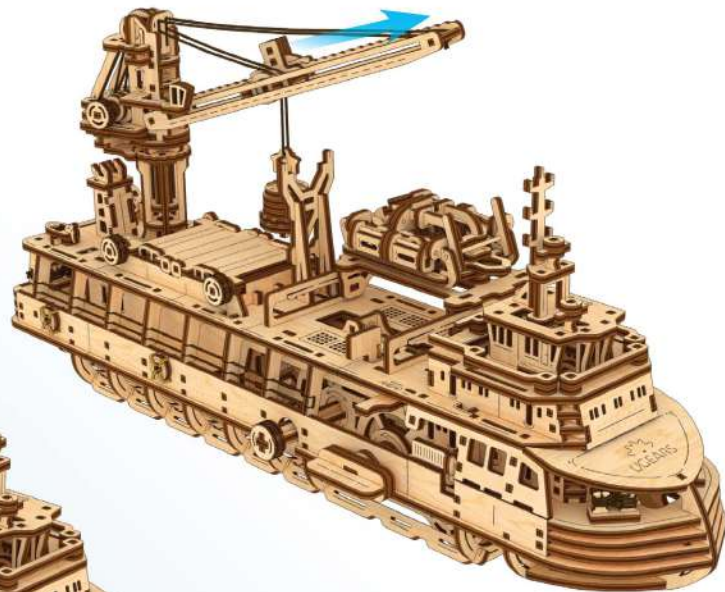

4

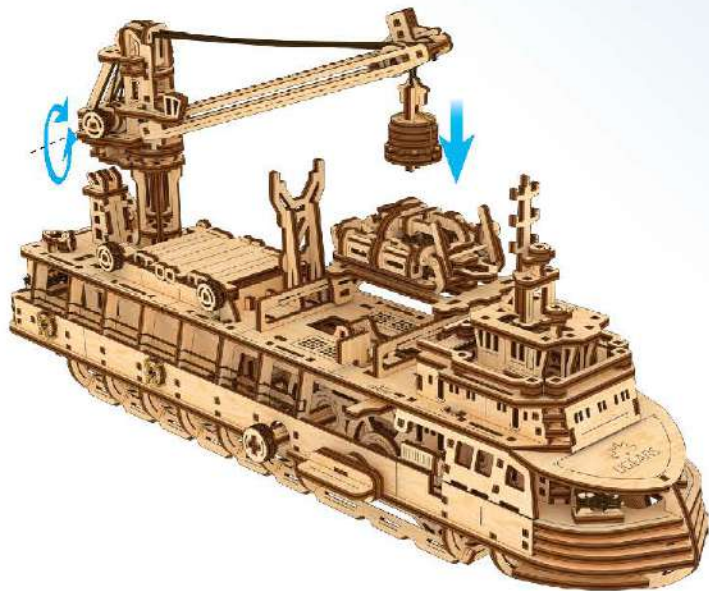

5

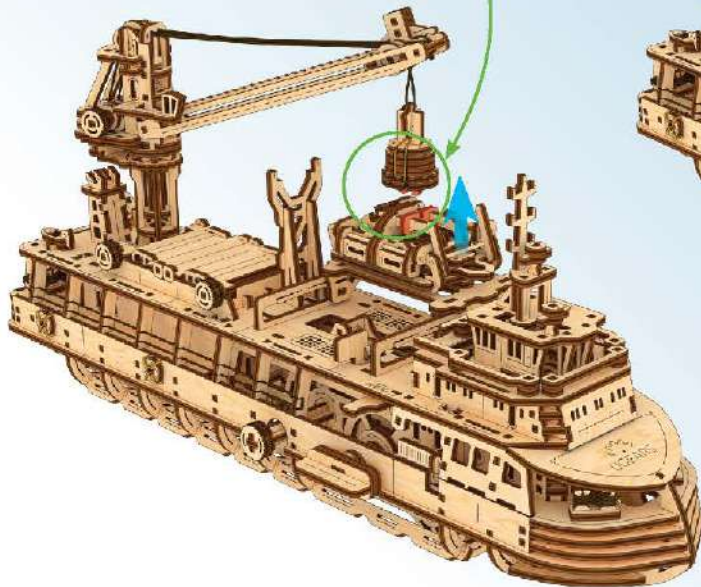

6

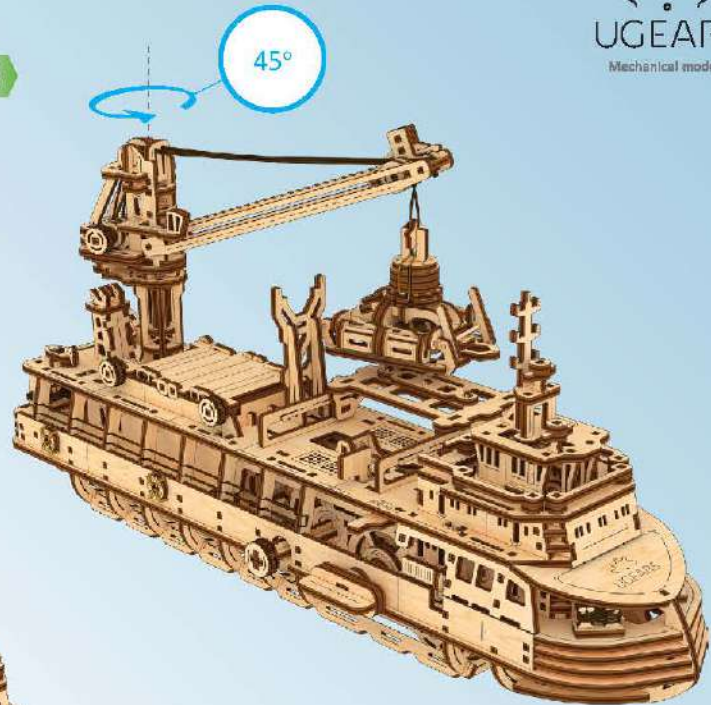

7

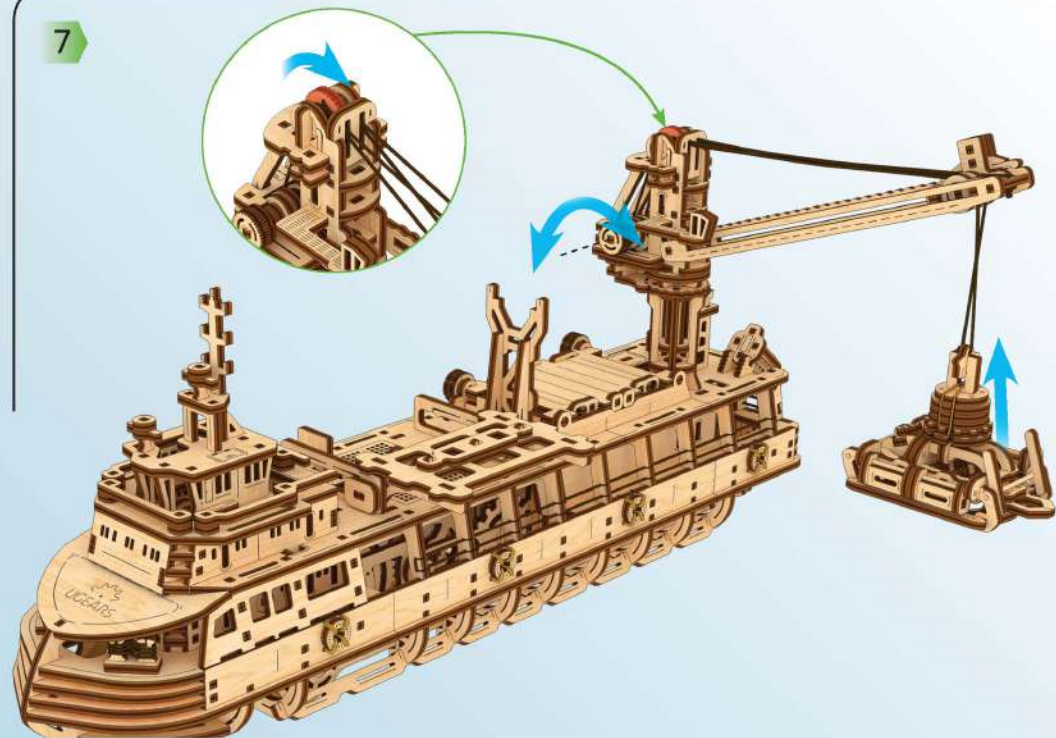

8

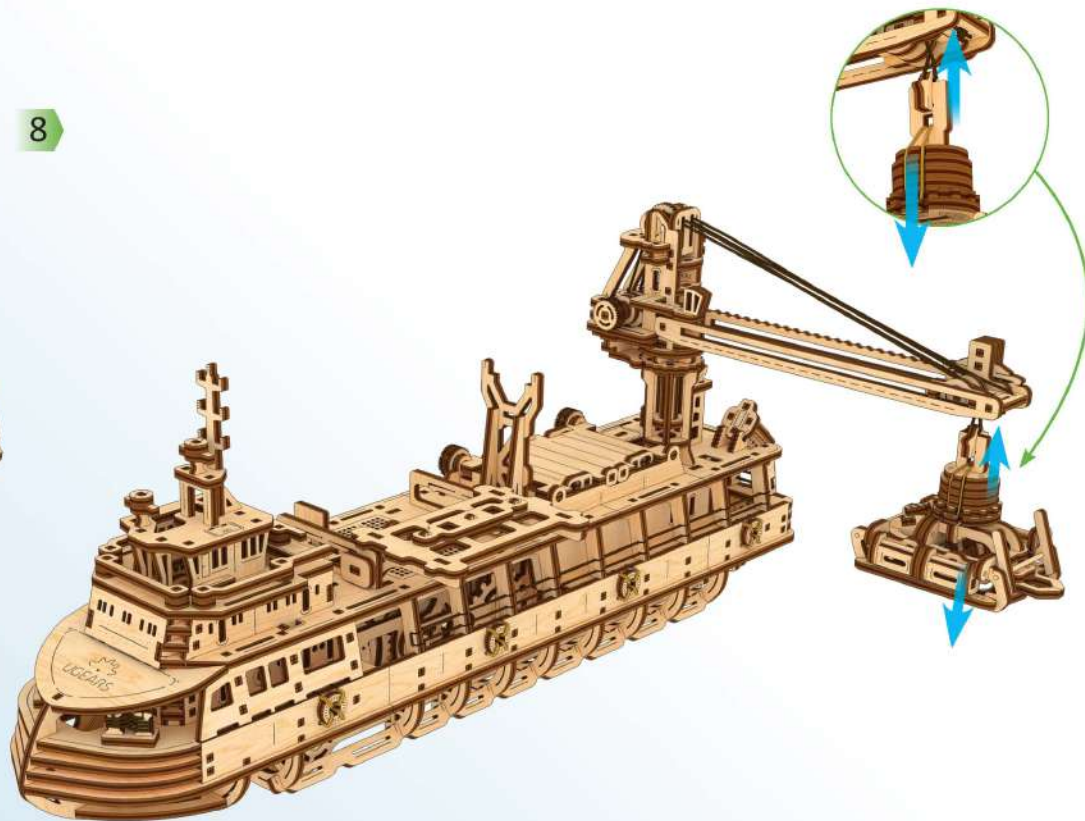

9

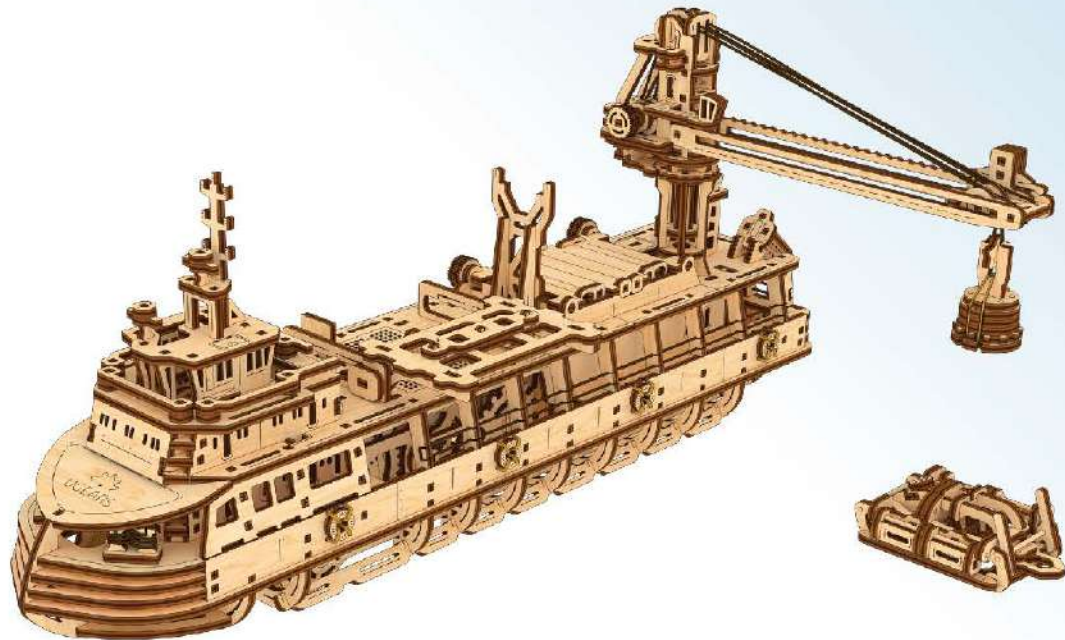

1



2



Mechanical models

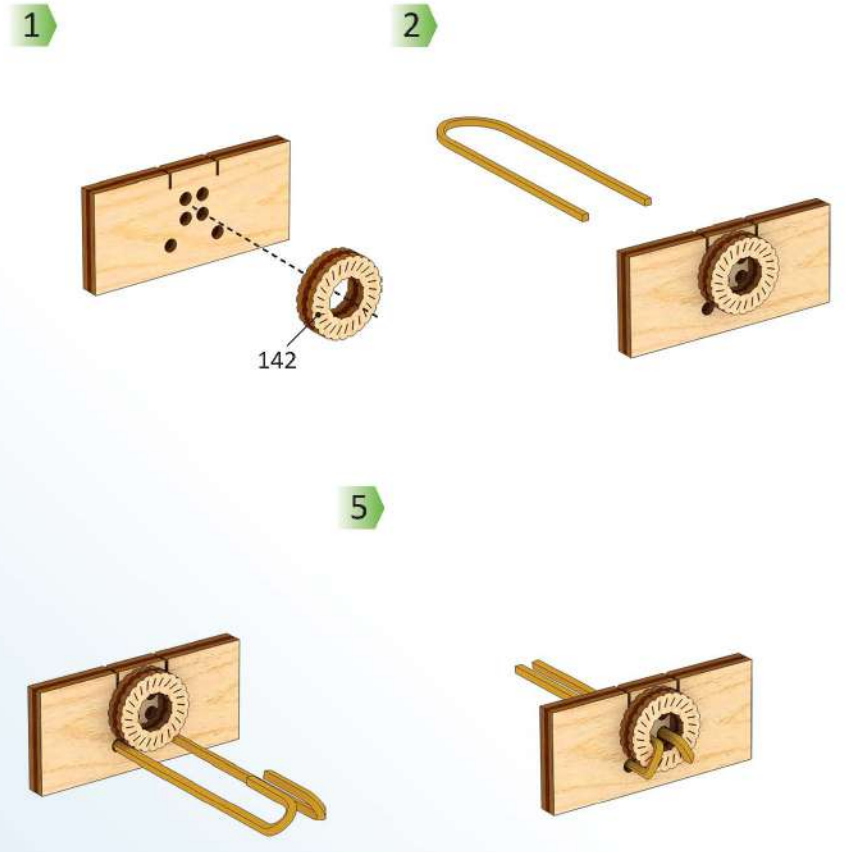
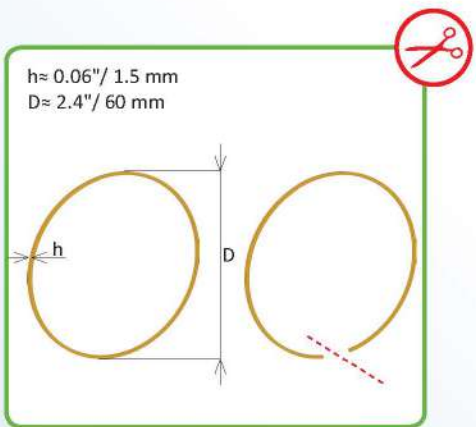
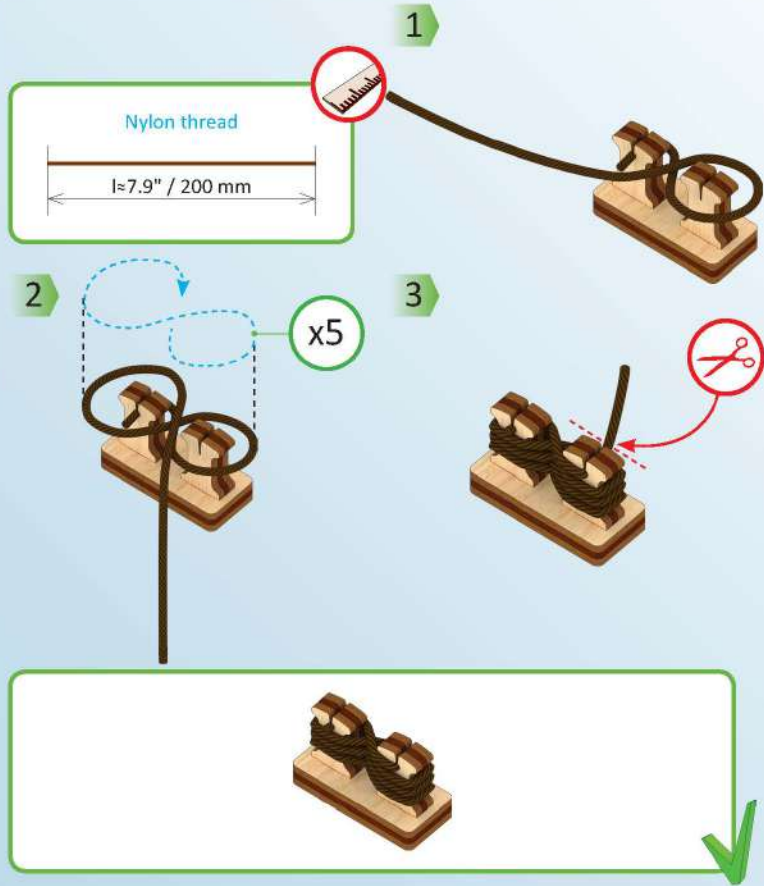

6



7

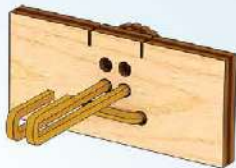

8

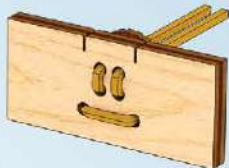

9

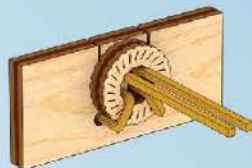

10

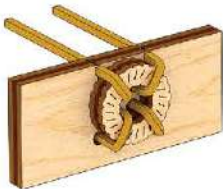

11





Watch the
VIDEO



UGEARS®
Mechanical models

ENG Thanks for following along on this journey with us.

UKR Дякуємо, що ви пройшли цей шлях з нами.

DEU Vielen Dank, dass Sie diesen Weg mit uns gegangen sind.

FRA Merci denous avoir accompagnés tout au long de ces étapes.

POL Dziękujemy, że razem z nami pokonałeś tę drogę!

SPA Gracias por haber recorrido el camino con nosotros.

ITA Grazie per aver fatto uesto percorso con noi.

RUS Спасибо, что вы прошли этот путь с нами.

JAP UGEARSをご利用いただきありがとうございます

KOR UGEARS와 함께해 주셔서 감사합니다.

CHI 感谢您参与有趣的模型拼装过程。

ugearsmodels.com

ENG Customer support **UKR** Служба підтримки

DEU Kundendienst **FRA** Service client

POL Wsparcie klienta **SPA** Servicio al cliente

ITA Servizio di supporto **RUS** Служба поддержки

JAP お客様窓口 **KOR** 고객센터 **CHI** 客户支持

customerservice@ugearsmodels.com